

# **CAST IRON SOIL PIPE AND FITTINGS HANDBOOK**

Revised and Edited  
under the direction of the  
**TECHNICAL ADVISORY GROUP**  
of the  
**CAST IRON SOIL PIPE INSTITUTE**

**CAST IRON SOIL PIPE INSTITUTE**  
5959 Shallowford Road, Suite 419  
Chattanooga, Tennessee 37421  
(423) 892-0137  
[www.cispi.org](http://www.cispi.org)

CAST IRON SOIL PIPE AND FITTINGS  
HANDBOOK

Copyright© 1967, 1972, 1976, 1989, 1990, 1992, 1994, 1998, 2002, 2006 by the Cast Iron Soil Pipe Institute. Printed in the United States of America. All rights reserved. This book or parts thereof may not be reproduced in any form without permission of the publisher.

Twelfth Printing 2006

LIBRARY OF CONGRESS  
CATALOG CARD NUMBER 86-071884  
PRICE: \$50.00

## **PREFACE**

Publication of this edition has been sponsored by the Cast Iron Soil Pipe Institute to provide a reference handbook that fully meets the needs of those requiring information on the industry's products. It was compiled and edited by the Technical Advisory Group of the Cast Iron Soil Pipe Institute, and the content has benefited from the collaborative effort of its members and their experience in the manufacture and application of cast iron soil pipe and fittings. This publication is subject to periodic revision, and the latest edition may be obtained from the Cast Iron Soil Pipe Institute.

# 50<sup>TH</sup> YEAR ANNIVERSARY 1949-1999

The year is 1949 . . . . . The minimum wage is increased from 40 to 70 cents per hour, the New York Yankees win the World Series, Billy Joel, Bruce Springsteen, Tom Watson, and Meryl Streep are born. Babe Ruth dies at age 53, Harvard Law School admits their first women, gold is \$35 an ounce and a new house is \$7,450 . . . . and the Cast Iron Soil Pipe Institute is born. A group of 24 manufacturers of cast iron soil pipe and fittings meet at the Roosevelt Hotel in New Orleans, Louisiana. These pioneers identify the need to standardize product design to aid interchangeability of different manufacturers' pipe and fittings, the need for distribution of product information to aid specifiers and designers, and the continuing education of specifiers, installers, and inspectors of the benefits of using cast iron soil pipe and fittings. These goals have been the focus of the Institute for over 50 years.

**Roosevelt Hotel**  
New Orleans, Louisiana  
March 21, 1949

**Alabama Pipe Co.**  
Anniston, Alabama  
Charles A. Hamilton

**Buffalo Pipe & Foundry Co.**  
Buffalo, New York  
Cameron Baird  
Phillip J. Faherty

**American Brass & Iron Foundry**  
Oakland, California  
Arnold Boscacci

**Central Foundry Co.**  
New York, New York  
J.J. Nolan, Jr.  
Paul Singleton  
Harry Maasen

**Anniston Foundry Co.**  
Anniston, Alabama  
William H. Deyo  
William T. Deyo

**Charlotte Pipe & Foundry Co.**  
Charlotte, North Carolina  
Frank Dowd

**Anniston Soil Pipe Co., Inc.**  
Anniston, Alabama  
R.M. Blakely

**Clay Bailey Mfg. Co.**  
Kansas City, Missouri  
George Clay

**Attalla Pipe & Foundry Co.**  
Attalla, Alabama  
Joseph M. Franklin  
William B. Neal



**50<sup>TH</sup> YEAR ANNIVERSARY 1949-1999**

**Combustion Engineering-  
Superheater, Inc.**

Chattanooga, Tennessee  
E.J. McFadden  
S.C. Northington  
A.J. Moses

**Eastern Foundry Co.**  
Boyertown, Pennsylvania  
George L. Harberger  
Earl H. Walt

**East Penn Foundry Co.**  
Macungie, Pennsylvania  
Howard M. Singmaster

**Emory Pipe & Foundry Co.**  
Anniston, Alabama  
G.F. Shackelford

**Hajoca Corp.**  
Lansdale, Pennsylvania  
Deems W. Hallman

**T.C. King Pipe & Foundry Co., Inc.**  
Anniston, Alabama  
T.C. King  
Joseph King  
A. Quinn

**Reading Foundry Co.**  
Reading, Pennsylvania  
William M. Davies

**Rich Mfg. Co. of California**

Los Angeles, California  
J.W. Struve  
Ed Alt

**Rudisill Foundry Co.**

Anniston, Alabama  
Frank T. Hamilton  
Dean Helle  
Lindsay Builder

**Russell Pipe & Foundry Co.**

Alexander City, Alabama  
J.F. Weathers

**Sanitary Co. of America**

Linfield, Pennsylvania  
Harvey D. Ritter  
William Davis

**Somerville Iron Works**

Somerville, New Jersey  
David B. Shannon  
R.N. Hickey

**Tyler Pipe & Foundry Co.**

Tyler, Texas  
Mike Harvey

**Walker Foundry & Machine Co.**

Roanoke, Virginia  
William Hayes

**Williamstown Foundry Corp.**

Williamstown, New Jersey  
Walter Schaufler

# TABLE OF CONTENTS

	Page
<b>TABLE OF CONTENTS</b> .....	i
<b>INTRODUCTION</b> .....	viii
The Cast Iron Soil Pipe Institute .....	viii
<b>CHAPTER I — CAST IRON SOIL PIPE HISTORY, USES AND PERFORMANCE</b> .....	1
<b>HISTORY OF CAST IRON SOIL PIPE</b> .....	1
Early Production and Use in the United States .....	2
Growth and Dispersion of Foundries, 1880-1890 .....	2
Emergence of the Cast Iron Soil Pipe Industry .....	4
<b>USES OF CAST IRON SOIL PIPE</b> .....	5
<b>REQUIREMENTS FOR A SAFE AND DURABLE DRAIN, WASTE AND VENT SYSTEM</b> .....	5
Corrosion Resistance .....	6
Expansive Soils .....	7
Resistance to Abrasion .....	7
<b>CAST IRON SOIL PIPE JOINTS AND THEIR CHARACTERISTICS</b> .....	7
Types of Cast Iron Soil Pipe and Fittings .....	8
Shielded Hubless Coupling .....	8
The Compression Joint .....	9
The Lead and Oakum Joint .....	9
Soundproofing Qualities of Cast Iron with Rubber Gasket Joints .....	9
<b>ECONOMIC ADVANTAGES OF CAST IRON SOIL PIPE</b> .....	10
Performance .....	10
Versatility .....	10
Low-Cost Installation .....	10
Product Availability .....	10
<b>CHAPTER II — THE MANUFACTURE OF CAST IRON SOIL PIPE AND FITTINGS</b> .....	11
<b>THE CAST IRON SOIL PIPE INDUSTRY</b> .....	11
Manufacturers of Cast Iron Soil Pipe and Fittings .....	11
<b>PRODUCTION OF CAST IRON SOIL PIPE AND FITTINGS</b> .....	11

TABLE OF CONTENTS

	Page
DISTRIBUTION OF CAST IRON SOIL PIPE AND FITTINGS .....	12
NUMBER OF OPERATING UNITS .....	12
THE MANUFACTURING OF CAST IRON SOIL PIPE AND FITTINGS .....	12
Types of Iron .....	12
The Modern Cast Iron Soil Pipe and Fittings Foundry .....	12
Raw Materials and Melting Devices .....	13
The Cupola Furnace for Melting Iron .....	13
The Start of the Operation of the Cupola .....	15
CASTING OF SOIL PIPE AND FITTINGS .....	16
Centrifugal Pipe Casting .....	17
Sand-Lined Molds .....	17
Metal Molds .....	18
Casting Process .....	18
STATIC CASTING OF FITTINGS .....	18
Sand Casting .....	18
Permanent Mold Casting .....	23
Cleaning and Finishing Operations .....	24
NEW TECHNOLOGY AND IMPROVEMENTS IN MANUFACTURING METHODS .....	29
The Melting Section .....	29
The Casting Section .....	29
PATTERNS FOR CAST IRON SOIL PIPE AND FITTINGS .....	29
Materials Handling Equipment .....	30
POLLUTION EQUIPMENT .....	30
Results of Technological Improvements .....	31
<b>CHAPTER III — TYPICAL CAST IRON SOIL PIPE LAYOUTS .....</b>	<b>32</b>
STORM DRAINAGE .....	32
Building Sub-drains and Sub-soil Drains .....	32
Roof Drains .....	32
THE USE OF TRAPS .....	36
VENTING AND DRAINAGE SYSTEMS .....	36

TABLE OF CONTENTS

	Page
<b>CHAPTER IV — INSTALLATION OF CAST IRON SOIL PIPE AND FITTINGS</b> .....	44
HANDLING .....	44
METHODS OF CUTTING CAST IRON SOIL PIPE .....	44
JOINING METHODS FOR CAST IRON SOIL PIPE .....	45
Compression Gaskets .....	45
Hubless Joints .....	47
Caulked Joints .....	47
UNDERGROUND INSTALLATION PROCEDURES .....	49
ABOVE GROUND INSTALLATION PROCEDURES .....	50
GENERAL INSTALLATION INSTRUCTIONS .....	50
Vertical Piping .....	50
Horizontal Piping, Suspended .....	50
Horizontal Piping, Underground .....	50
Installation Inside the Building .....	51
Horizontal Installation of Large Diameter Pipe .....	52
Suggested Installation of Horizontal Fittings .....	52
Vertical Piping .....	55
Seismic Restraints .....	56
TESTING AND INSPECTION .....	57
Air Test .....	57
Water Test .....	58
Smoke Test .....	59
Peppermint Test .....	59
Thrust Forces .....	60
PAINTING CAST IRON SOIL PIPE .....	60
THE SIZING OF SOIL, WASTE AND VENT LINES .....	60
INSTALLATION OUTSIDE THE BUILDING .....	61
Excavation and Preparation of the Trench .....	61
Line, Grade and Alignment of the House Sewer .....	61
Testing and Inspection of the House or Building Sewer .....	64
Placing the Backfill .....	64
Maintenance of the House Sewer .....	65
PROTECTING CAST IRON PIPE FROM CORROSIVE SOILS .....	66
Polyethylene Installation Procedures .....	66
Protection of Pipe .....	67
Protection of Fittings .....	68



TABLE OF CONTENTS

	Page
INFILTRATION AND EXFILTRATION .....	69
Infiltration .....	69
Exfiltration .....	70
<b>CHAPTER V — TRENCHING RECOMMENDATIONS FOR CAST IRON SOIL PIPE .....</b>	<b>71</b>
BURIAL OF CAST IRON SOIL PIPE AND FITTINGS .....	73
WHY SELECT CAST IRON FOR YOUR UNDERGROUND INSTALLATION? .....	80
<b>CHAPTER VI — UNDERGROUND INSTALLATION COMPARISON: FLEXIBLE VS RIGID .....</b>	<b>81</b>
UNDERGROUND SEWERS — ARE THEY INSPECTED CORRECTLY?.....	81
TRENCH WIDTH.....	82
TRENCH BOTTOM.....	82
COMPACTION OF BACKFILL .....	83
DEFLECTION .....	84
DETERMINATION OF EXPECTED LOADS AND CRUSH VALUES .....	85
<b>CHAPTER VII — RECOMMENDATIONS FOR DEEP BURIAL OF CAST IRON SOIL PIPE.....</b>	<b>88</b>
SUMMARY AND CONCLUSIONS .....	88
STRUCTURAL DESIGN OF BURIED CAST IRON SOIL PIPE .....	88
RING DESIGN.....	91
THREE EDGE BEARING FORMULA.....	91
DESIGN SUMMARY.....	95
PRESSURE CONCENTRATION FACTOR .....	96
VERTICAL SOIL PRESSURE .....	96
INSTALLATION EXAMPLE .....	97
BEAM STRESSES.....	97

	Page
<b>CHAPTER VIII — FLOW THEORY AND CAPACITY</b> .....	100
FLOW IN SEWERS AND DRAINS .....	100
LAMINAR FLOW AND TURBULENT FLOW .....	101
PREMISES GOVERNING FLOW DETERMINATION .....	101
FORMULAS FOR FLOW DETERMINATION .....	102
FLOW CAPACITY OF CAST IRON SOIL PIPE SEWERS AND DRAINS .....	104
DESIGN OF SEWERS AND DRAINS .....	115
EXAMPLE .....	115
<b>CHAPTER IX — WHY YOU NEED TO SPECIFY CAST IRON PLUMBING FOR YOUR HOME</b> .....	119
WHY CAST IRON .....	120
The Quiet Pipe® .....	120
Ease of Installation .....	120
Strength, Durability, and Safety .....	121
Environmentally Friendly .....	121
Cost Myths .....	121
Availability Myths .....	122
The Best Value .....	122
<b>CHAPTER X — ADVANTAGES OF SPECIFYING CAST IRON SOIL PIPE FOR A QUALITY PLUMBING SYSTEM</b> .....	123
CAST IRON – THE QUIET PIPE® .....	123
NOISE, ITS MEASUREMENT CONTROL .....	123
PIPE MATERIALS AND THE CONTROL OF PLUMBING NOISE .....	124
Test Methods .....	125
Test Results .....	126
The Role of Neoprene in Plumbing Noise Reduction .....	128
MJM ACOUSTICAL CONSULTANTS .....	129
CAST IRON – THE GREEN PIPE .....	131
What Makes a Building “Green”? .....	131
What Makes Cast Iron Soil Pipe “Green”? .....	132
The Green Building Council .....	132
Specifying The Green Pipe .....	133

TABLE OF CONTENTS

	Page
CAST IRON IN FIRE RESISTIVE CONSTRUCTION .....	134
Prevention of Fire Spread. ....	134
Combustible Piping Penetrations .....	134
Non-combustible Piping Penetrations .....	136
Piping Exposed in Plenums .....	136
WHY SPECIFY CAST IRON SOIL PIPE IN YOUR PROJECT .....	136
<b>CHAPTER XI — CAST IRON SOIL PIPE FOR CONDENSATE DRAIN LINES .....</b>	<b>137</b>
ASSEMBLY AND INSTALLATION OF MATERIALS TESTED FOR USE IN CONDENSATE DRAIN LINES .....	137
Assembly Procedures and Comparative Costs .....	138
DESCRIPTION OF TEST RIGS AND CHRONOLOGY OF TESTING PROCEDURES .....	139
Test Rigs .....	139
Testing Procedures .....	139
CONCLUSIONS AND RECOMMENDATIIONS .....	140
<b>CHAPTER XII — SUGGESTED SPECIFICATIONS FOR ENGINEERS, ARCHITECTS, AND PLUMBING DESIGNERS FOR SANITARY WASTE , VENT, SEWER AND STORM DRAINAGE SYSTEMS .....</b>	<b>141</b>
Below Grade .....	141
Above Grade .....	141
Joints .....	141
STANDARDS .....	142
Cast Iron Soil Pipe Institute Standard Specifications .....	142
ASTM Standard Specifications .....	142
FIRESTOPPING SPECIFICATION .....	143
<b>APPENDIX A — STRENGTH ANALYSIS OF THIN-WALLED SYMMETRICALLY LOADED RINGS .....</b>	<b>146</b>
HORIZONTAL SOIL SUPPORT .....	146
PIPE STIFFNESS .....	147
DESIGN SOIL PRESSURE .....	147
SAFETY FACTOR .....	147

TABLE OF CONTENTS

	Page
<b>APPENDIX B — TECHNIQUES FOR PLACEMENT OF SOIL AROUND BURIED CAST IRON SOIL PIPE .....</b>	150
Dumping and Shoving .....	151
Flushing .....	151
Vibrating .....	151
Mechanical Impact .....	151
<b>APPENDIX C — PRESSURE REDUCTION FACTOR K FOR COMPRESSIBLE SOIL ENVELOPE .....</b>	153
<b>APPENDIX D — ABBREVIATIONS, DEFINITIONS AND RECOMMENDED SYMBOLS FOR PLUMBING .....</b>	154
ABBREVIATIONS USED IN THE PLUMBING TRADES .....	154
DEFINITIONS USED IN THE PLUMBING TRADES .....	158
RECOMMENDED SYMBOLS FOR PLUMBING .....	164
<b>APPENDIX E — STATISTICAL TABLES AND CALCULATIONS .....</b>	169
<b>BIBLIOGRAPHY .....</b>	190
<b>INDEX .....</b>	193



# INTRODUCTION

The *Cast Iron Soil Pipe and Fittings Handbook* presents useful information of technical and general nature on the subject of cast iron soil pipe. In recent years, the volume and diversity of this information has increased, primarily as a result of changes in the industry and its products. Technological changes in foundry practice have been introduced; conventional products have been improved; and new products and new jointing methods have been developed, together with new installation procedures. Further, product standards and specifications have been revised. This handbook outlines these developments and provides useful information to professionals and laypeople alike.

## *The Cast Iron Soil Pipe Institute*

The publication of this handbook is consistent with the purposes and functions of the Cast Iron Soil Pipe Institute (CISPI), which was organized in 1949 by the leading American manufacturers of cast iron soil pipe and fittings. The Institute is dedicated to aiding and improving the plumbing industry. Through the preparation and distribution of technical reports, it seeks to advance interest in the manufacture, use, and distribution of cast iron soil pipe and fittings, and through a program of research and the cooperative effort of soil pipe manufacturers, it strives to improve the industry's products, achieve standardization of cast iron soil pipe and fittings, and provide a continuous program of product testing, evaluation, and development. Since the founding of the Institute, member firms have standardized soil pipe and fittings, and a number of new products have been introduced. Assurance that pipe and fittings meet the approved standards and tolerances of the Institute is provided by the ©®, or © NO-HUB® trademarks, which are the collective marks all member companies may place on their products.

The first edition of this handbook was compiled and edited by Frank T. Koelble, under the direction of William T. Hogan, S.J., of the Industrial Economics Research Institute, at Fordham University. Throughout its preparation, close contact was maintained with the Technical Committee of the Cast Iron Soil Pipe Institute for contributions of technical information on the manufacture and application of cast iron soil pipe and fittings. The original handbook contained copies of the industry's standard specifications for cast iron soil pipe, fittings, and accessories in addition to information on the history of the industry, the manufacture of its products, and their application. These specifications are now available under separate cover from CISPI.

*Recommendations for Deep Burial of Cast Iron Soil Pipe* were developed by the Institute's Technical Committee in 1983 under the guidance of Dr. Reynold King Watkins, Ph.D., Professor of Civil and Environmental Engineering at, Utah State University. These recommendations have been included in this edition as Chapter VII.

# CHAPTER I

## CAST IRON SOIL PIPE HISTORY, USES, AND PERFORMANCE

The origin of cast iron soil pipe manufacture in the United States and abroad is interwoven with historical developments in the production of cast iron pressure pipe. Prior to 1890, general information and statistical data on cast iron pipe did not distinguish between pressure pipe, which is used to transfer liquids under pressure, and soil pipe, which was developed to serve as a companion product for gravity-flow purposes.

### HISTORY OF CAST IRON SOIL PIPE

The early development of pipe systems was related to the growth of cities. As people began to concentrate within confined geographical areas, it became necessary to divert water from its natural course to provide for drinking, bathing, sanitation, and other needs. Ancient civilizations constructed aqueducts and tunnels, and manufactured pipe and tubing of clay, lead, bronze, and wood. All of these materials proved unsatisfactory because they were prone to deterioration and frequent breakdown. However, they filled a need and were used for hundreds of years until the introduction of cast iron as a pipe material.<sup>1</sup>

The earliest recorded use of cast iron pipe was at Langensalza, Germany, in about 1562, where it supplied water for a fountain. However, the first full-scale use of a cast iron pipe system for the distribution of water was installed in 1664 at the palace of Versailles in France. A cast iron main was constructed to carry water some 15 miles from Marly-on-Seine to the palace and surrounding area. The system is still functioning after more than 300 years of continual service. It represented a genuine pioneer effort because, at the time of installation, production costs on cast iron pipe were considered prohibitive. This was due principally to the fact that high-cost charcoal was used exclusively as a fuel to reduce iron ore until 1738, when it was replaced by coke in the reduction process. Immediately following this development, cast iron pipe was installed in a number of other distribution systems in France, and in 1746 it was introduced in London, England, by the Chelsea Water Company. In 1785 an engineer with this company, Sir Thomas Simpson, invented the bell and spigot joint, which has been used extensively ever since. It represented marked improvement over the earliest cast iron pipe, which used butt joints wrapped with metal bands, and a later version that used flanges, a lead gasket, and bolts.

<sup>1</sup> Historical information on cast iron soil pipe and fittings is contained in Noble, Henry Jeffers: "Development of Cast Iron Soil Pipe in Alabama," Supplement to *Pig Iron Rough Notes*, Birmingham, Sloss-Sheffield Steel and Iron Company, January 1941; U.S. Department of Interior, Census Office, *Manufacturing Census of 1890*, pp. 487 and 490; Cast Iron Pipe Research Association: *Handbook of Cast Iron Pipe*, Second Edition, Chicago, 1952, pp. 9–13; Clark, Victor S.: *History of Manufacturers in the United States*, Volume III 1893–1928, New York, McGraw-Hill Book Company, Inc., 1929, pp. 127–8; American Iron and Steel Association: *Directory to the Iron and Steel Works of the United States*, Philadelphia, 1898, pp. 74–5; The Engineer, Vol. XCI, London, January to June, 1901, pp. 157, 232, 358, 268, 313, 389, 443, 533—4, 587.

### *Early Production and Use in the United States*

Cast iron pipe was first used in the United States at the beginning of the nineteenth century. It was imported from England and Scotland to be installed in the water-supply and gas-lighting systems of the larger cities, principally those in the northeastern section of the country. One of the first cast iron pipe installations was at Bethlehem, Pennsylvania, where it was used to replace deteriorated wooden mains. As early as 1801, the City of Philadelphia sought to promote domestic manufacture of the product, but this campaign was not successful until 1819, when production was begun at a number of charcoal furnace plants in New Jersey. At about the same time, a foundry located at West Point, New York, also produced limited amounts of cast iron pipe.

The first manufacturer of cast iron pipe in the United States was located at Weymouth, New Jersey. Metal direct from the blast furnace was cast into 16-inch diameter pipe for the City of Philadelphia. And was used to replace the old pine-log pipe for the force main from the pumping station to the reservoir, although wooden pipe continued to be used for the distribution system. The iron was obtained by melting New Jersey bog ore, and the pipe was cast in molds laid horizontally in the casting beds used to cast pig iron. The small blast furnace was tapped, and the stream of molten metal filled one mold and was then diverted to another. Production at this foundry and at other foundries that began production of cast iron pipe in 1819 was strictly limited, and the industry was dormant until 1830, when a foundry designed specifically for cast iron pipe production was constructed at Millville, New Jersey. The foundry used the same ore and the same casting process as at Weymouth, but it produced cast iron pipe on a regular basis and had a capacity of 18,000 tons of pipe per year. The company at Millville had been in existence since 1803.

Prior to the early 1850s, horizontal green-sand molds and dry-sand or loam cores were used exclusively to produce cast iron pipe. By 1854 the "cast-on-end-in-pit" principle of pipe manufacture using dry-sand molds and dry-sand cores gained wide acceptance for the production of pressure pipe. It was introduced by George Peacock, who also is credited with inventing the drop pattern used in machine molding and the application of core arbors to the green-sand molding of fittings. Vertical casting was used to produce pressure pipe in 12-foot lengths, while horizontal molds continued to be used for shorter lengths of pressure pipe. A green-sand core was developed for use with the horizontal mold, and this was the first method employed to manufacture cast iron soil pipe.

As the demand for cast iron pipe increased, eastern Pennsylvania and the adjoining sections of New Jersey developed as the earliest sites of the industry, with the largest works located in the immediate vicinity of Philadelphia. The plants in eastern Pennsylvania used anthracite coal to reduce iron ore, and after 1861, when coke made from bituminous coal was widely adopted, cast iron pipe manufacture was started in western Pennsylvania and Ohio.

### *Growth and Dispersion of Foundries, 1880–1890*

Prior to 1880, the foundries of New Jersey and Pennsylvania supplied the great majority of the nation's cast iron pipe requirements, but during the 1880s production spread to the South and the Midwest. The advance in municipal improvements in these areas and the dispersion of the pig iron industry encouraged the location of plants closer to new markets and at points where pig iron and fuel costs were low. The largest number of cast iron pipe foundries built during the 1880s were located in the southern and midwestern sections of the country. Most of these were of comparatively large capacity, so that by 1890, the share of total output by the foundries of New Jersey and Pennsylvania had declined to 43 percent.

During the census year 1890, there were 33 establishments in the United States engaged principally in the manufacture of cast iron pipe. The rapid growth of the industry between 1880 and 1890 was indicated by the large number of foundries constructed during the period. Table 1 presents



a statistical summary of the cast iron pipe industry in 1890. The data presented by the Census Office was the first statistical tabulation of cast iron pipe works separate from the operations of general foundries that had ever been published. It was not indicated just how much of total cast iron pipe production was pressure pipe and how much was soil pipe, and the foundry breakdown does not reflect the construction of a number of plants undertaken during 1890.

**TABLE 1**  
*Cast Iron Pipe Industry, by States: 1890*

States	Number of Establishments <sup>3</sup>	Capital	Employees	Pipe Production	
				Tons <sup>4</sup>	Value
New York	3	\$ 589,463	337	13,066	\$ 412,382
Massachusetts					
New Jersey	6	4,543,204	2,284	185,510	4,800,590
Pennsylvania	6	1,320,407	709	48,860	1,225,440
Southern States <sup>1</sup>	8	3,561,162	1,964	128,253	3,178,175
Ohio	4	1,950,311	1,067	73,734	1,829,680
Other Western States <sup>2</sup>	6	2,215,186	1,218	63,827	1,644,942
<b>Total U.S.</b>	<b>33</b>	<b>\$14,179,733</b>	<b>7,579</b>	<b>513,250</b>	<b>\$13,091,209</b>

Source: U.S. Department of the Interior, Census Office, *Manufacturing Census of 1890*, pp. 487 and 490.

<sup>1</sup> Includes establishments located as follows: Alabama 1, Kentucky 2, Tennessee 2, Texas 1, Virginia 2.

<sup>2</sup> Includes establishments located as follows: Colorado 1, Michigan 1, Missouri 2, Oregon 1, Wisconsin 1.

<sup>3</sup> Does not include two idle establishments located in Pennsylvania.

<sup>4</sup> Short tons.

Nearly all of the establishments producing cast iron pipe in 1890 were engaged in its manufacture as a sole specialty. Foundries devoted to general work produced a small amount of pipe, but this was primarily for the local trade or for use in specific applications. The demand for standard sizes of pipe necessitated its production on a large scale in foundries designed and equipped specifically for this type of work. A number of pipe manufacturers also produced hydrants, fittings, and connections, and a few made hydraulic and gas machinery, machine shop equipment, and general foundry products. However, this non-pipe production activity constituted only a small part of the total business of these establishments. Most of the foundries used pig iron exclusively to manufacture pipe, but a few used small quantities of scrap iron.

During the 1880s a number of municipal codes were instituted dealing with the use of pipe in building construction, and both pressure pipe and soil pipe were manufactured to meet the specifications of these codes. One of the first plumbing codes was published in 1881 in Washington, D.C., and contains the following references to soil pipe installations and specifications:

Sec. 17. When necessary to lay a soil pipe under a building, such pipe shall be of iron with leaded joints, and shall be so located as to be accessible for inspection. Such pipes shall be kept above ground if practicable, shall not be less than 4" in diameter, and shall extend above the roof of the house; this extension shall be at least 4" in diameter.

Sec. 19. The weight of all iron pipe used underground shall not be less than —  
For 6" pipe, 20 lbs. per linear foot  
For 5" pipe, 17 lbs. per linear foot

For 4" pipe, 13 lbs. per linear foot  
For 3" pipe, 9½ lbs. per linear foot  
For 2" pipe, 5½ lbs. per linear foot

Sec. 20. All iron soil and sewer pipes shall be coated inside and outside with coal tar applied hot. All changes in direction shall be made with curved pipes, and all connections with Y branches and ¼ bends.<sup>2</sup>

An important development in soil pipe manufacture occurred in the late 1880s, when John Foran introduced a machine that made possible the economical production of green-sand cores. Prior to this time, green-sand cores were made either by ramming the core material into a core box or by using tempered sand packed on a core arbor by hand or dropped through a sieve on a revolving core barrel. The on-side method of soil pipe manufacture with green-sand molds and green-sand cores remained in exclusive use until the advent of centrifugal casting for soil pipe production.

### *Emergence of the Cast Iron Soil Pipe Industry*

The 1890s marked the emergence of cast iron soil pipe manufacture as a distinct industrial activity. Cities continued to install waterworks and sewage systems at a rapid pace, and the total number of cast iron pipe foundries in the United States increased to 64 in 1894 and 71 in 1898, divided equally between pressure pipe and soil pipe foundries, and by 1898 there were 37 foundries devoted to soil pipe production located in 13 states, with an annual melting capacity of approximately 560,000 net tons. New York, with seven foundries, was foremost among the states in soil pipe production. There were four foundries each in Alabama, New Jersey, Pennsylvania, and Illinois; three foundries each in Maryland and Wisconsin, two foundries each in Ohio and Indiana; and one foundry each located in Delaware, Kentucky, Missouri, and Tennessee. Consequently, by the turn of the century the cast iron soil pipe industry had penetrated the Northeast, the South, and the Midwest.

In 1899 the Central Foundry Company, with a capital stock of \$14 million, was incorporated as a consolidation of 34 of the nation's principal cast iron soil pipe manufacturers. It operated as one concern, and some of the individual plants absorbed by the company were closed. In 1900 the company operated 14 soil pipe foundries in different parts of the country with an aggregate daily capacity of about 500 tons of finished product. By 1903 additional operations had been combined, and the number of foundries operated by the company was reduced to nine. There were three plants in Alabama at Anniston, Bessemer and Gadsden, and one plant each at Baltimore, Maryland; Medina, New York; Newark, New Jersey; Lansdale, Pennsylvania; South Pittsburgh, Tennessee; and Vincennes, Indiana.

After 1900, Alabama quickly moved to the lead among cast iron soil pipe producing sales. Alabama was the third-largest pig iron producer in the nation due principally to its deposits of iron ore, coal, and limestone. The manufacture of pressure pipe had become a factor in the iron industry in Alabama prior to 1890, and soil pipe production was started there between 1888 and 1893. The state offered the advantages of excellent foundry irons and low production costs, which served to attract investment capital, and eventually the hub of the soil pipe industry was shifted from the Northeast to the South. By 1915 soil pipe foundries had been constructed in this state at Birmingham, Bessemer, Pell City, Gadsden, Anniston, Holt, Attalla and Talladega, and they met about 35 percent of the nation's soil pipe requirements.

<sup>2</sup> Noble, "Development Iron Soil Pipe in Alabama," p. 10.

The production of cast iron soil pipe and fittings in the United States, which reached a peak level of 280,000 net tons in 1916, decreased during World War I and totaled only 111,000 net tons in 1918. Following the war, building projects which had been deferred were undertaken, and as construction activity increased so did the demand for building materials, including soil pipe. During the early 1920s the industry invested heavily in new plants and equipment. In Anniston, Alabama, five new foundries were constructed during this period, which raised the city's annual output to 140,000 net tons and made it the largest production center for cast iron soil pipe in the world. By 1922 the nation's production of cast iron soil pipe and fittings had reached 357,000 net tons, and approximately 180,000 net tons, or 50 percent, were produced in Alabama.

## **USES OF CAST IRON SOIL PIPE**

Cast iron soil pipe and fittings are used primarily in building construction for sanitary and storm drain, waste, and vent piping applications. The product is installed in residential construction, hospitals, schools, and in commercial and industrial structures. For this reason, the pattern of cast iron soil pipe shipments and sales is directly related to the pattern of building/construction activity.

In buildings, the principal assembly of this piping is installed within the partitions and serves the tub, lavatory, and water closet fixtures. The main line in this assembly is the cast iron soil stack, which runs vertically from the building drain up through the structure and through the roof. Waste lines are connected to this main soil stack, and vent lines may also be tied in at a point above the highest fixture. In some installations vent lines are connected to a separate vent stack, which acts as the main source of air to and from the roof.

The building or house drain, the lowest horizontal piping in the drainage system, receives the discharge from the soil, waste, and drainage pipes from within the building and conveys the discharge to the building sewer. The building or house sewer, in turn, conveys the discharge away from the structure, to the point prescribed by the local plumbing code for joining to the city sewer, septic tank, or other means of disposal.

An additional use for cast iron soil pipe and fittings in building construction is for storm drainage from roofs, yards, areaways, and courts. It is used for collecting subsoil drains, which are placed around the structure's foundation for connection into a storm drainage system or into a sump. It is also used for roof leaders, particularly when these are placed within the building, pipe space, or other area. Extensive use is made of soil pipe for storm drainage on high-rise buildings, where large setbacks accumulate substantial amounts of rainwater and snow. At present, cast iron soil pipe is used in high-rise building construction for drain, waste, vent, and sewer purposes without concern for building height and is, in fact, the preferred material.

## **REQUIREMENTS FOR A SAFE AND DURABLE DRAIN, WASTE, AND VENT SYSTEM**

The satisfactory performance of a piping system used for drain, waste, vent, and sewer plumbing applications in a given structure requires that the material possess the following important characteristics:

- Durability exceeding expected life of the building
- Resistance to corrosion
- Noncombustibility and does not spread flame
- Resistance to abrasion
- Ability to withstand temperature extremes

- Ability to withstand traffic and trench loads
- Low coefficient of expansion/contraction
- Joints that resist infiltration and exfiltration
- Strength and rigidity
- Resistance to noise transmission

### ***Cast Iron Soil Pipe and Fittings Meet or Exceed All These Requirements***

Tests of cast iron soil pipe for these properties reveal its superior characteristics as a material for all drain, waste, vent, and sewer piping.

### ***Corrosion Resistance***

Cast iron has, for hundreds of years, been the preferred piping material throughout the world for drain, waste, and vent plumbing applications and water distribution. Gray iron can be cast into pipe at low cost and has excellent strength properties. Unique corrosion resistance characteristics make cast iron soil pipe ideally suited for plumbing applications.

Cast iron and steel corrode; however, because of the free graphite content of cast iron (3 – 4 percent by weight or about 10 percent by volume), an insoluble graphitic layer of corrosion products is left behind in the process of corrosion. These corrosion products are very dense, adherent, have considerable strength, and form a barrier against further corrosion. Because of the absence of free graphite in steel, the corrosion products have little or no strength or adherence and flake off as they are formed, thus presenting fresh surfaces for further corrosion. In tests of severely corroded cast iron pipe, the graphitic corrosion products have withstood pressures of several hundred pounds per square inch although corrosion had actually penetrated the pipe wall.

The majority of soils throughout the world are non-corrosive to cast iron. More than 535 water and gas utilities in the United States have cast iron distribution mains with continuous service records of more than 100 years. Fifty-three have mains more than 150 years old. Over 95 percent of all cast iron pipe that has ever been installed in underground service in the United States is still in use.

The corrosion of metals underground is an electrochemical phenomenon that can take place in two ways: galvanic corrosion or electrolytic corrosion.

Galvanic corrosion is self-generating and occurs on the surface of a metal exposed to an electrolyte (such as moist, salt-laden soil). The action is similar to what occurs in a wet-cell or dry-cell battery. Differences in electrical potential between locations on the surface of the metal (pipe) in contact with such soil may occur for a variety of reasons, including the joining of different metals (iron and copper or brass, for example). Differences in potential may also be caused by the characteristics of the soil in contact with the pipe surface, such as, pH, soluble salt, oxygen and moisture content, soil resistivity, temperature and presence of certain bacteria. Any one or a combination of these factors may cause a small amount of electrical current to flow through the soil between areas on the pipe or metal surface. Where this current discharges into the soil from such an area, metal is removed from the pipe surface and corrosion occurs.

Electrolytic corrosion occurs when direct current from outside sources enters and then leaves an underground metal surface to return to its source through the soil; metal is removed and in this process corrosion occurs.

Over 95 percent of the soils in the United States are non-corrosive to cast iron. Those few soils that are somewhat corrosive to cast iron include natural soils containing high concentrations of decomposing organic matter (swamps, peat bogs, etc.) alkalis, or salt (tidal marshes). Man-made corrosive soils result from the discharge of various mining and other industrial and municipal wastes into refuse dumps or landfills.

The National Bureau of Standards and the Cast Iron Pipe Research Association (now known as the Ductile Iron Pipe Research Association, DIPRA) have studied underground corrosion of cast iron pipe for many years. As a result of these studies, a procedure has been developed for determining the need for any special corrosion protection: a simple and inexpensive method of providing such protection using a loose wrap of polyethylene film. The information contained in American National Standard A21.5, American Society of Testing and Materials A674, A74 and A888, and American Water Works Association Specification C 105 provide installation instructions and an appendix that details a 10-point scale to determine whether the soils are potentially corrosive to cast iron. Information on these Standards is available from the Cast Iron Soil Pipe Institute and its member companies.

Because the 300 series of nickel-chromium stainless steel is even more resistant to corrosion than cast iron, the stainless steel housings on No-Hub couplings used to join hubless cast iron soil pipe and fittings require no more special protection against corrosion than the pipe itself. Roughly 1½ billion No-Hub couplings installed since 1961 in North America attest to the durability of these couplings.

Internal corrosion of cast iron soil pipe and fittings can be caused by strong acids or other aggressive reagents with a pH of 4.3 or lower if allowed to remain in contact cast iron pipe for an extended period of time. If the run of piping into which the acidic waste is discharged has sufficient upstream flow of non-acidic waste, the resulting rinsing action tends to raise the pH of the combined waste to a level that will not corrode cast iron. However, by avoiding low pH discharges altogether, one can limit or eliminate internal corrosion problems, assuring the building owner and occupants many years of trouble-free service.

### ***Expansive Soils***

Some dense clay soils expand and shrink when subjected to wetting and drying conditions. In dry periods cracks form, and when wet conditions return, the soil absorbs moisture and expands. If this condition is present it is recommended that the trench be excavated to greater-than-normal depth and select backfill materials be used to provide protection from this movement.

### ***Resistance to Abrasion***

Cast iron soil pipe is highly resistant to abrasion from sand, gravel, glass particles, garbage disposal residue, dishwasher discharge, and debris being carried in suspension, both at low and high velocities, or washed along the lower portion of the sewer or drain. This characteristic has been very well documented by examinations of existing soil pipe.

## **CAST IRON SOIL PIPE JOINTS AND THEIR CHARACTERISTICS**

The cast iron soil pipe gasketed joints shown in Figure 1 are semi-rigid, watertight connections of two or more pieces of pipe or fittings in a sanitary waste, vent, or sewer system. These joints are

designed to give rigidity under normal conditions and still permit sufficient flexibility under adverse conditions, such as ground shift, footing settlement, wall creepage, building sway, etc., to allow pipe movement without breakage or joint leakage. Properly installed, the joints have equal longevity with the cast iron soil pipe and can be installed in walls, underground, and in other inaccessible locations.

### ***Types of Cast Iron Soil Pipe and Fittings***

Cast Iron Soil Pipe used in the United States is classified into two major types—hub and spigot and hubless. Hubless pipe and fittings are also referred to in the plumbing industry as no-hub. The Cast Iron Soil Pipe Institute maintains a trademark on the term CI no-hub® which it licenses its members to use on hubless pipe and fittings. The terms hubless, no-hub, and CI no-hub® are used interchangeably in this text and throughout the industry.

Hubless cast iron soil pipe and fittings are simply pipe and fittings manufactured without a hub, in accordance with ASTM A888 or CISPI 301. The method of joining the pipe and fittings utilizes a hubless coupling that slips over the plain ends of the pipe and fittings and is tightened to seal the joint. Hubless cast iron soil pipe and fittings are made in only one class or thickness. There are many varied configurations of fittings, and both pipe and fittings range in sizes from 1½" to 15". Couplings for use in joining hubless pipe and fittings are also available in these size ranges from the member companies of the Cast Iron Soil Pipe Institute.

Hub and Spigot pipe and fittings have hubs into which the spigot (plain end) of the pipe or fitting is inserted. The joint is sealed with a rubber compression gasket or molten lead and oakum. Hub and Spigot pipe and fittings are available in two classes or thicknesses, classified as Service (SV) and Extra Heavy (XH). Because the additional wall thickness is added to the outside diameter, Service (SV) and Extra Heavy (XH) have different outside diameters and are not readily interchangeable. These two different types of pipe and fittings can be connected with adaptors available from the manufacturer. Hub and Spigot pipe and fittings are made in accordance with ASTM A-74 and are available in 2"–15" sizes. Compression gaskets, lubricant, and assembly tools are available from the member companies of the Cast Iron Soil Pipe Institute.

### ***Shielded No-Hub Coupling***

The shielded no-hub coupling for cast iron soil pipe and fittings is a plumbing concept that provides a more compact arrangement without sacrificing the quality and permanence of cast iron. The design, depicted in Figure 1 (a), typically uses a one-piece neoprene gasket with a shield and stainless steel retaining clamps. The great advantage of the system is that it permits joints to be made in limited-access areas.

The 300 series stainless steel often used with no-hub couplings was selected because of its superior corrosion resistance. It is resistant to oxidation, warping, and deformation; offers rigidity under tension with a substantial tensile strength; and yet provides sufficient flexibility.

The shield is corrugated in order to grip the gasket sleeve and give maximum compression distribution. The stainless steel worm gear clamps compress the neoprene gasket to seal the joint. The gasket absorbs shock and vibration, and completely eliminates galvanic action between the cast iron soil pipe and the stainless steel shield.

### *The Compression Joint*

The compression joint is the result of research and development to provide an efficient, lower-cost method for joining cast iron soil pipe and fittings. The joint is not unique in application to cast iron soil pipe, since similar compression-type gaskets have been used successfully in pressure pipe joints for years. As shown in Figure 1 (b), the compression joint uses hub and spigot pipe, as does the lead and oakum joint. The major difference is the one-piece rubber gasket.

When the spigot end of the pipe or fitting is pushed or drawn into the gasketed hub, the joint is sealed by displacement and compression of the rubber gasket. The resulting joint is leak-proof and root-proof. It absorbs vibration and can be deflected up to 5 degrees without leakage or failure.

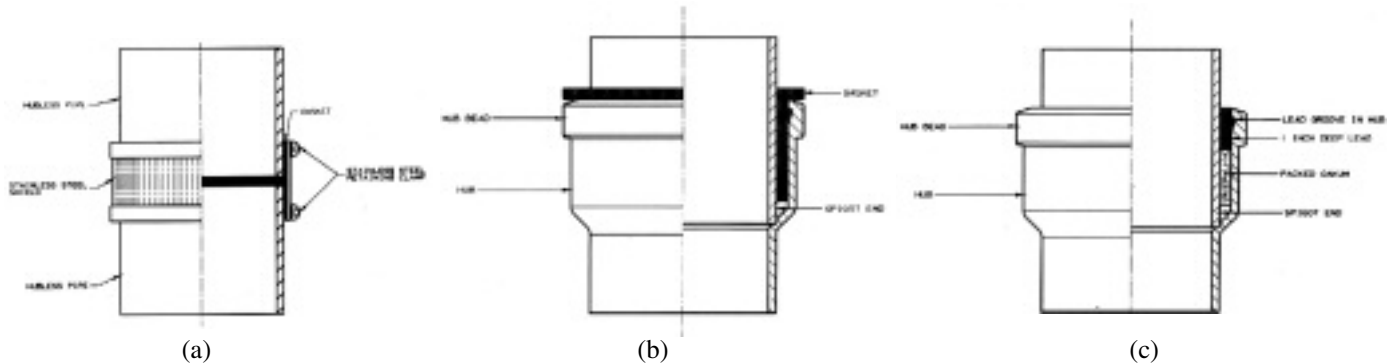

Figure 1—Typical Joints Used to Connect Cast Iron Soil Pipe and Fittings: (a) Typical Hubless Coupling; (b) Compression Joint; (c) Lead and Oakum Joint.

### *The Lead And Oakum Joint*

Cast iron soil pipe joints made with oakum fiber and molten lead are leak-proof, strong, flexible, and root-proof. The waterproofing characteristics of oakum fiber have long been recognized by the plumbing trades, and when molten lead is poured over the oakum in a cast iron soil pipe joint, it completely seals and locks the joint. This is due to the fact that the hot metal fills a groove in the bell end of the pipe, firmly anchoring the lead in place after cooling. When the lead has cooled sufficiently, it is caulked into the joint with a caulking tool to form a solid metal insert. The result is a lock-tight soil pipe joint with excellent flexural characteristics.

### *Soundproofing Qualities of Cast Iron With Rubber Gasket Joints*

One of the most significant features of the compression gasketed joint and hubless coupling is that they assure a quieter plumbing drainage system. The problem of noise is particularly acute in multiple dwelling units. Although soundproofing has become a major concern in construction design, certain plumbing products have been introduced that not only transmit noise but in some cases actually amplify it. The use of neoprene gaskets and cast iron soil pipe reduces noise and vibration to an absolute minimum. Because of the density and wall thickness of the pipe, sound is muffled rather than transmitted or amplified, and the neoprene gaskets separate the lengths of pipe and the units of fittings so that they suppress any contact-related sound. The result is that objectionable plumbing noises are minimized.

A detailed discussion of the soundproofing qualities of cast iron soil pipe DWV systems is contained in Chapter X.

## **ECONOMIC ADVANTAGES OF CAST IRON SOIL PIPE**

The foregoing sections of this chapter, which discuss the uses of cast iron soil pipe, its properties, and the various joining systems, demonstrate that cast iron soil pipe affords a number of economic advantages. These advantages include performance, versatility, low-cost installation and product availability.

### ***Performance***

The performance and durability of cast iron soil pipe are superior to any other product used for sanitary and storm drain, waste, and vent piping. These facts are supported by the data presented previously in this chapter and have a direct bearing on product selection. The choice is clear because service to the customer requires that performance constitutes the principal reason for material selection, and in the matter of performance cast iron soil pipe has no equal.

### ***Versatility***

Cast iron soil pipe is the most versatile sanitary and storm drain, waste, and vent piping material on the market. It is available with a variety of joining methods so that it can be installed efficiently throughout the plumbing drainage system, both above and below floors and beneath the ground. It is adaptable for use in all types of building construction, including one-family homes, multiple dwelling units or apartment buildings, high-rise structures such as hotels and office buildings, and many commercial industrial applications. The lead and oakum, compression gasket, and hubless couplings can be used either individually or in combination in a given plumbing system in order to meet the needs of any specific condition. All three joining methods are available in a variety of pipe lengths and with a complete line of cast iron soil pipe fittings.

### ***Low-Cost Installation***

Cast iron soil pipe offers the advantage of low-cost installation as a result of the speed and efficiency with which the hubless couplings and compression gasket joints can be made, and the with use of 10-foot pipe lengths, which reduces the required number of joints in a given plumbing system. Further, cast iron soil pipe can be preassembled before it is placed in the ground or wall. This eliminates the need to work in cramped quarters or muddy trenches and so speeds installation.

### ***Product Availability***

Cast iron soil pipe foundries are strategically located in various sections of the country so that orders can be filled on very short notice. In many areas it is possible to place an order and have it delivered overnight, ready for use the following day. Contractors need not be concerned about supply shortages, since the industry's manufacturing capacity is adequate and because the basic raw materials for the manufacture of soil pipe are abundant and readily obtainable from domestic sources.



# CHAPTER II

## THE MANUFACTURE OF CAST IRON SOIL PIPE AND FITTINGS

### THE CAST IRON SOIL PIPE INDUSTRY

#### *Manufacturers of Cast Iron Soil Pipe and Fittings*

AB & I  
7825 San Leandro Street  
Oakland, California 94621

Charlotte Pipe & Foundry Company  
P.O. Box 35430  
Charlotte, North Carolina 28235

Tyler Pipe Company  
Sales Office and Manufacturing Plant  
P.O. Box 2027, Tyler, Texas 75710  
Northeast Manufacturing Plant  
North Church Street  
Macungie, Pennsylvania 18062

### PRODUCTION OF CAST IRON SOIL PIPE AND FITTINGS IN THE UNITED STATES

Shipments of cast iron soil pipe and fittings have followed the path of the Nation's economy, lower in recession years and higher in the more prosperous years. An all-time high in tonnage shipments occurred in 1972, according to figures compiled by the U.S. Department of Commerce.

Of the total tonnage of cast iron soil pipe and fittings production, it is estimated that fittings constitute 22 to 25 percent. Pipe sizes are divided as follows: approximately 59 percent is 3-inch and 4-inch, 25 percent is 1½-inch and 2-inch and 16 percent is 5-inch and over.

Tonnage has dropped since 1972; however, the tonnage of cast iron soil pipe and fittings produced does not indicate that the demand for soil pipe and fittings is declining. The demand for cast iron soil pipe and fittings is strong and will be for many years to come.

Tonnage of cast iron soil pipe changed drastically when centrifugal pipe casting machines made their appearance. These machines produced more uniform wall thicknesses, which created a greater acceptance of service-weight soil pipe. As a result, the demand for extra heavy pipe and fittings decreased year after year to a point where it now constitutes less than 3 percent of the cast iron soil pipe produced.

The introduction of **☛** NO-HUB® soil pipe and fittings also reduced the total tonnage. The iron required to produce hubs was eliminated, but the compactness of the fittings also reduced the consumption of iron. The overall acceptance and demand for **☛** NO-HUB® in every state has had an effect on the tonnage produced annually.

Cast iron soil pipe fittings are castings of various shapes and sizes used in conjunction with cast iron soil pipe in the sanitary and storm drain, waste, and vent piping of buildings. These fittings include various designs and sizes, consisting of bends, tees, wyes, traps, drains, and other common or special fittings, with or without side inlets. The large variety of cast iron soil pipe fittings required in the United States is attributable to the many types and sizes of buildings and to the variety of requirements of various city, state, and regional plumbing codes. There are many plumbing codes in the United States, and often special cast iron soil pipe fittings are specified by individual codes. As a result, foundries in the industry make a large variety of special fittings to meet the requirements of their customers.

## **DISTRIBUTION OF CAST IRON SOIL PIPE AND FITTINGS**

Efficient distribution networks and large inventories provide ready availability of cast iron soil pipe and fittings. The foundries, working cooperatively with wholesalers and plumbing contractors, will fill an order and deliver it directly to the job site so that it does not have to be unloaded and reloaded at a supply house. This is of particular assistance to plumbing contractors working on large buildings. Nearly all of the industry's production is delivered by truck throughout the continental United States. Deliveries may be made on 24- to 48-hour notice from inventories. Sales are made through plumbing wholesalers.

## **NUMBER OF OPERATING UNITS**

Technological improvements in the manufacture of cast iron soil pipe and fittings have brought about a reduction in the number of operating plants, even though industry output has been increasing. In December of 1953 there were 56 plants reporting shipments to the U.S. Bureau of the Census. This number declined to 47 in 1956, to 38 in 1959, to 31 in 1967, and by 1980, according to the *Census*, there were 15 operating plants in the industry. Thus, although industry shipments increased by 53.9 percent between 1953 and 1972, the number of plants declined by 62.5 percent over the same period. It is important to note that despite the reduction in operating units, total capacity in the industry has remained fairly constant. EPA rules and OSHA regulations created overwhelming costs that a great many small producers could not endure. Modern, efficient mechanized manufacturing methods allowed current producers to increase overall production capacity.

## **THE MANUFACTURE OF CAST IRON SOIL PIPE AND FITTINGS**

### ***Types of Iron***

Soil pipe and fittings are manufactured of cast iron. Cast iron is a generic term for a series of alloys primarily of iron, carbon, and silicon. Cast iron also contains small amounts of other elements such as manganese, sulfur, and phosphorous. The chemical composition of the iron is determined by regularly scheduled analysis of samples taken from test blocks or test specimens, or directly from castings. Product standards require chemical and tensile testing to be performed a minimum of once every four hours during the course of production. The hardness of the iron is determined by its chemical composition and by the rate that the casting is cooled.

All CISPI member foundries utilize post-consumer recycled scrap iron and steel in the production of cast iron soil pipe and fittings. Recycling, through environmentally friendly, exposes the manufacturing foundry to an additional hazard: radiation from contaminated recycled materials. The use of scrap iron and steel in the production process necessitated the introduction of radiation screening equipment for all scrap iron and steel used in the production process. (See Figure 1.)

### ***The Modern Cast Iron Soil Pipe and Fittings Foundry***

The design and layout of the modern cast iron soil pipe and fittings foundry is planned so that there can be a smooth and efficient flow of production from raw materials to finished product. Typically, the foundry consists of six major sections or departments: 1) radiation screening; 2) the storage yard for raw materials; 3) the melting area; 4) the molding and casting area where the pipe and fittings are



Figure 1—Radiation Detector Screening Ferrous New Material for Radiation.

manufactured; 5) the cleaning department where the pipe and fittings are cleaned, coated and prepared for storage or shipment; and 6) the storage and shipping area for finished products.

Adjacent is an area for mold preparation, and a core room is provided to house coremaking machinery. The cleaning department contains abrasive shot-blast machinery and chipping and grinding equipment to remove sand, fins, gates, and risers from the pipe and fittings. Coating equipment is located in or adjacent to this section. The modern soil pipe foundry also includes a pattern shop and pattern storage room, a testing laboratory, a storage area for finished product inventories, and a packing and shipping section.

### ***Raw Materials and Melting Devices***

The cupola furnace is used as the principal method for obtaining the molten metal required for production. Electric melting equipment, such as coreless induction furnaces, may also be used. Regardless of the type of melting equipment employed, the make-up of the furnace charge determines the composition of the molten iron.

The basic raw materials used to produce cast iron soil pipe and fittings are scrap iron, steel scrap, alloys, coke, and limestone. These materials are stockpiled in the raw materials storage yard. The ratio between scrap iron and steel scrap for a given charge can vary over a wide range, depending on the relative availability of these materials. Silicon and carbon may be added to the molten iron in predetermined amounts to provide the proper final chemical composition.

An overhead bridge crane is used to handle these materials for charging into the melting furnace, which is normally located in close proximity to the raw materials storage yard. (See Figure 2.)

***The Cupola Furnace for Melting Iron:*** Melting of the raw materials to produce molten iron is usually accomplished in the cupola. The cupola is a vertically erected cylindrical shell of steel that can be either refractory lined or water cooled. (See Figure 3.) Cupolas are classified by shell diameter, which can range from 32" up to 150". A typical cupola consists of three main sections: the well, the melting zone, and the upper stack. The refractory lined well section includes the bottom doors



Figure 2—The Raw Materials Storage Yard of the Foundry.

that are hinged to the shell, the sand bottom, and the taphole. The bottom doors permit the removal of the sand bottom and the remaining material from the cupola after the last charge has been melted. The taphole is connected to a refractory lined slag separator, that is in turn attached to the outside of the shell. The melting zone features the tuyeres, which introduce the combustion air into the cupola from the wind box that surrounds the shell. The upper stack extends from the melting zone toward the charging door and may extend as much as 36 ft. above tuyere level. The upper stack is connected to the air pollution control equipment, which modern cupolas are required to have in order to eliminate particulate matter discharge into the atmosphere. (See Figure 4.)

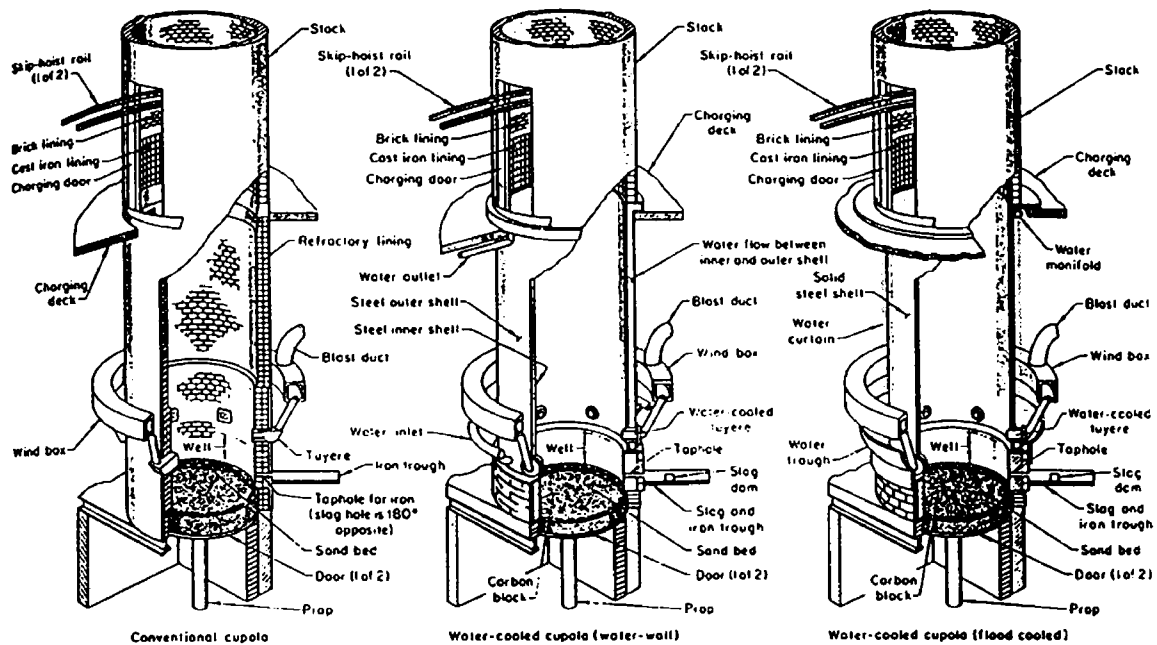

Figure 3—Sectional Views of Conventional and Water-Cooled Cupolas. The Conventional Type Shown Is Refractory Lined. Water-Cooled Types Incorporate Either an Enclosed Jacket or an Open Cascade Flow.



Figure 4—Bag House (Pollution Control Equipment).

### *The Start of the Operation of the Cupola*

First, the bottom doors are closed and secured. A sand bottom, slanted toward the taphole, is then rammed in place. Directly on this sand bottom, a coke bed is charged to the desired height above the tuyeres. Once the coke bed is thoroughly ignited and incandescent, alternate layers of ferrous scrap, coke, and limestone are charged through the charge door into the cupola. Coke is used to provide the necessary source of heat for the melting process. Limestone is added to flux away coke ash and other impurities from the charge. A cupola charge usually consists of eight to ten parts of metal by weight to one part of coke. When the cupola is filled up to the charging door, combustion air is introduced through the tuyeres to start the melting process. The combustion or blast air may be pre-heated up to 1200°F to improve melting efficiencies.

As melting occurs, the charges start to descend and additional layers of scrap, coke, and limestone are charged alternately into the cupola so that it remains filled up to the charge door. At the conclusion of the operation, all the charge in the cupola is melted down. When the meltdown is complete, the remaining molten metal and slag are drained. The bottom doors are opened and the sand bottom, together with the material remaining in the cupola is dropped to the ground.

The rate of melting in the cupola is governed by the diameter of the melting zone and by the amount of blast air blown through the tuyeres. Cupola melting capacities may range from 10 to 100 tons per hour. The molten iron temperature at the taphole normally lies between 2700°F and 2900°F. The melting operation is usually continuous. The molten metal that is discharged through the taphole is either accumulated in a forehearth or holding furnace, or is taken directly to the pouring area in refractory lined ladles. (See Figures 5 and 6.) When holding furnaces are utilized, they serve as a buffer or an accumulator between the melting and the casting operations, allowing molten iron temperatures to be controlled.



Figure 5—Iron flowing from the Cupola Furnace to Two Holding Ladles.

Rigid control is maintained during the melting and pouring processes to assure the proper composition of the molten iron necessary to cast quality soil pipe and fittings. During the operation frequent metallurgical tests are taken to insure the required chemical and physical properties of the pipe and fittings produced.

### **CASTING OF SOIL PIPE AND FITTINGS**

The casting of soil pipe and fittings in foundries throughout the United States is highly mechanized and incorporates the latest advances in foundry technology. The centrifugal casting process is used to produce pipe, whereas static casting is used to produce fittings. Centrifugal casting and modern static casting provide rigid production control and yield high quality pipe and fittings of uniform dimensions cast to exacting specifications.



Figure 6—Mixing Ladle Located in Front of a Cupola.

### *Centrifugal Pipe Casting*

Centrifugal casting in horizontal molds is used to make long, concentric, hollow castings of uniform wall thickness. In the centrifugal pipe casting process, a sand-lined or water-cooled metal mold is rotated on a horizontal axis during the interval of time that it receives a pre-measured quantity of molten iron. The centrifugal force created by this rotation causes the liquid iron to spread uniformly onto the mold's inner surface, thereby forming upon solidification a cylindrical pipe conforming to the inside dimensions of the mold. (See Figure 7.) One type of centrifugal pipe casting machine is illustrated in Figure 8.



Figure 7—Iron being poured into spinning pipe mold.

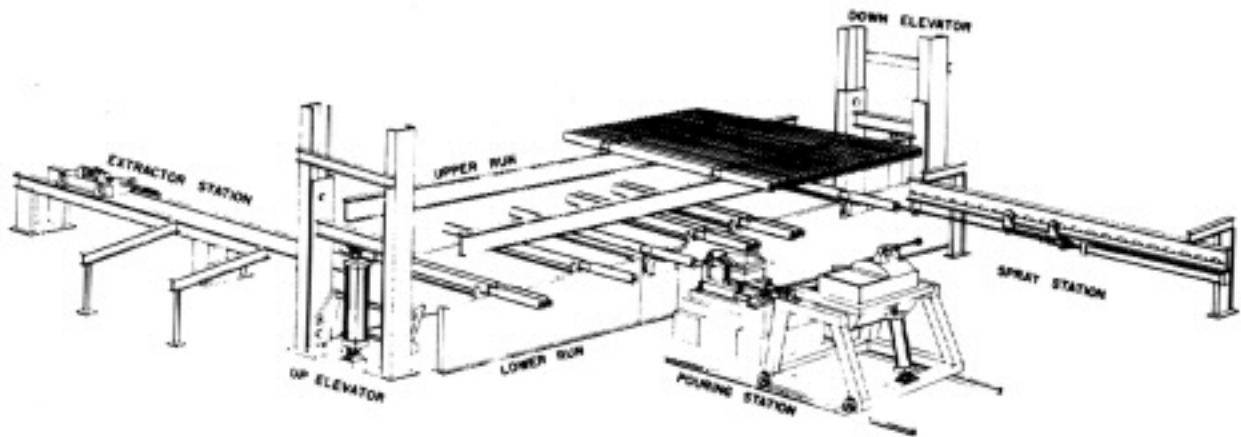

Figure 8—Illustration of a Centrifugal Pipe Casting Machine.

### *Sand-Lined Molds*

Sand-lined molds for a centrifugal pipe casting machine use foundry sand rammed into a cylindrical flask as it rotates in a horizontal position around a centered pipe pattern. One end of the flask is closed after the pattern has been inserted, and a mechanical sand slinger forces the sand through the opposite end and around the pattern with such velocity that a firm, rammed mold is

obtained. The pattern is then withdrawn. Cores (see description of coremaking) are then placed into the ends of the flask to contain the liquid metal, and the mold is then ready for the pouring operation.

Another method of making sand-lined molds consists of positioning a flask vertically on a revolving metal platen, which closes off its lower end. As the flask rotates, foundry sand drops into its open upper end. The flask, still spinning, then rotates to the horizontal and a mandrel is introduced and offset to form a cavity in the sand with the same contour as the outside of the pipe to be cast. Once this is accomplished, the mandrel shifts to the center of the mold and retracts. Next, cores are automatically set into the ends of the flask to complete preparation of the mold.

### ***Metal Molds***

Metal molds used in centrifugal pipe casting machines are spun on rollers and externally cooled by water. Prior to casting, the mold's inner surface may be coated with a thin refractory slurry as a deterrent to sticking.

### ***Casting Process***

Molten iron from the melting area is transferred to a pouring ladle, which is adjacent to the casting machine. The iron is weighed, taking into account the length and diameter of the pipe to be cast and its desired wall thickness. When the pouring ladle is tilted, the stream of molten iron enters a trough, which carries it into one end of the rotating pipe mold. Pouring continues until the supply of iron in the pouring ladle is exhausted. After the pipe is cast, it is allowed to solidify in the still rotating mold. Finally, the pipe is removed from the mold and is conveyed to the foundry's cleaning and finishing department.

## **STATIC CASTING OF FITTINGS**

Cast iron soil pipe fittings can be produced by two different static casting processes. One process casts fittings in sand molds, whereas the other uses permanent metal molds. Both processes use precision metal patterns and are highly mechanized to permit the volume production of fittings to close tolerances.

### ***Sand Casting***

Static sand casting uses sand cores surrounded by green-sand molds into which molten iron is poured to form castings. The sand is termed "green" because of its moisture content rather than its color. Sand that does not contain moisture is appropriately termed "dry" sand. The sand-casting process involves patternmaking, molding, coremaking, pouring, and shaking out.

***Patternmaking:*** A pattern is a form that conforms to the external shape of the fitting to be cast and around which molding material is packed to shape the casting cavity of the mold. It is made usually out of metal in a pattern shop by skilled craftsmen using precision machine tools and equipment. (See Figure 9.)





Figure 9—Operation of Precision Milling Machinery for Patternmaking.

**Molding:** Fitting molds are prepared by machine molding, either in flasks or by means of flaskless compression techniques. In both cases, the material used for molding is an aggregation of grains of sand mixed with small quantities of clay and other additives. It retains its shape when formed around a pattern and, given its refractory quality, can remain in contact with molten iron without the likelihood of fusion to the casting.

In molding machines using flasks, both the pattern and the flask are separated in two halves to facilitate removal of the pattern during the molding operation. The upper part of the flask is called the “cope,” and the lower part is called the “drag.” The pattern is used to form a cavity in the molding sand, which is rammed into both parts of the flask.

At the start of the molding operation, the lower half of the pattern is placed with the flat side down on the platen or table of a molding machine. The drag or lower half of the flask is then placed around it. The void between the pattern and the flask is filled with molding sand, which is rammed into a solid mass. When the flask and sand are lifted from the pattern, a molded cavity is obtained, corresponding to half of the outside surface of the fitting to be cast. The cope is formed in the same manner; when it is placed over the drag, the resultant cavity in the sand corresponds to the entire outside surface of the fitting. However, before pouring, a sand core must be inserted in the mold to keep the molten iron from completely filling the void. The core forms the fitting’s inner surface. Extensions on the pattern are provided to form “core prints” or depressions in the molding sand that will support the core at both ends. This prevents the core from dropping to the bottom of the sand cavity or from floating upward when the molten iron is poured into the mold. Figure 10 depicts fitting molds being made.

Some molding machines use mechanical jolting and/or squeezing to pack the sand about the pattern. The cope and the drag, both empty, are placed on alternate sides of a matchplate and surround the pattern, also mounted on the two sides. Molding sand is released from an overhead hopper into the drag, and the entire assembly is then jolted to distribute the sand evenly, after which the excess is scraped off. A bottom board is then placed on the drag, and the assembly is rotated 180 degrees to expose the cope. It is similarly filled with molding sand, and after this, a simultaneous squeezing of both the cope and the drag takes place. The cope is then lifted so that the operator can remove the pattern and insert a sand core.

The second method of fitting mold-preparation for sand casting, which uses flaskless compression molding machines, has greatly increased the speed and efficiency of the molding operation. Although molding time varies depending on the type and size of the fittings to be cast, it is not uncommon for flaskless molding to be several times faster than cope-and-drag flask molding.



Figure 10—Making a Fitting Mold.

In flaskless compression molding, two matched patterns, each conforming to half of the outside surface of the fitting to be cast, are used in a compression chamber to form flaskless sand molds. The patterns are mounted vertically inside the chamber, their flat sides fixed against two of the chamber's opposite ends, generally referred to as "pattern plates." Molding sand is fed into the chamber from an overhead bin and is squeezed between the patterns to form a mold with a pattern impression (one-half of a casting cavity) in each of its end surfaces. During the squeezing operation one of the pattern plates, also known as the "squeeze plate," moves inward to compress the molding sand. The other pattern plate remains stationary until the mold is formed and then releases, moving outward and upward, whereupon a core is automatically set in the exposed pattern impression. The squeeze plate then pushes the mold out of the compression chamber directly onto a "pouring rail" to close up with the previously prepared mold just ahead of it. In this manner, once a number of such close-up operations have occurred, a string of completed fitting molds ready for pouring is obtained, and it advances a short distance as each newly prepared mold arrives on the pouring rail. A string of flaskless fitting molds is illustrated in Figure 11.

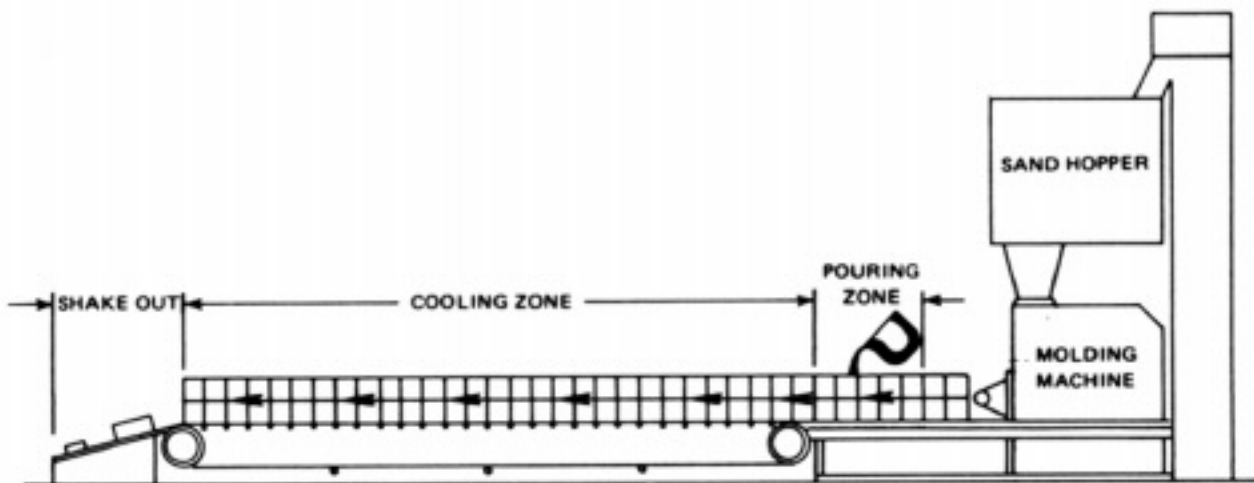

Figure 11—Illustration of Flaskless Fitting Molds.

In recent years several highly automated casting machines have been installed to make soil pipe fittings. Most of these machines use sand molds, although some are designed to use permanent molds. Some are computer operated with process controllers.

**Coremaking:** Core production must actually precede mold preparation so that a sufficient number of cores are available for insertion into the molds.

Most cores made for soil pipe and fittings are shell cores. In this method, sand which has been coated with resin binders is blown into a pre-heated metal core box. The heat sets the resin and bonds the sand into a core that has the external contours of the inside of the core box and the internal shape of the fitting. Automatic shell core machines, such as those shown in Figure 12, are in use throughout the industry. Automatic core setters are shown in Figures 10 and 13.

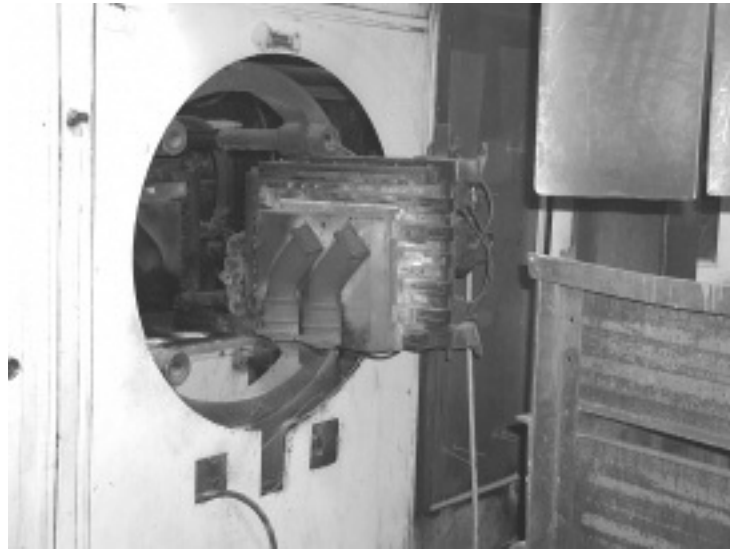

Figure 12—Shell Core Making Equipment.



Figure 13—Automatic Core Setter.

**Pouring:** During the preparation of fitting molds, openings called pouring “sprues” are provided to permit molten iron to enter the mold cavity. Before pouring, molten iron is transported from the melting area in a ladle and then distributed to pouring ladles suspended from an overhead conveyor system. An operator pours the liquid iron into individual fitting molds. (See Figure 14). This may also be accomplished by an automated pouring device.

**Shaking Out:** After pouring, the fittings are allowed to cool inside the mold until the iron solidifies. The hot castings are removed from the mold by dumping the mold onto a grating where the hot sand drops through and is collected for recycling. (See Figure 15.) The castings are then allowed to cool further in the open air. At this stage, they are still covered with a small amount of sand which must be removed in the cleaning department. (See Figure 16.)



Figure 14—Hand-Pouring of Cast Iron Soil Pipe Fittings.



Figure 15—Shakeout.



Figure 16—Castings Being Shaken Out of the Mold.

### *Permanent Mold Casting*

The permanent mold process is an automated process that represents an advance in the production of cast iron soil pipe fittings. Permanent-mold casting produces fittings in reusable, two-piece, water- or air-cooled metal molds. Casting occurs with the molds set in a stationary position on a rectangular indexing line, or on a rotating wheel-type machine. (See Figure 17.) The latter arrangement employs multiple molds mounted in a circle, and as the machine rotates, production steps are performed, some automatically, at various stations.

At the start of the casting procedure, with the two-piece mold in an open position, a coating of soot from burning acetylene is applied to prevent the mold from chilling the molten iron and to prevent the casting from sticking to the mold. A core is then set, and the mold is closed. The mold is



Figure 17—Rotating Wheel-Type Machine for Fittings Production.

then ready for pouring. Molten iron, meanwhile, has been distributed from a large ladle traveling on an overhead monorail system to a smaller pouring ladle. The iron is poured into the fitting molds as shown in Figure 18. The cast fitting solidifies in the mold, which is cooled by a controlled flow of water or by air passing over cooling fins built into the mold. When sufficiently solid, the fitting is released from the mold onto a conveyor for transport to the cleaning department. The mold is then cleaned and made ready for recoating, and the entire production cycle starts once again. The result is a highly efficient casting operation.

### ***Cleaning and Finishing Operations***

***Cleaning:*** After the newly cast pipe and fittings have been removed from their molds and allowed to cool, they must be properly cleaned to remove molding sand, core sand, gates, fins, and risers. The cleaning operation may use any of several methods, including shot blast, tumbling machines, reamers, and grinding equipment. Fins are usually ground off with an abrasive wheel, whereas gates and risers are knocked off with chipping equipment and then ground smooth. Modern conveyor systems and grinding equipment are shown in Figures 19 and 20.

***Inspection & Testing:*** After the castings have been cleaned, they are inspected and tested for strict conformance to all standards and specifications. In the laboratory, test samples undergo more exacting physical testing and chemical analyses. Figures 21 through 26 depict the various analytical tools used to evaluate test samples.

***Coating:*** After inspection and testing, pipe and fittings to be coated are dipped in a bath of coating material. (See Figure 27.) Dipping is the most satisfactory method since it provides a finish which is smooth, glossy, hard but not brittle, and free of blisters and blemishes. The finished pipe and fittings are then moved into storage or prepared for shipment.



Figure 18—Permanent-Mold Casting for Fittings Production.



Figure 19—Grinding Equipment for Foundry Use.



Figure 20—Modern Grinding & Inspection Department.



Figure 21—Energy Dispersive X-Ray Spectrometer: Analysis of Iron, Slag, and Raw Materials.



Figure 22—Unitron Microscope.





Figure 23—Optical Emission Spectrometer (OES):  
Analysis of Irons, Production Control Samples, and Final Product.



Figure 24—Leco Carbon Sulfur Tester: Used to Determine Carbon Equivalent of Cast Iron. Carbon Equivalent Required by CISPI and ASTM Standards to be 4.10 Minimum by Mass.  $CE = \%C + \%S_i/3 + \%P/3$ .



Figure 25—Tensile Tester: Tests Tensile Strength of Cast Iron Test Bar. 21,000 psi Minimum, Required by CISPI and ASTM Standards.



Figure 26—Brinell Hardness Tester: Tests the Hardness of Cast Iron. Additional Quality Control Testing Performed by CISPI Members Not Required by CISPI or ASTM Standards.

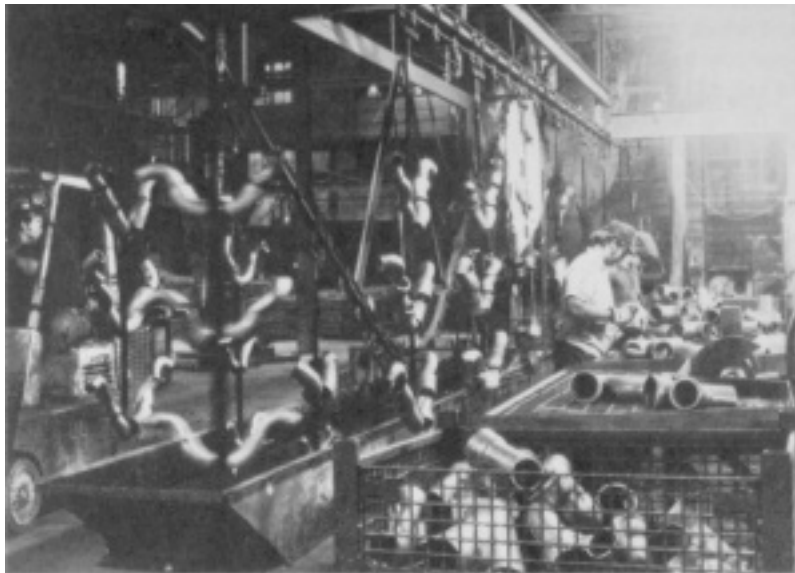

Figure 27—Coating and Inspection of Fittings.

## **NEW TECHNOLOGY AND IMPROVEMENTS IN MANUFACTURING METHODS**

The foregoing abbreviated description of the manufacturing process for cast iron soil pipe and fittings indicates that a number of technological improvements in mechanized production have taken place in recent years. These have increased operating efficiency and improved product quality. The following is a brief review of the principal new techniques and equipment.

### ***The Melting Section***

In the melting section, cupolas are equipped with automatic controls, which insure a uniform melting of the furnace charge. Shutdown for refractory repair and relining is less frequent because of improved refractories or the use of water-cooled shells. The water-cooled cupola can be operated continuously over extended periods and provides additional versatility in the selection and use of raw materials. Oxygen is now commonly available to enrich the cupola air blast in amounts of 1 to 4 percent of the air volume. Air for the cupola blast is also being preheated to temperatures up to 1200°F in externally fired hot-blast systems or in recuperative heating units. The recuperative units utilize the carbon monoxide from the cupola effluent gases as a fuel or extract the sensible heat from the hot gases emitted from the cupola. Divided blast cupolas, where the air blast enters the cupola through two separate levels of tuyeres, are also being used. These new techniques provide increased melting efficiency as well as increases in iron temperature and melting rate.

### ***The Casting Section***

The principal technological advance in the industry has been centrifugal casting, which has long been used to manufacture cast iron pressure pipe. Once it was adapted to soil pipe production, the process was widely accepted and quickly made the hand cast method economically and technologically obsolete. The centrifugal method makes it possible to produce an equivalent tonnage in less time than formerly required and consistently yields high quality pipe of uniform wall thickness.

A parallel advance in fitting production has been the introduction of automatic high production molding systems, which have made dramatic increases in operating efficiency. At the same time, other aspects of fittings production have improved as well. Pattern shops, for example, use the most modern machine tools and the latest patternmaking materials to insure dimensional accuracy. Molding machines for cope-and-drag casting, as well as flaskless molding machines, have eliminated the time-consuming drudgery of hand ramming and contribute greatly to the speed and precision of fitting mold preparation. Finally, these developments have been complemented by the use of automatic core-blowing machines, which have kept core production in step with the simultaneous advances in molding and casting.

## **PATTERNS FOR CAST IRON SOIL PIPE AND FITTINGS**

The manufacture of cast iron plumbing products has gone through several major changes, beginning in the latter part of the 1940s. The demand for cast iron plumbing material increased greatly after World War II. Manufacturers began developing new and better methods that required patterns designed for higher and more economical production.

Automation always requires precise tooling. This led to a product that was uniform and always had precise dimensions. This accuracy of patterning and equipment made possible the

rubber compression gasket joint and the hubless coupling method of joining cast iron soil pipe and fittings.

The process of making cast iron fittings prior to 1945 was extremely slow, requiring a highly skilled foundry molder. The pattern was simply a casting split on its center. The core was made with green sand supported by a cast iron arbor. This process evolved into a matched pattern in a cradle, called a follow-board rollover.

About 1950, aluminum match plates using hinged aluminum core boxes and cast iron arbors became the latest production method. Then, in the mid-fifties, large, machine-made sand molds and machine-made green sand cores on arbors came into use. About 1960, the old green sand core made on an arbor gave way to shell cores made in a hot core box. These shell cores were used in both water-cooled cast iron permanent molds and in green sand molds. In 1970 fittings began to be produced with modern, high-speed molding machines that produce 100 to 150 molds per hour.

The cast iron soil pipe and fittings manufacturers are now using modern, computer-controlled equipment that can produce in excess of 350 molds per hour.

### ***Materials-Handling Equipment***

The latest mechanical equipment is used to handle materials within the foundry and to transport them from one section to another. Cranes and conveyors are used in the storage yard to move pig iron, scrap metal, coke, and limestone. The distribution ladle, filled with molten iron, is moved from the melting area to the casting floor on an overhead rail conveyor or by forklift. Pouring ladles for pipe and fittings are also supported by overhead rail systems. Finished molds are placed mechanically on conveyors for delivery to pouring stations. An overhead conveyor belt transports recovered molding sand to the molding section for use, and another conveyor system carries pipe and fittings to the cleaning and inspection department. Materials handling equipment has mechanized coating operations, and forklifts are used to stack and load packaged fittings and palletized pipe for shipment. Thus, mechanization has been introduced in all phases of the manufacturing process, from the receipt of raw materials to the shipment of finished products.

## **POLLUTION EQUIPMENT**

The passage of the Clean Air and Clean Water Acts of the early 1970s introduced one of the most critical periods of the cast iron soil pipe industry. Government regulations required that air pollution control equipment be installed on melting, sand handling, grinding, and cleaning systems, and that water treatment systems be installed on all industrial wastewater systems.

Very little information was available in the 1970s on pollution control. Many foundries closed their doors because they could not meet the minimum regulations due either to financial or technical problems.

The remaining foundries spent millions of dollars installing pollution control equipment and still spend similar amounts annually to maintain the equipment. More recent environmental regulations will necessitate the expenditure of additional millions of dollars for compliance.

Within the last decade, the soil pipe foundry has gone from a smokestack industry to a leader in clear air and water campaigns. Many of the soil pipe foundries are situated in highly populated areas without anyone being aware of their operations, due to efficient air pollution control.

*Results of Technological Improvements*

- Improved metal quality
- Precision casting with controlled tolerances
- Straighter pipe
- Smoother walls
- More uniform wall thickness
- More uniform hubs and spigots
- Standardized pipe and fitting dimensions providing complete product interchangeability
- Assurance of long-lived, economical, and trouble-free service
- Hubless couplings and compression gasketed joints
- Lower installation cost

# CHAPTER III

## TYPICAL CAST IRON SOIL PIPE LAYOUTS

An understanding of the principles of drainage and venting is essential in laying out a plumbing system. The materials used and the manner in which they are connected determine whether or not the system will function properly and provide satisfactory service. This chapter considers the principles of drainage and venting from the standpoint of some typical cast iron soil pipe layouts.

### STORM DRAINAGE

Drainage for roof areas, courtyards, areaways, and yards is called storm drainage. Storm drains may be connected to a storm sewer or may flow into a sanitary sewer or combination sewer, a gutter or some natural drainage terminal. Municipalities usually have storm sewers constructed to serve privately owned buildings. Wherever the discharge, it should not become a nuisance to adjacent property or to pedestrians.

When connected to a sewage disposal plant, storm drainage can often create a problem by increasing the total volume of sewage that must be treated, thereby increasing costs to the community. If an excessive volume of stormwater is received at the plant, it sometimes becomes necessary to let part of the sewage escape untreated. The contamination of rivers or streams may be injurious to marine life and may make it more difficult to use the water below the disposal plant. Because of this problem, a separate system for storm drainage should be provided where a sewage disposal plant is being used.

Storm drains should not be connected to the sanitary sewer unless permitted by the local code or municipal authorities. When connected to the sanitary sewer or combination sewer, storm drains should be properly trapped and vented. This will allow proper flow and also control sewer gas that may escape through a roof drain. This is particularly important if drainage is being provided from a deck or areaway near windows, or where people may come in contact with the odor of sewer gas. Where connections for storm drainage to a sanitary sewer or combination sewer are not permitted, and a storm sewer is not available, the storm water should be disposed of in a lawful manner as approved by municipal authorities.

#### *Building Sub-Drains and Subsoil Drains*

Subsoil drains placed around the foundation of a building may be connected to a storm drainage system or to a sump. If the building may be subjected to backwater, a backwater valve should be installed to prevent reverse flow. If the sub-drain or sub-soil drain is located below the sewer or discharge level, a pump arrangement and sump may be necessary to lift the water into the drainage system.

#### *Roof Drains*

The plumbing contractor may often have the responsibility for the proper installation of roof drains, including scuppers, leaders and cast iron boots connected to downspouts. Corrosion-resisting mate-

rials of cast iron are recommended, together with suitable strainers and flashing materials. When roof leaders are within a building, pipe space or other area, cast iron soil pipe is recommended. Cast iron soil pipe and fittings are recommended for use with outside leaders, since they are root-proof, withstand heavy backfill and traffic loads, and are permanent.

Tables 1 and 2 provide information on the sizing of roof leaders. A satisfactory method of sizing “vertical” roof leaders is to relate the area of the roof to the diameter of the leader. (See Table 1). The carrying capacity of “horizontal” storm drains varies with the slope of the drain and the diameter of the leader and is based on the projected area of the roof. These variables are shown in Table 2.

A typical roof drain and roof leader is illustrated in Figure 1, and three alternative means of providing roof drainage are diagrammed in Figures 2, 3 and 4.

**TABLE 1**  
*Sizing of Roof Drains and Rainwater Piping for varying Rainfall Quantities and Horizontal Projected Roof Areas in Square Feet*

Rainfall in Inches	Size of Drain or Leader in Inches*					
	2	3	4	5	6	8
1	2880	8800	18400	34600	54000	116000
2	1440	4400	9200	17300	27000	58000
3	960	2930	6130	11530	17995	38660
4	720	2200	4600	8650	13500	29000
5	575	1760	3680	6920	10800	23200
6	480	1470	3070	5765	9000	19315
7	410	1260	2630	4945	7715	16570
8	360	1100	2300	4325	6750	14500
9	320	980	2045	3845	6000	12890
10	290	880	1840	3460	5400	11600
11	260	800	1675	3145	4910	10545
12	240	730	1530	2880	4500	9660

Source: Uniform Plumbing Code (IAPMO) 1985 Edition.

\*Round, square or rectangular rainwater pipe may be used and are considered equivalent when closing a scribed circle equivalent to the leader diameter.

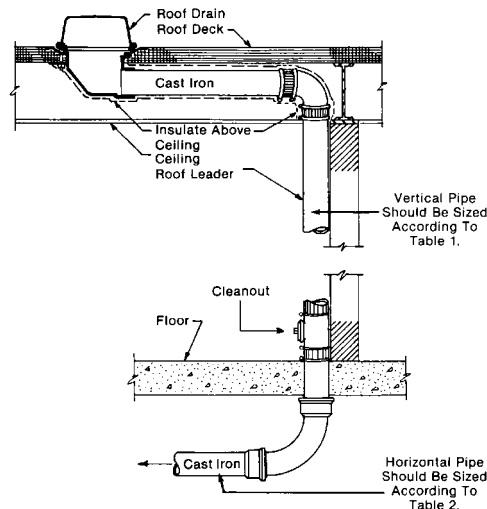

Figure 1—Typical Roof Drain and Roof Leader Joints May Be Either Hubless or Hub and Spigot.

**TABLE 2**  
***Size of Horizontal Rainwater Piping***

Size of Pipe in Inches $\frac{1}{8}$ " Slope	Maximum Rainfall in Inches per Hour				
	2	3	4	5	6
3	1644	1096	822	657	548
4	3760	2506	1880	1504	1253
5	6680	4453	3340	2672	2227
6	10700	7133	5350	4280	3566
8	23000	15330	11500	9200	7600
10	41400	27600	20700	16580	13800
11	66600	44400	33300	26650	22200
15	109000	72800	59500	47600	39650

Size of Pipe in Inches $\frac{1}{4}$ " Slope	Maximum Rainfall in Inches per Hour				
	2	3	4	5	6
3	2320	1546	1160	928	773
4	5300	3533	2650	2120	1766
5	9440	6293	4720	3776	3146
6	15100	10066	7550	6040	5033
8	32600	21733	16300	13040	10866
10	58400	38950	29200	23350	19450
11	94000	62600	47000	37600	31350
15	168000	112000	84000	67250	56000

Size of Pipe in Inches $\frac{1}{2}$ " Slope	Maximum Rainfall in Inches per Hour				
	2	3	4	5	6
3	3288	2295	1644	1310	1096
4	7520	5010	3760	3010	2500
5	13660	8900	6680	5320	4450
6	21400	13700	10700	8580	7140
8	46000	30650	23000	18400	15320
10	82800	55200	41400	33150	27600
11	133200	88800	66600	53200	44400
15	238000	158800	119000	95300	79250

Source: Uniform Plumbing Code (IAPMO) 1985 Edition.



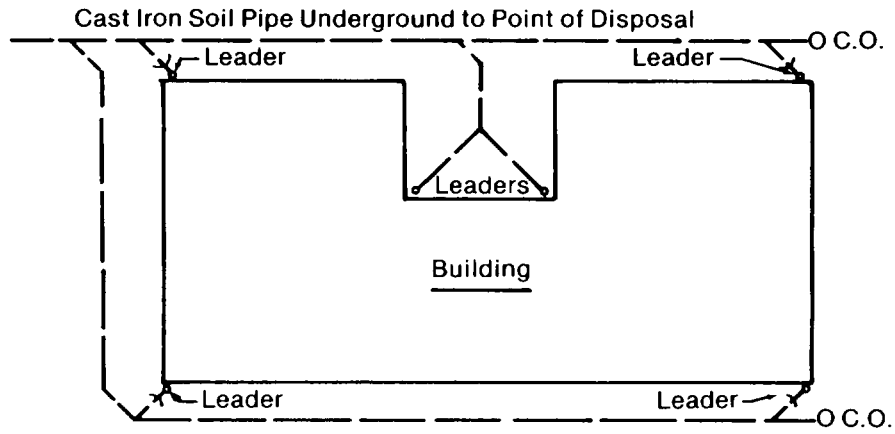

Figure 2—Roof Leaders and Drains Outside Building.

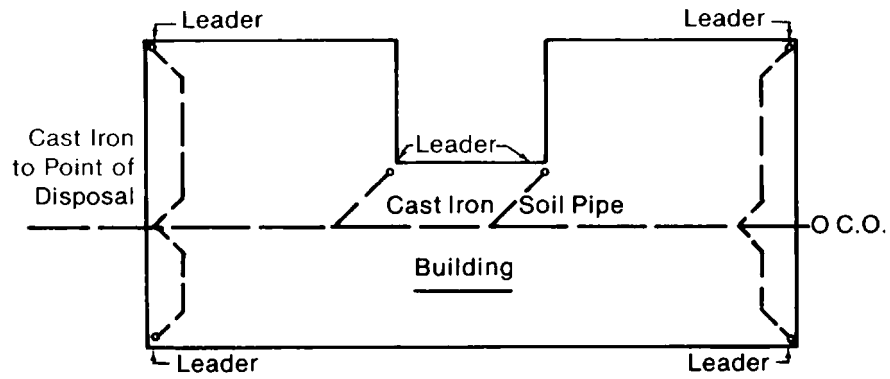

Figure 3—Roof Leaders and Drains Inside Building.

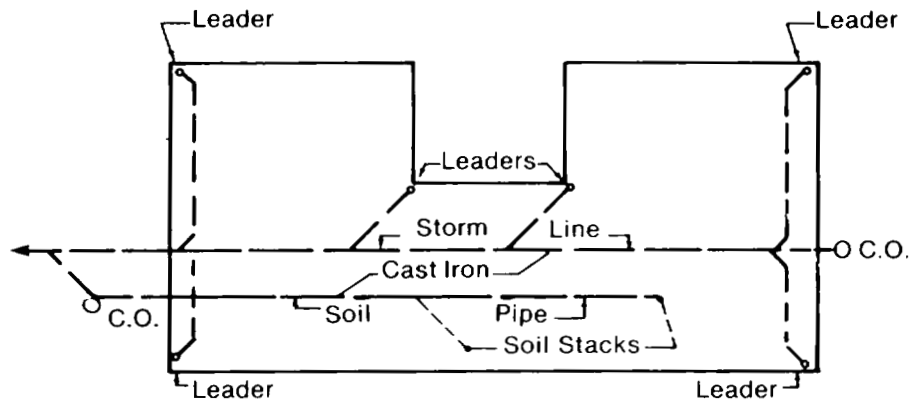

Figure 4—Combination Sewer (Sanitary and Storm) Where Permitted by Code.

## **THE USE OF TRAPS**

If roof drainage is connected to a combination sewer system, traps should be used. Each leader or branch should be individually trapped. Cast iron traps of the same diameter as the leader are recommended and should be located in an accessible area where they can be cleaned out if necessary. A cleanout is also recommended at the base of each leader. Leaves, paper, dust, and trash, along with gravel and even tar from roofing materials, will sometimes require removal.

## **VENTING AND DRAINAGE SYSTEMS**

For a battery of fixtures, venting and drainage may be accomplished by more than one method, as depicted in Figures 5 through 15. In Figure 13 a common vent and a vent header are used. Two other methods with two soil and waste lines each may be used when the batteries are back-to-back with a wide pipe space between them. The difference in venting with these two systems can be observed in Figure 14. Two typical piping arrangements for a water closet, lavatory, and tub are depicted in Figure 15.

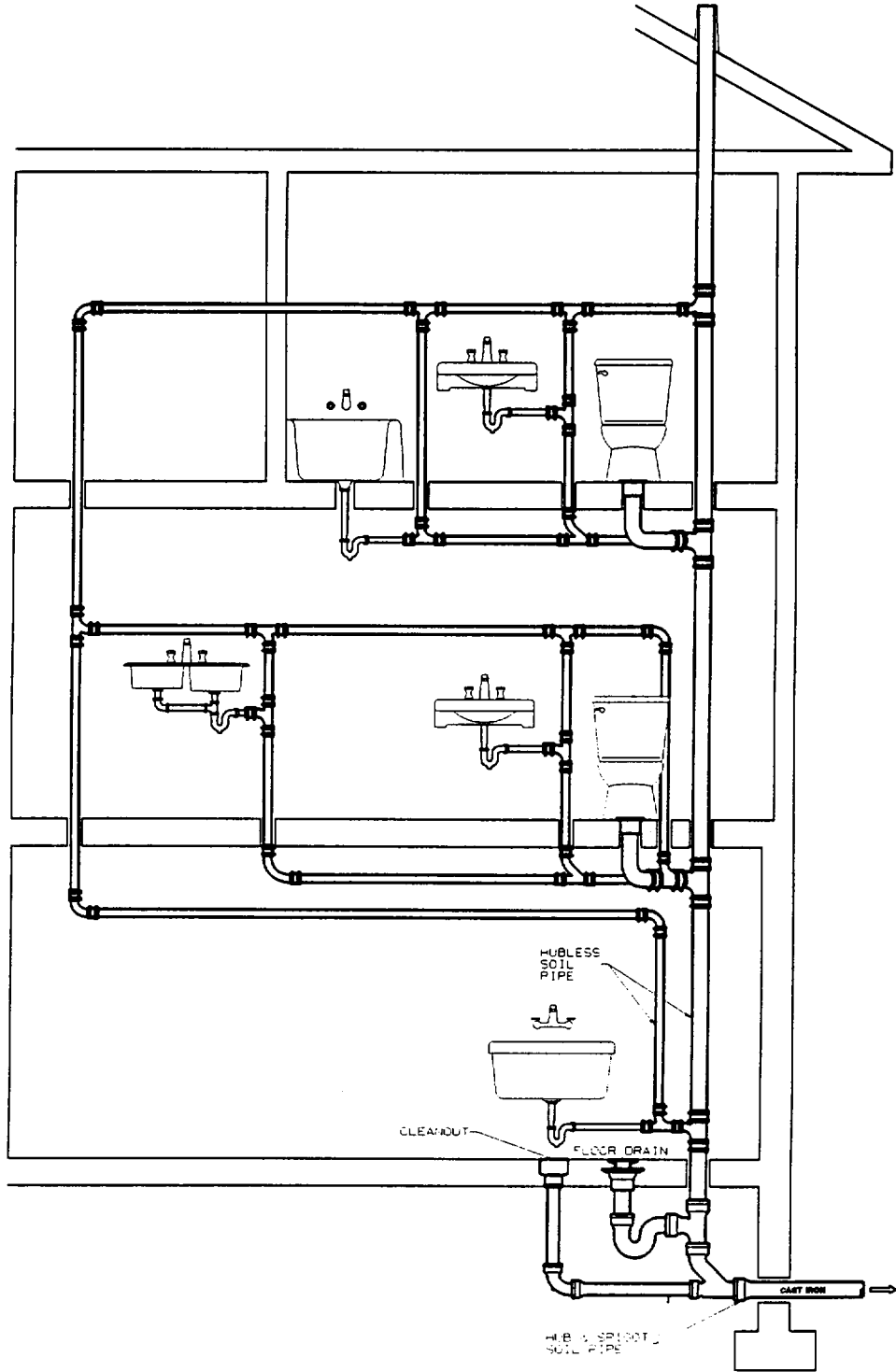
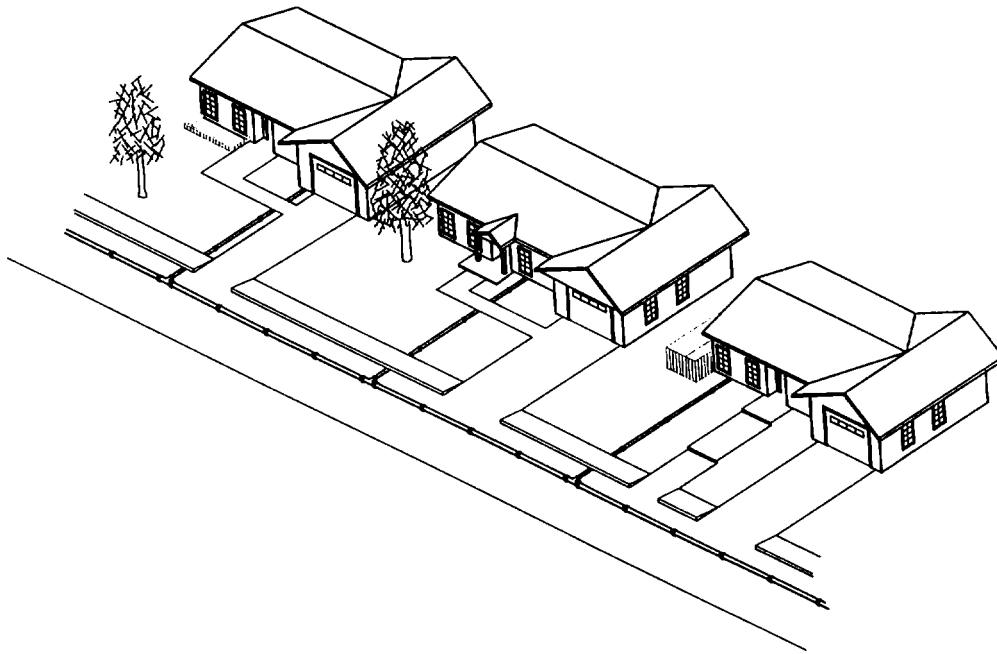
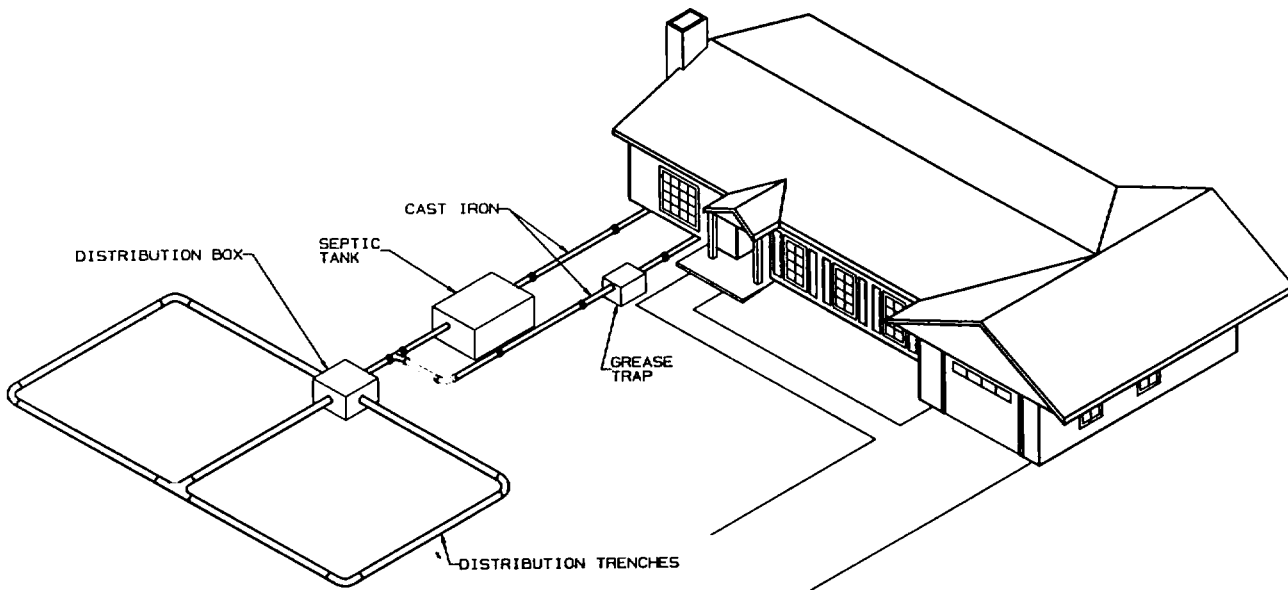

Figure 5—Piping Layout: May be Either Hubless or Hub and Spigot Cast Iron.



(a)



(b)

Figure 6—Typical Piping Layouts and Details for Septic Tank Use: (a) Houses Connected to a Municipal Sewer System; (b) House Connected to a Septic Tank System.

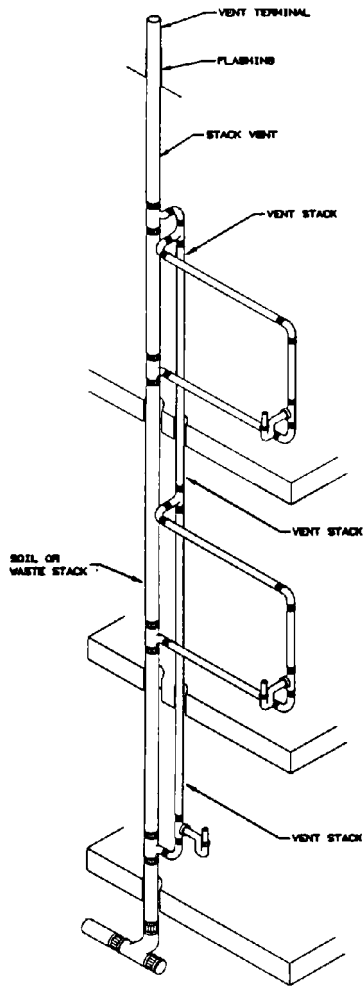

Figure 7—Vent Stack and Stack Vent.

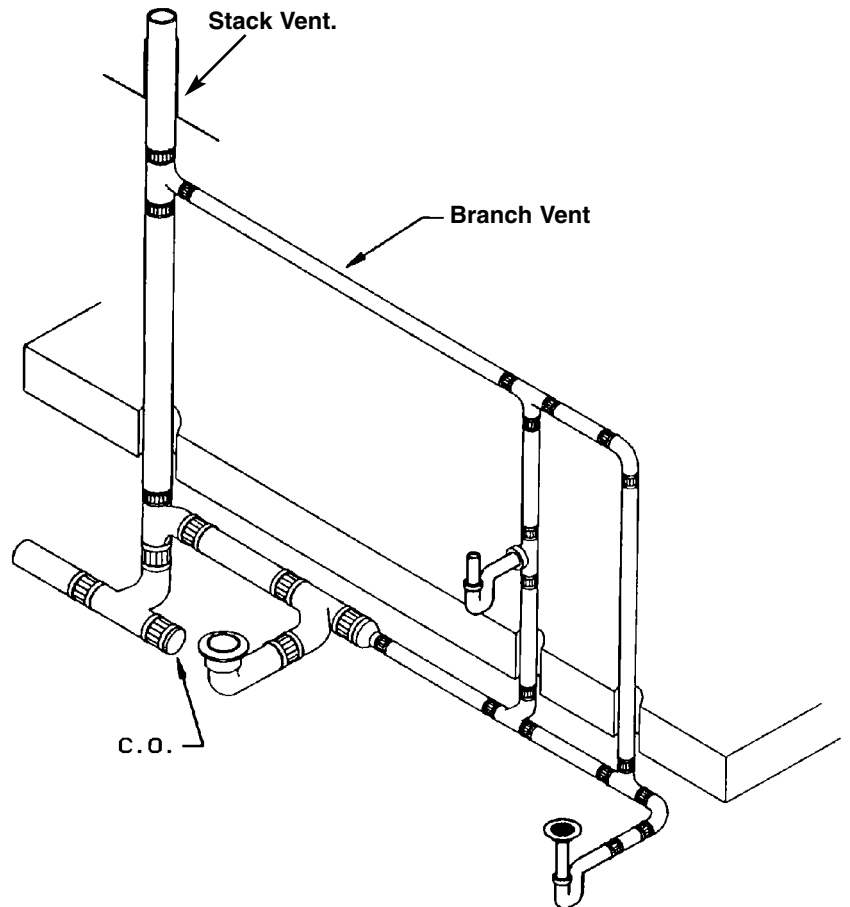

Figure 8—Branch Vent.

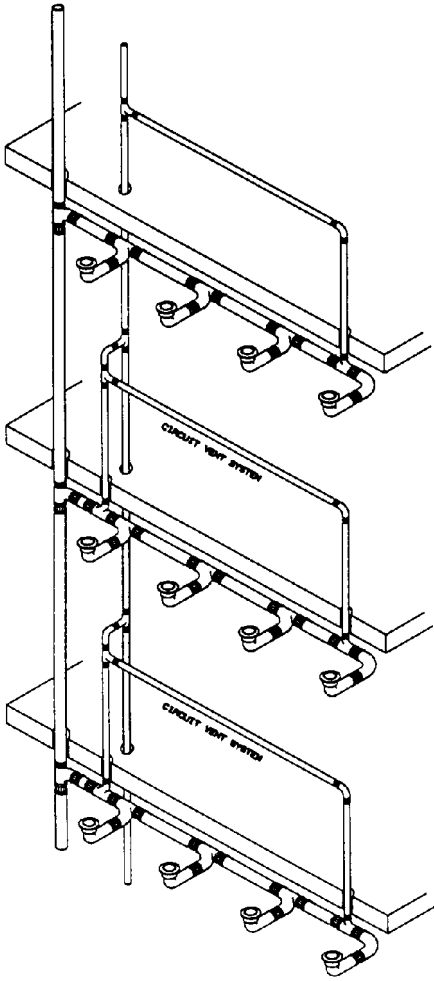
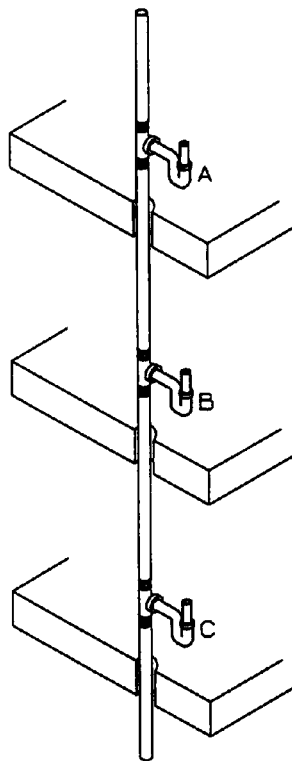

Figure 9—Circuit Venting.



FIXTURE B IS WET VENTED BELOW FIXTURE A.

FIXTURE C IS WET VENTED BY FIXTURE A AND FIXTURE B.

Figure 10—Wet Vent.

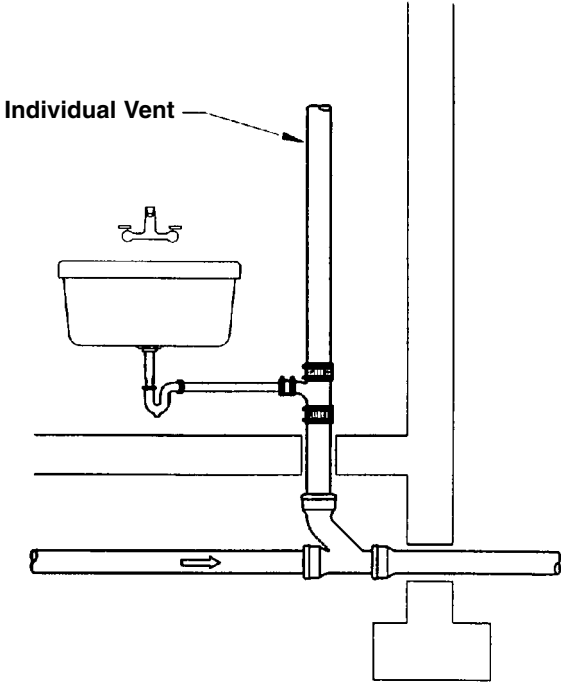

Figure 11—Individual Vent.

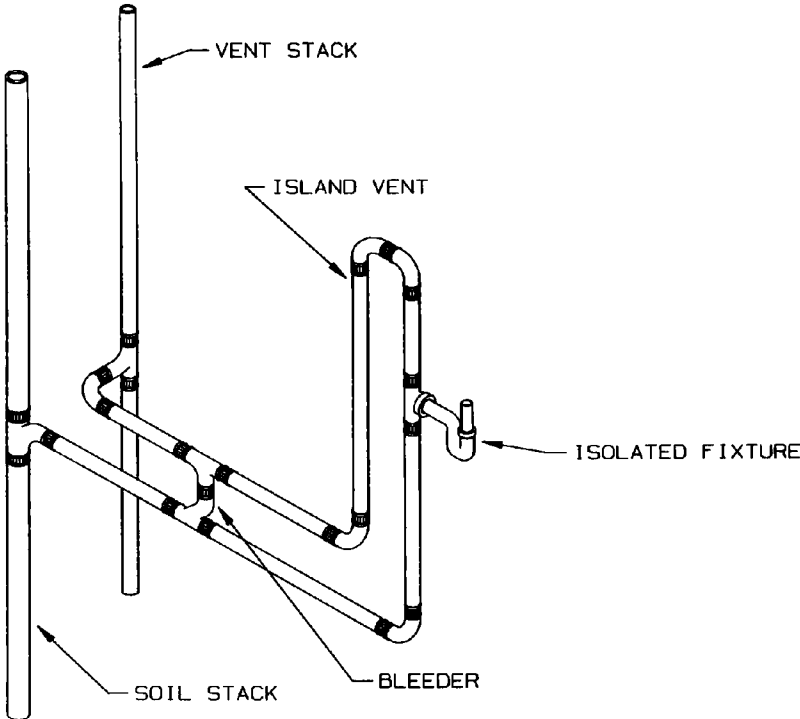

Figure 12—Island Vent.

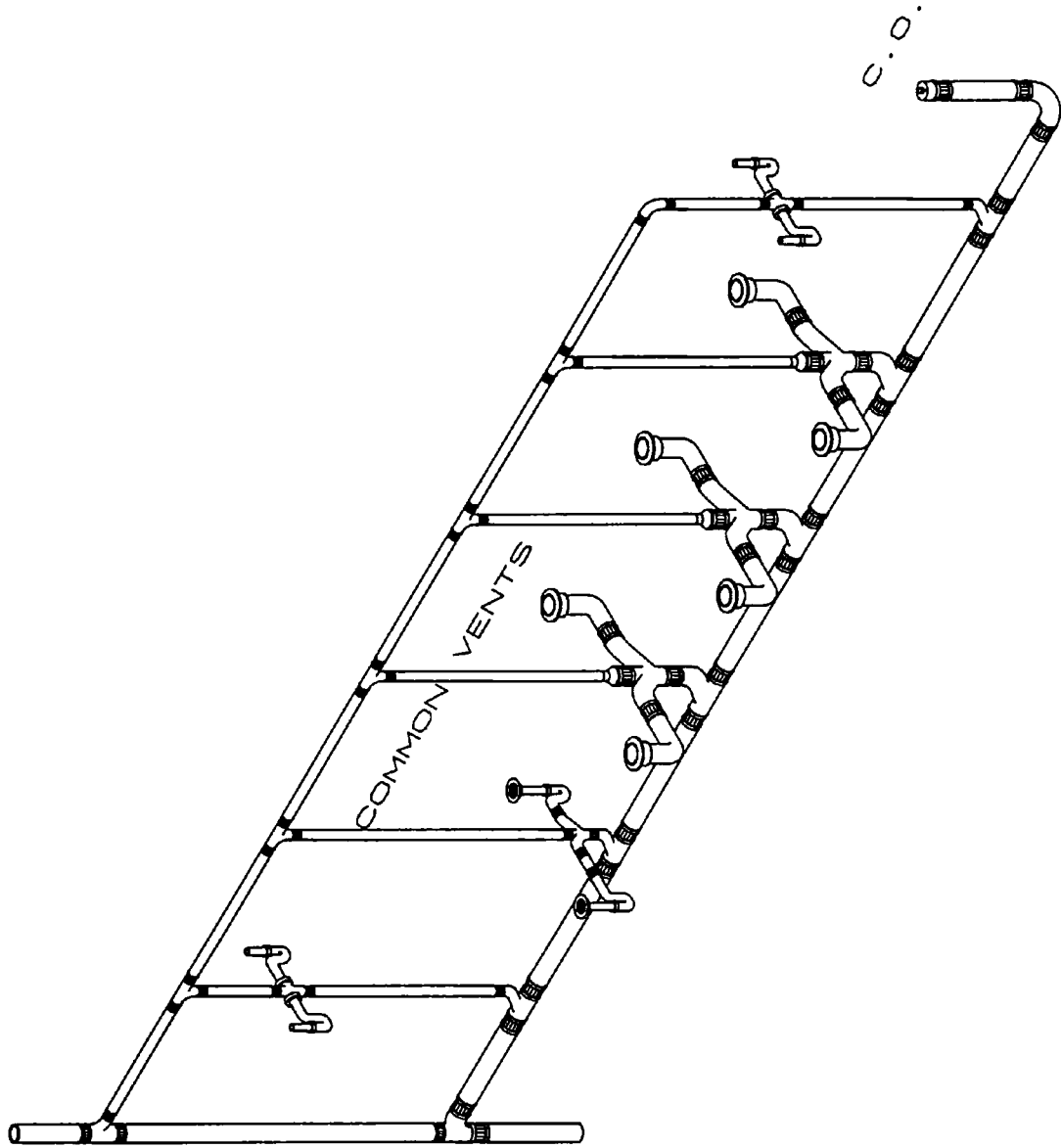

Figure 13—Drainage for a Battery of Fixtures Using Common Vents and a Vent Header.



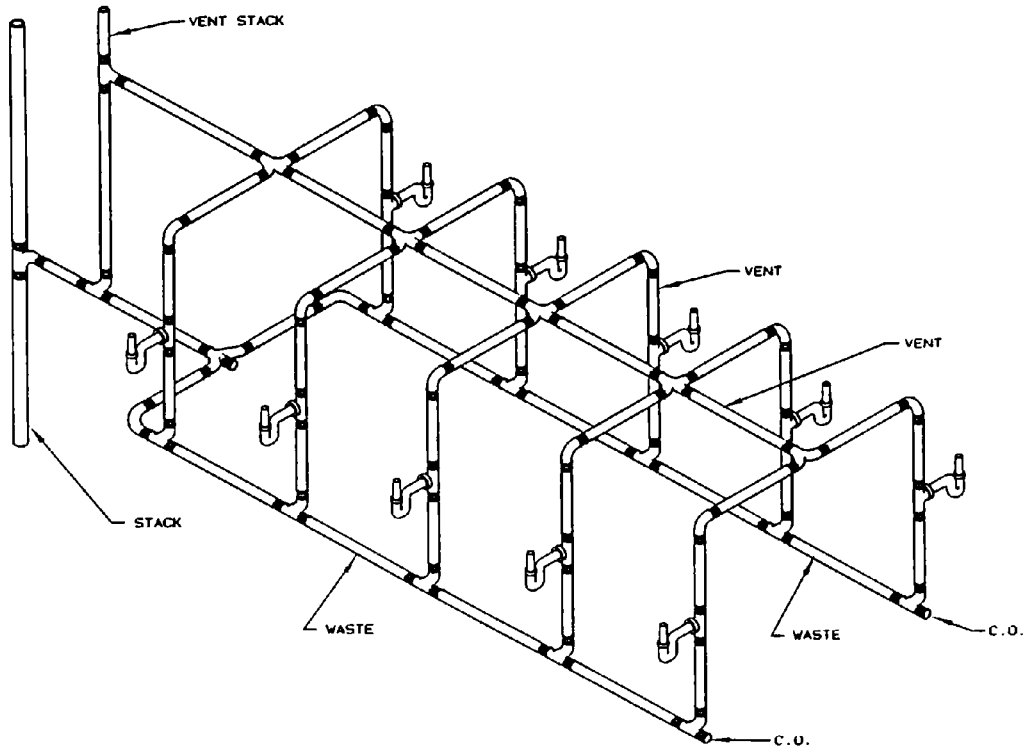
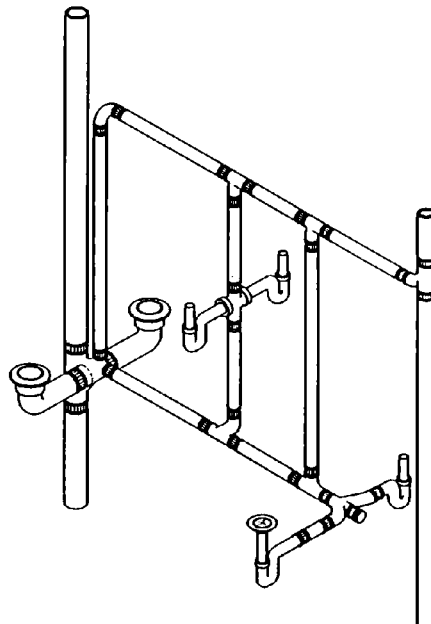

Figure 14—Drainage for a Battery of Fixtures With a Wide Pipe Space Available.



**PIPING FOR TUB, LAVATORY & WATER CLOSET  
EACH FIXTURE VENTED**

Figure 15—Typical Piping Arrangement for a Water Closet, Lavatory and Tub.  
Piping May Be Either Hubless or Hub and Spigot.

# **CHAPTER IV**

## **INSTALLATION OF CAST IRON SOIL PIPE AND FITTINGS**

The installation of cast iron soil pipe and fittings should be completed according to plumbing codes or engineering specifications. Care taken during installation will assure the satisfactory performance of the plumbing drainage system. This chapter presents general installation instructions, as well as information on installing the house or building sewer. It also discusses the problems of infiltration and exfiltration, which can be eliminated by the use of proper installation procedures and materials.

### **HANDLING**

Cast iron soil pipe and fittings are customarily shipped by truck and occasionally by railroad. They will withstand the shocks and stresses normally encountered in transit. The first step upon arrival of the material at the jobsite should be a thorough inspection for damage that may have occurred in transit. The shipment will usually be accompanied with both a bill of lading and a packing list. The purpose of the bill of lading is the legal transfer of title for the material from the manufacturer to the carrier (truck line or railroad) and from the carrier to the wholesaler or installer receiving the shipment. It is very important that any damage be noted on the shipping papers to assure that any claim for damage will be honored. All products should be properly marked with the manufacturer's name or registered trademark, and the county of origin. All items should be checked against the shipping papers or bill of lading and any shortages noted on the delivery receipt or bill of lading. The shipping papers or bill of lading will normally reflect total pieces, bundles, or crates. The packing list will give specific descriptions. It is necessary that the total pieces be checked and any discrepancies or damage noted before the carrier leaves the job site. A copy of this document should be kept in a safe place if damage or shortages are noted.

Many manufacturers of cast iron soil pipe and fittings prepackage pipe in bundles and place these bundles on a truck, trailer, or rail car as a unit. It is possible to unload these packages as a unit. Care should be taken when handling these bundles. Fittings are also prepackaged in crates or boxes. A crate or box tag is attached identifying the contents of each crate. These tags should not be removed, as they will be useful later in locating fittings when they are needed.

### **METHODS OF CUTTING CAST IRON SOIL PIPE**

There are several methods of properly cutting cast iron soil pipe. These methods may be placed into two basic categories: those that require external power for their operation and those methods that require only hand operation. Methods that require external power are usually used for prefabrication work or high volume cutting operations. Examples of this type of equipment include the abrasive saw (chop saw), the power hacksaw, and an electronically actuated hydraulic snap cutter. Before using electrical equipment of this nature, the manufacturer's operating instructions should be carefully reviewed for safe use of the equipment.

There are two hand-operated cutting tools that are used in the industry today: The standard steel pipe cutter using cutting wheels specifically designed to cut cast iron soil pipe; and the snap cutter. The snap cutter accounts for the majority of all cuts made on cast iron soil pipe in the field. For eight-inch and large pipe, and abrasive saw has been found to be the most effective method of cutting. The following procedure has been found to produce consistently good cuts: (1) After marking the pipe length to be cut, position the chain cutter squarely around the pipe to assure a straight cut. The maximum number of wheels possible should be in contact with the pipe. (2) Score the pipe by applying pressure on the handles to make the cutter wheels indent the pipe. (3) Rotate the pipe a few degrees and then apply quick final pressure to complete the cut. If a piece of pipe is unusually tough, score the pipe several times before making the final cut. Scoring the pipe before the actual cut is the key to a clean straight cut.

Cast iron soil pipe may also be cut with a hammer and cold chisel. This method of cutting is very time consuming and should be used only if snap cutters are not available. Again, protective equipment, such as safety goggles, should be used. The procedure for cutting soil pipe with a hammer and chisel are as follows: (1) Measure the length to be cut and mark the cut line completely around the circumference of the pipe. (2) Place the mark to be cut on a 2 x 4 so the edge of the 2 x 4 is directly under the mark. (3) By striking the chisel with the hammer, cut a groove following your mark all the way around the circumference of the pipe. (4) Continue cutting as outlined above in (3) until the pipe is cut. This procedure may take several revolutions of the pipe before it is cut.

Installers should be aware of safety considerations, including the need to use protective equipment such as safety goggles, when cutting cast iron soil pipe.

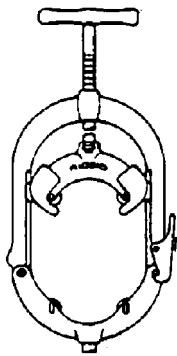

Figure 1—Steel Pipe Cutter.

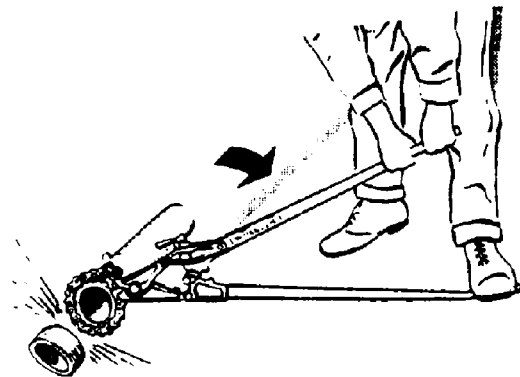

Figure 2—Cutting Pipe With Snap Cutter.

## JOINING METHODS FOR CAST IRON SOIL PIPE

There are generally three methods used for joining cast iron soil pipe. Hub and spigot cast iron soil pipe may be joined by compression gasket or caulked joint. Hubless cast iron soil pipe is joined by using a no-hub coupling.

### *Compression Gaskets*

The compression gasket is a precision-molded, one-piece gasket that is made of an elastomer that meets the requirements of ASTM C-564. The physical characteristics of this elastomer ensure that

the gasket will not decay or deteriorate from contact with the materials flowing in the pipe or chemicals in the soil or air around the pipe. The compression joint is made as follows: (1) Clean the hub and spigot so they are reasonably free from dirt, mud, sand, gravel, and other foreign materials. When installing pipe that has been cut, make sure the sharp edge is removed. The sharp edge may jam against the gasket's seals, making joining very difficult. The sharp edge may be removed by filing or tapping the edge with a ball-peen hammer (2) Fold and insert the gasket completely into the hub. Only the flange that contains the identification information remains exposed on the outside of the hub. (3) Lubricate the joint following the manufacturer's recommendations. Sizes 2" through 15" may be lubricated using a manufacturer's recommended lubricant. Some manufacturers recommend using an adhesive lubricant on large-diameter pipe and fittings (5"–15"). It should be noted that use of adhesive lubricant does not take the place of proper joint restraint when required. (4) Align the pipe so that it is straight. Using the tool of your choice, such as the puller depicted in Figure 4, push or pull the spigot through all of the sealing rings of the gasket. You will feel the spigot end of the pipe bottom out in the hub. Fittings may be installed by using the tool of your choice or by driving the fitting home by using a lead maul. To do this, strike the fitting on the driving lug or across the full hub. Hit it as hard as necessary, the lead will deform without harming the fitting. Using the lead maul is the fastest and easiest way to install fittings on hub and spigot cast iron soil pipe. Proper safety procedures should be observed in making the joint.

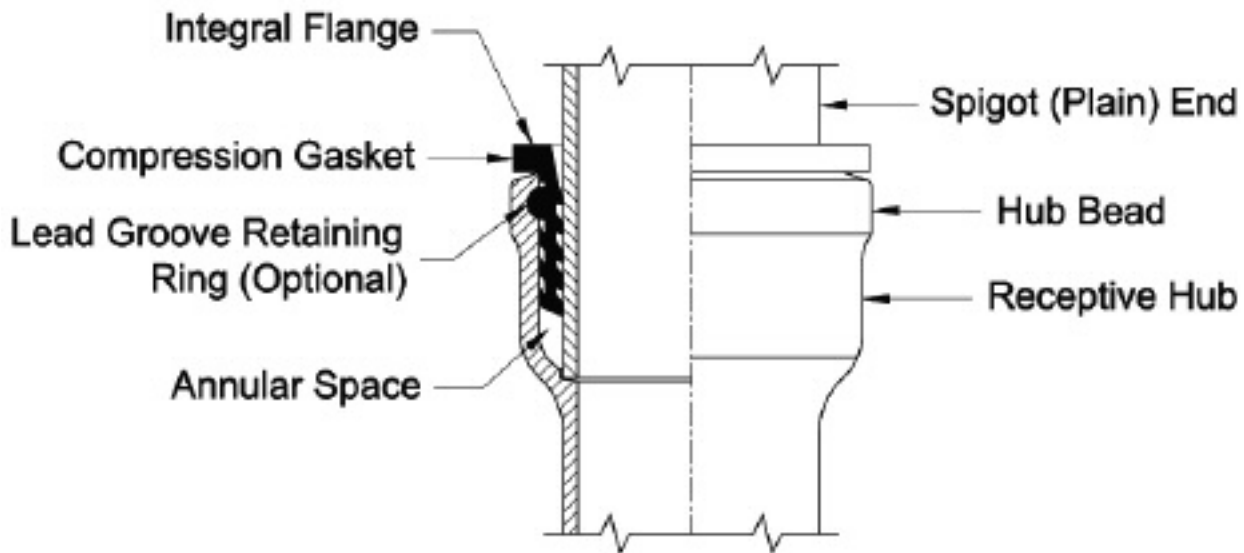

Figure 3—Compression Gasket Joint.

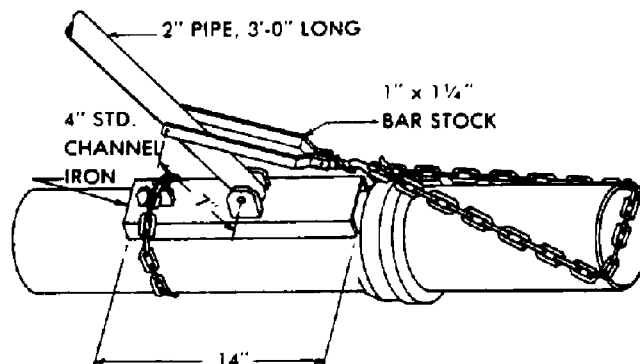

Figure 4—Pulling Assembly.

### Hubless Joints

Hubless cast iron soil pipe is joined by using the no-hub coupling. Several different types of no-hub couplings are available. The following outlines the installation procedures of no-hub couplings that meet the requirements of CISPI 310. It must be noted that these installation procedures are not intended to be applicable for couplings other than those manufactured in accordance with CISPI 310. (See Figure 5.) These couplings are manufactured using a stainless-steel shield-and-clamp assembly and an elastomeric sealing sleeve conforming to the requirements of ASTM C-564. The following steps should be taken to ensure a proper joint: (1) Place the gasket on the end of one pipe or fitting and the stainless steel clamp-and-shield assembly on the end of the other pipe or fitting.<sup>1</sup> (2) Firmly seat the pipe or fitting ends against the integrally molded center stop inside the elastomeric sealing sleeve. (3) Slide the stainless steel shield-and-clamp assembly into position over the gasket and tighten the bands. The bands should be tightened using a calibrated torque wrench set at 60 in./lbs. For larger diameter couplings that have four bands, the inner bands should be tightened first and then the outer bands tightened. In all cases, when tightening bands, they should be tightened alternately to ensure that the coupling shield is drawn up uniformly.

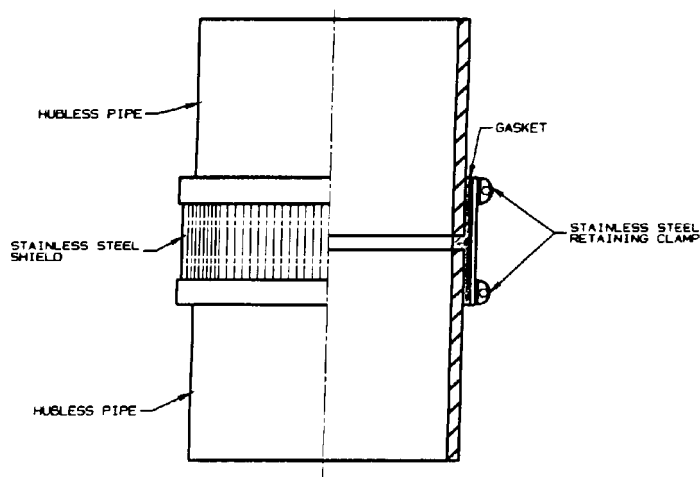

Figure 5—CISPI 310 CI No-Hub<sup>®</sup> coupling.

### Caulked Joints

Oakum is made from a vegetable fiber and is used for packing hub and spigot joints. Cotton and hemp also can be used. These materials are usually twisted loosely into strands or braided and formed into a circular or rectangular cross section. A rough rule-of-thumb method for estimating oakum requirements is to take 10 percent of the weight of the lead required for caulking. Table 1 provides a more accurate method for estimating oakum requirements.

Lead quantities can be roughly estimated by rule of-of-thumb as 12 ounces per inch of diameter as a minimum. Thus, a four-inch diameter pipe would require three pounds of lead as a minimum. An eight-inch diameter pipe would require six pounds of lead. This allows for skimming-off and for a reasonable loss due to spillage in pouring. Table 2 lists suggested lead quantities for various pipe and fitting diameters. The amounts shown apply only to cast iron soil pipe and fittings made according to ASTM Standard A-74.

<sup>1</sup> The use of adhesive lubricants is permissible as recommended by the manufacturer. When adhesive lubricants are used, wait 24 hours before testing. The use of the adhesive lubricant does not take the place of proper joint restraint.

**TABLE 1**  
**Quantity of Oakum Packing Required Per Joint in Standard Hub  
and Spigot Cast Iron Soil Pipe**

Pipe Size in Inches	Tarred or Untarred (Oiled) Twisted Oakum Packing, Pounds	Dry Unoiled Twisted Oakum Packing Pounds (Approx.)	Sq. Braided Oakum Packing Pounds (Approx.) Using I ring
2	.14	.09	.07
3	.16	.10	.08
4	.18	.13	.10
5	.20	.15	.12
6	.21	.16	.13
8	.44	.33	.17
10	.53	.40	.20
12	.61	.46	.24
15	.94	.71	.45

The standards of the Lead Industries Association contain the specification for lead quality. Lead for caulking purposes should contain no less than 99.73 percent of lead and no more than the following maximum allowable impurities: .08 percent copper, .002 percent zinc, .002 percent iron, .25 per cent bismuth, .02 percent silver, and a total of not more than 0.15 percent arsenic, antimony, and tin. The melting point for caulking lead is 621° F, and the proper pouring temperature is 790°–830° F. The lead is ready for pouring when it becomes a cherry red. After cooling, there is a shrinkage of approximately 5.8 percent from the liquid state.

Prior to the late 1950s, the caulked joint was the only method of joining hub and spigot cast iron soil pipe. To make a caulked joint, the following steps are used:

**TABLE 2**  
**Lead Required to Caulk Cast Iron Soil Pipe Joints**

Pipe Size in Inches	Lead Ring Depth Inches	Service SV		Extra heavy XH	
		Cu. Ins.	Wt. Lbs.	Cu. Ins.	Wt. Lbs.
2	1	2.81	1.15	2.91	1.19
3	1	3.90	1.6	4.17	1.71
4	1	4.98	2.04	5.25	2.15
5	1	6.06	2.49	6.24	2.56
6	1	7.15	2.93	7.42	3.04
8	1.25	15.06	6.17	15.49	6.35
10	1.25	18.90	7.75	19.34	7.93
12	1.25	25.53	10.47	26.02	10.67
15	1.5	43.09	17.67	43.38	17.8

(1) The spigot end of a pipe or fitting is placed inside the hub of another pipe or fitting, making sure that both are clean and dry. (2) Oakum is placed in the joint using a yarning iron and then packed to the proper depth by using the packing iron. (See Table 1.) For specifying depth of lead for each size and class, see Table 2. (3) Molten lead is then poured into the joint. The molten lead is brought up to the top of the hub. (4) After the lead has solidified and cooled somewhat, the joint is ready to be caulked. Caulking is performed with inside and outside caulking irons. Caulking the joint sets the lead and makes a leak-free joint.

Any time caulked joints are used, safety procedures should be observed and protective equipment and clothing should be worn. Use customary precautions in using or handling molten lead. If a horizontal joint is to be made, a pouring rope must be used to retain the molten lead in the hub.

Note: The caulked joint is a very time-consuming method of joining cast iron soil pipe. The vast majority of all hub and spigot cast iron soil pipe installed today is joined by using the compression gasket.

## UNDERGROUND INSTALLATION PROCEDURES

The physical properties of cast iron soil pipe make it the best DWV (Drain, Waste, and Vent) material for underground installation. The two keys to proper underground installation are trench preparation and backfilling.

The trench should be wide enough to assemble the joints. Total load on the pipe includes both earth load and truck load. For additional information, refer to CISPI's brochure, *Trenching Recommendations for Cast Iron Soil Pipe*. Safety procedures in trenching should be observed, including provisions to avoid collapse of the trench wall.

The trench bottom should be stable enough to support the complete barrel of the pipe. If possible, the barrel should rest on even and undisturbed soil. In certain conditions, e.g., rocky, it becomes necessary to excavate deeper than needed, then place and tamp backfill material to provide an appropriate bed. Holes should be provided at each joint for the hub or couplings to allow for continuous support of the barrel along the trench bottom. (See Figure 6.) If the ditch must be excavated deeper than the depth of the drainage pipe, place and tamp backfill material to provide uniform support for the pipe barrel.

Many times in the installation of underground soil pipe it is necessary to change the direction of the line. Cast iron soil pipe will allow this through deflection in the joints. Installation should initially be completed in a straight line and then deflected to the appropriate amount. Maximum deflections should not exceed  $\frac{1}{2}$  inch per foot of pipe. This would allow five inches of deflection for a ten-foot piece of soil pipe and  $2\frac{1}{2}$  inches for five-foot pipe. For changes in direction greater than these deflections, an appropriate fitting should be used.

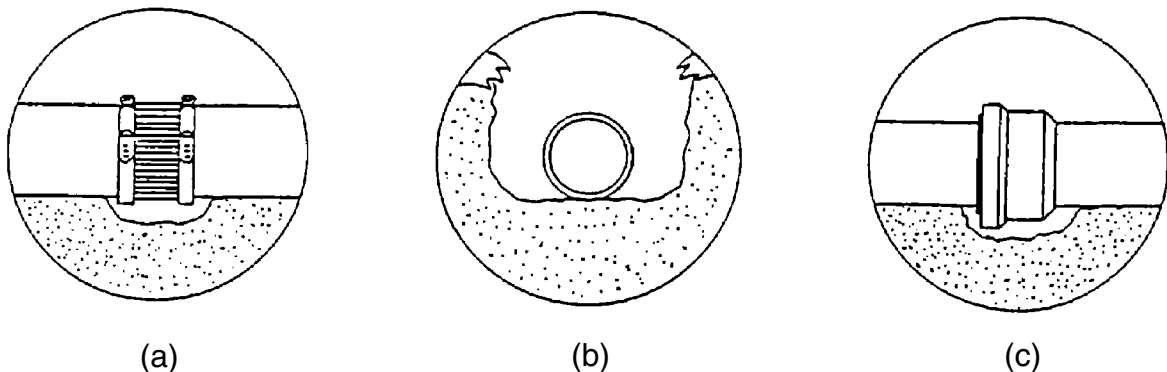

Figure 6—Type 1 Trench Condition: (a) No Pipe Bedding, (b) Hard Trench Bottom, (c) Continuous Line Support with Hub or Coupling Holes.

Once installation is completed (for joining methods, refer to the previous section), the underground section is ready for test. Because this portion of the system is usually the largest diameter pipe, it may be necessary to restrain the system or joints from movement prior to testing. This may be done by partially backfilling and leaving the joints exposed for inspection, or rodding and/or bracing.

After testing is completed, the trench can be properly backfilled. When backfilling, care should be taken to protect the pipe from large rocks, stones, or frozen fill material, that could damage the pipe. Cast iron soil pipe laid on a solid trench bottom requires no tedious placement of selected backfill materials.

Installers should always consider local conditions, codes, manufacturer instructions, and architect/engineer instructions in any installation.

## **ABOVEGROUND INSTALLATION PROCEDURES**

With attention to a few basic rules, the installation of cast iron soil pipe and fittings is easily accomplished. (1) Cast iron soil pipe installed in the horizontal position shall be supported at every hub (hub and spigot) or coupling (hubless). The hanger shall be placed within 18" of the hub or coupling. Joints used for connecting cast iron soil pipe possess sufficient shear strength to require one hanger per joint or hub. (2) Installations requiring multiple joints within a four-foot developed length shall be supported at every other or alternating hubs or couplings. (3) Vertical components shall be secured at each stack base and at sufficiently close intervals to keep the system in alignment and to adequately support the pipe and its contents. Riser clamps, sometimes called floor or friction clamps, are required for vertical piping in multi-story structures in order for each floor not to exceed 15'0".

## **GENERAL INSTALLATION INSTRUCTIONS**

### ***Vertical Piping***

- Secure vertical piping at sufficiently close intervals to keep the pipe in alignment and to support the weight of the pipe and its contents. Support stacks at their bases and at sufficient floor intervals to meet the requirements of local codes. Approved metal clamps or hangers should be used for this purpose.
- If vertical piping is to stand free of any support or if no structural element is available for support and stability during construction, secure the piping in its proper position by means of adequate stakes or braces fastened to the pipe.

### ***Horizontal Piping, Suspended***

- Support horizontal piping and fittings at sufficiently close intervals to maintain alignment and prevent sagging or grade reversal. Support each length of pipe by an approved hanger located not more than 18 inches from the joint.
- Support terminal ends of all horizontal runs or branches and each change of direction or alignment with an approved hanger.
- Closet bends installed above ground should be firmly secured.

### ***Horizontal Piping, Underground***

- To maintain proper alignment during backfilling, stabilize the pipe in the proper position by partial backfilling and cradling.
- Piping laid on grade should be adequately secured to prevent misalignment when the slab is poured.
- Closet bends installed under slabs should be adequately secured.



**Installation Inside the Building**

- According to most authorities and plumbing codes, it is sufficient to support horizontal pipe at each joint, i.e., five-inch pipe should be supported at five foot intervals, ten inch in length may be supported at ten-foot intervals. Supports should be adequate to maintain alignment and prevent sagging and should be placed within 18 inches of the joint. (See Figure 7.)

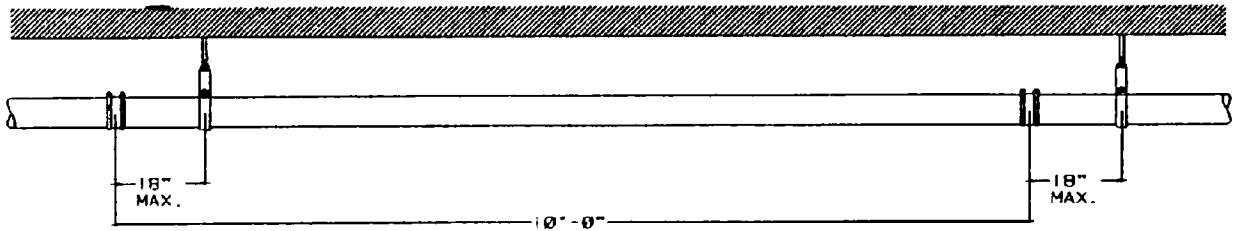

Figure 7—Hanger Spacing for Aboveground Installation.

When the system is filled with water, sufficient beam strength is provided by cast iron soil pipe to carry the load with hangers every 10 feet. Any of the horizontal supports or clamps illustrated in Figures 8(a) and 8(b) may be used, depending on conditions or what is regarded as essential by the contractor, architect, or engineer. Whatever method of support or clamp is used for the horizontal line, care should be exercised to make certain that the line has a proper grade ( $\frac{1}{4}$  inch or more per foot).

Hangers may be fastened to wood members or beams with wood screws, lag screws, or large nails. For fastening to “I” beams, bar joists, junior beams, or other structural members, beam clamps or “C” clamps may be used. Fasteners for masonry walls may be expansion bolts or screws, or where a void is present, toggle bolts may be used. Studs shot into the masonry by the explosion method may also be used. Along a wall, a bracket made of structural members or a cast bracket may be used.

Adequate provision should be made to prevent “shear.” Where components are suspended in excess of 18 inches by means of non-rigid hangers they should be suitably braced against horizontal movement, often called sway bracing. Examples of sway bracing are illustrated in Figure 9.

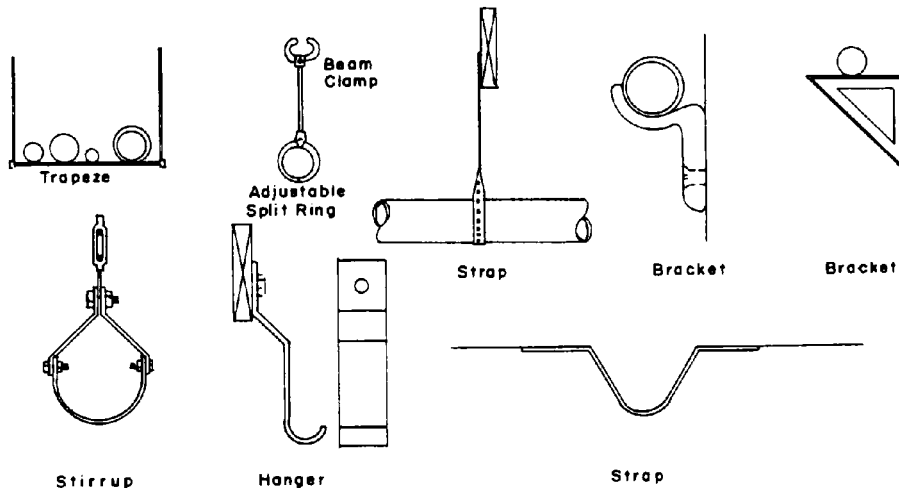

Figure 8(a)—Horizontal Pipe Supports.

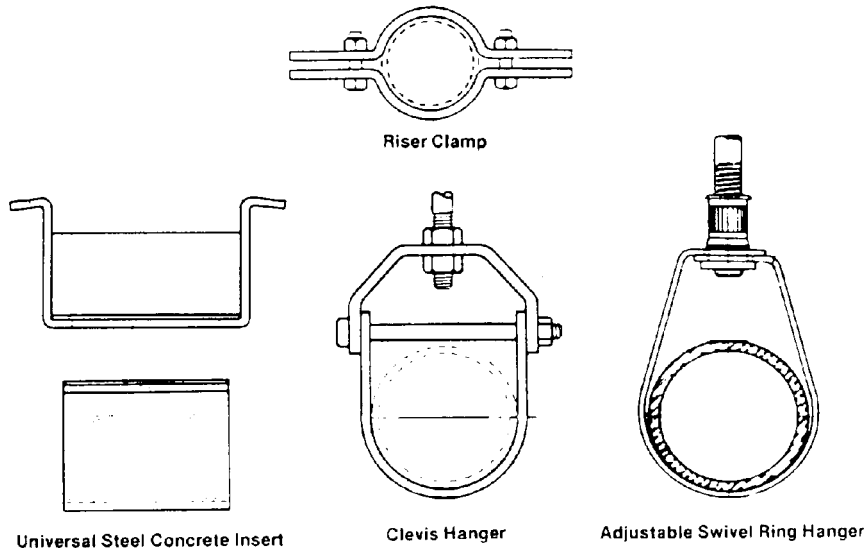

Figure 8(b)—Horizontal Pipe Supports (continued).

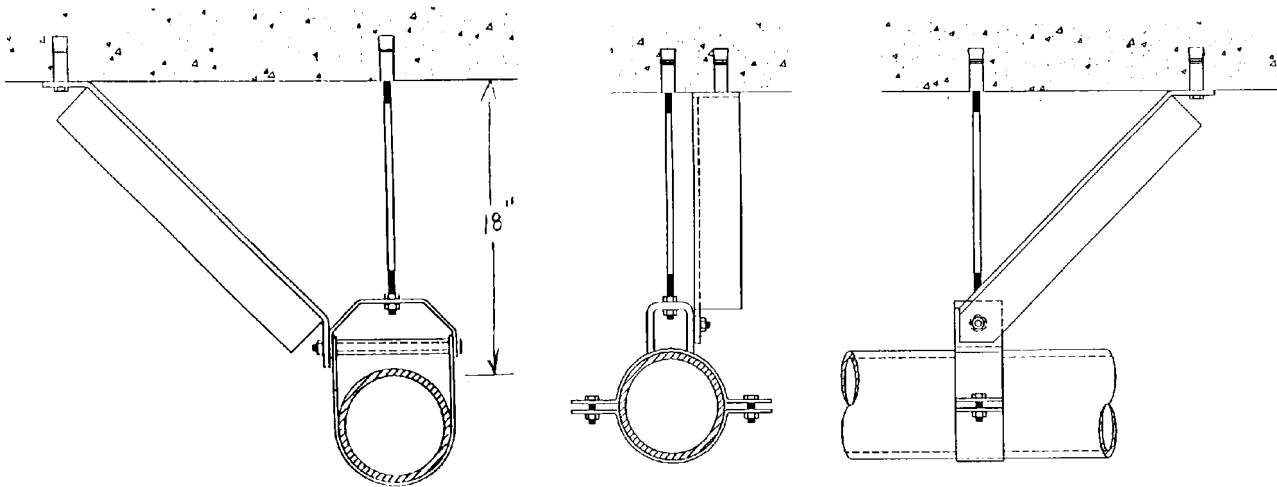

Figure 9—Horizontal Pipe With Sway Brace.

### ***Horizontal Installation of Large Diameter Pipe***

Horizontal pipe and fittings five inches and larger must be suitably braced to prevent horizontal movement. This must be done at every branch opening or change of direction by the use of braces, blocks, rodding or other suitable method, to prevent movement or joint separation. Figure 10 illustrates several methods of bracing.

### ***Suggested Installation of Horizontal Fittings***

- Hangers should be provided as necessary to provide alignment and grade. Hangers should be provided at each horizontal branch connection. Hangers should be adequate to maintain alignment and prevent sagging and should be placed adjacent to the coupling. By placing the hangers properly, the proper grade will be maintained. Adequate provision should be made to prevent shear.

Where pipe and fittings are suspended in excess of 18 inches by means of non-rigid hangers, they should be suitably braced against movement horizontally, often called sway bracing. Refer to Figure 10 for illustrations.

- Closet bends, traps, trap-arms, and similar branches must be firmly secured against movement in any direction. Closet bends installed above ground should be stabilized. Where vertical closet studs are used they must be stabilized against horizontal or vertical movement. In Figures 11 and 12, see illustration for strapping a closet bend under a sub-floor and how a clevis type hanger has been used.
- When a hubless blind plug is used for a required cleanout, the complete coupling and plug must be accessible for removal and replacement.
- The connection of closet rings, floor and shower drains and similar “slip-over” fittings, and the connection of hubless pipe and fittings to soil pipe hubs may be accomplished by the use of caulked lead and oakum or compression joints.

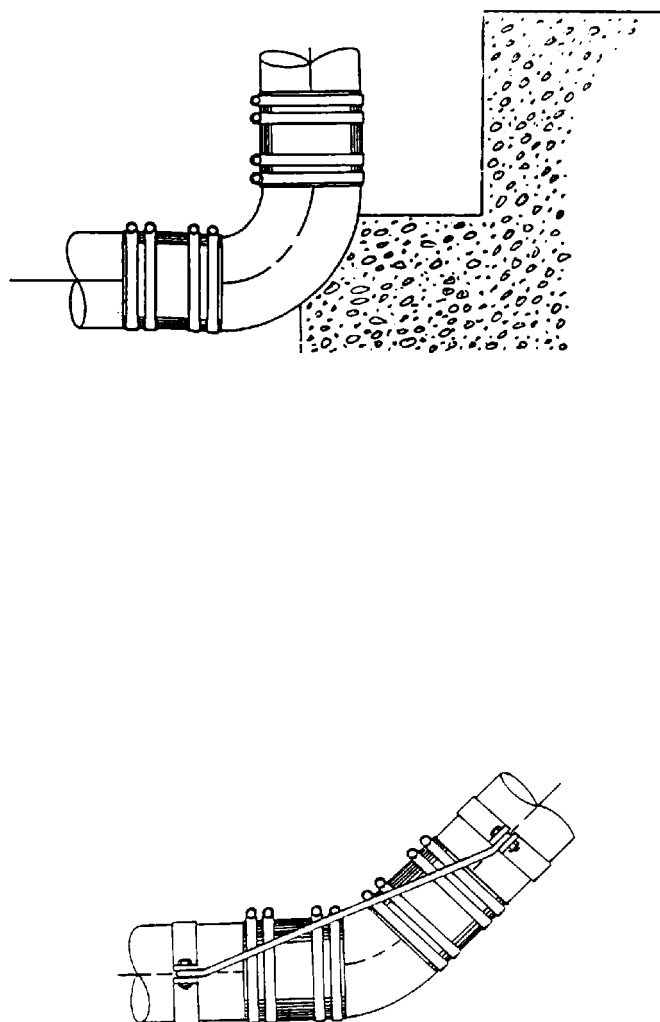

Figure 10—Bracing of Large-Diameter Pipe (continued on facing page).

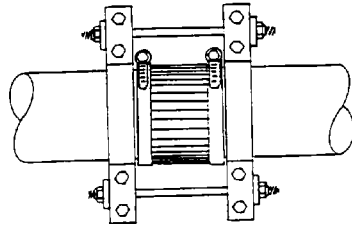

Figure 10—Bracing of Large-Diameter Pipe (continued).

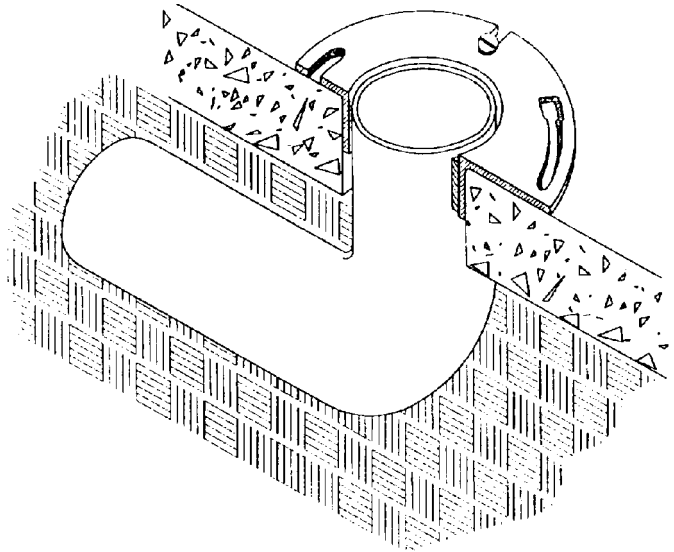

Figure 11—Cross-Section View of Closet Bend Showing Flange Properly Secured.

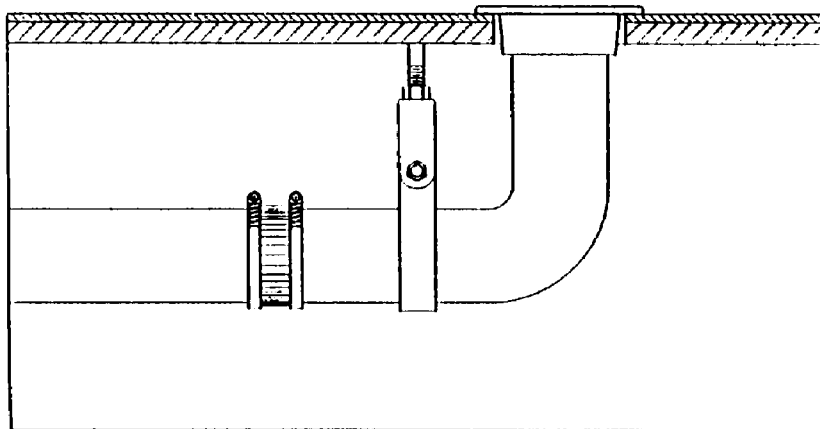

Figure 12—Method of Using Hanger for Closet Bend.

**Vertical Piping**

Vertical components should be secured at each stack base and at sufficiently close intervals to keep the system in alignment and to adequately support the weight of the pipe and its contents. Floor clamps, sometimes called friction clamps, are required for vertical piping in multistory structures so that each floor carries its share of the load. Figures 13 and 14 show some typical brackets or braces for vertical piping. Figure 15 shows a method of clamping the pipe at each floor using a friction or floor clamp.

If vertical piping is to stand free of any support, or if no structural element is available for support and stability during construction, secure the piping in its proper position by means of adequate metal stakes or braces fastened to the pipe.

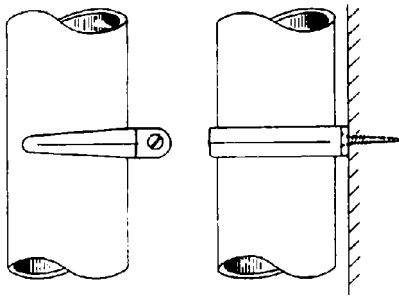

Figure 13—Bracket for Vertical Pipe.

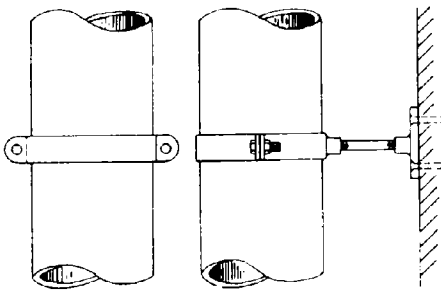

Figure 14—One Hole Strap for Vertical Pipe.

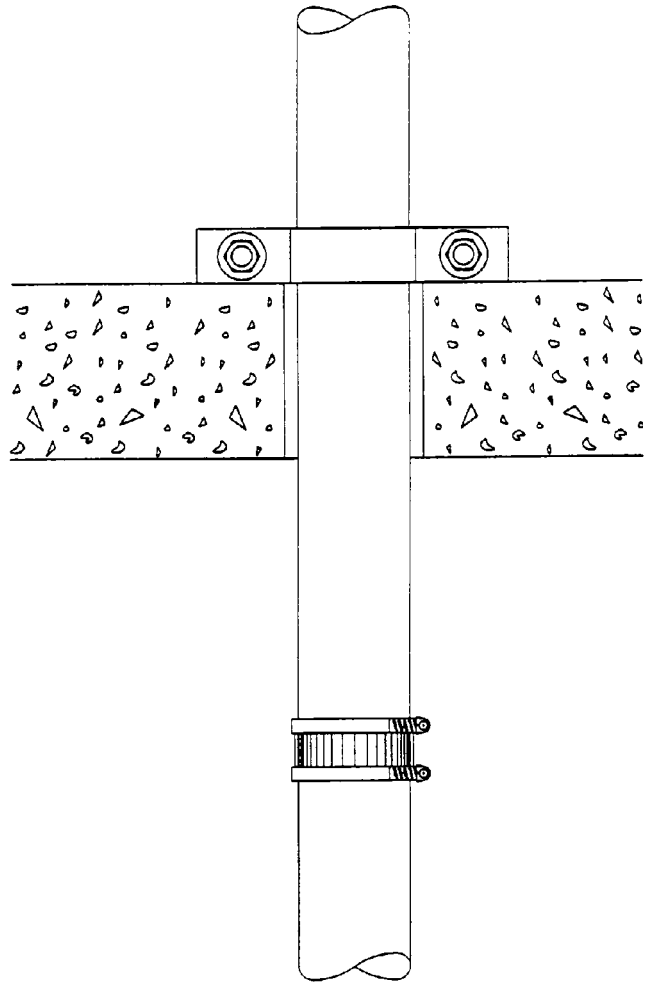
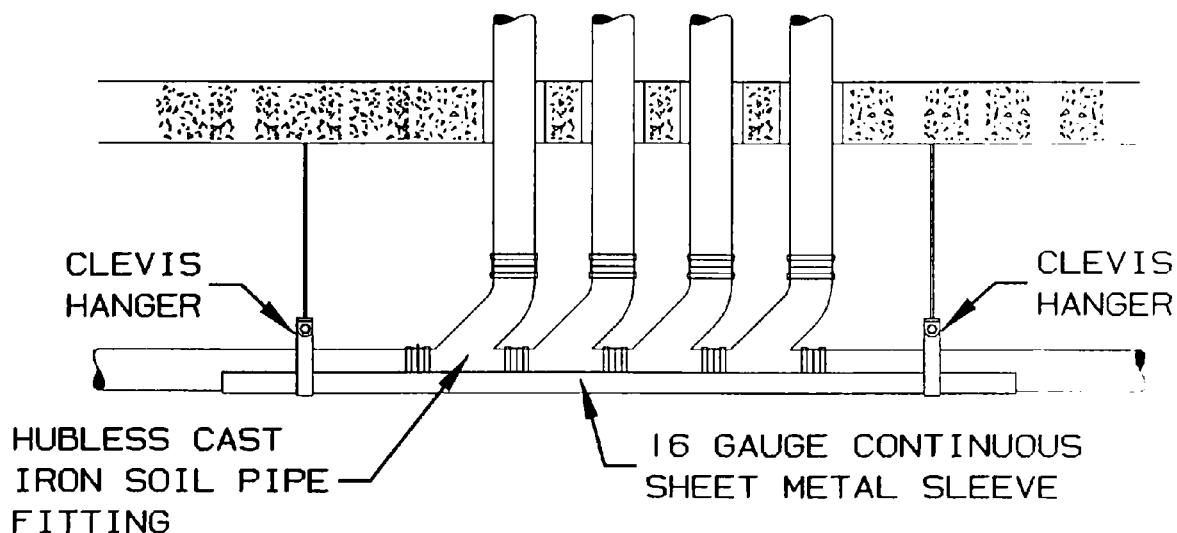

Figure 15—Method of Clamping the Pipe at Each Floor, Using a Friction Clamp Floor Clamp.

### Seismic Restraints

The following recommendations are some of the factors to consider when installing cast iron soil pipe in seismically active areas. All installations must comply with local codes and instructions of architects or engineers who are responsible for the piping design.

- Brace all pipe two inches and larger. Seismic braces may be omitted when the top of the pipe is suspended 12 inches or less from the support-structure member and the pipe is suspended by an individual hanger.
- Vertical Piping Attachment: Vertical piping shall be secured at sufficiently close intervals to keep the pipe in alignment and carry the weight of the pipe and contents. Stacks shall be supported at their bases and if over two stories in height at each floor by approved floor clamps. At vertical pipe risers, whenever possible, support the weight of the riser at a point or points above the center of gravity of the riser. Provide lateral guides at the top and bottom of the riser and at intermediate points not to exceed 30'-0" on center.
- Horizontal Piping Supports: Horizontal piping shall be supported at sufficiently close intervals to prevent sagging. Trapeze hangers may be used. Where top of the pipe is 12 inches or more from supporting structure, it shall be braced on each side of a change of direction of 90 degrees or more.
- Traverse bracing: 40'-0" o.c. maximum spacing unless otherwise noted. One pipe section may act as longitudinal bracing for the pipe section connected perpendicular to it, if the bracing is installed with 24 inches of the elbow or tee of similar size.
- Longitudinal bracing: 80'-0" o.c. maximum spacing unless otherwise noted.
- Provide large enough pipe sleeves through walls or floors to allow for anticipated differential movements.
- Where multiple shield and clamp joint occur in a closely spaced assembly, such as fitting-fitting-fitting-fitting, etc., a 16-gauge half-sleeve may be installed under the assembly with a pipe hanger at each end of the sleeve.<sup>1</sup>



Note: Seismic braces may be installed at either hanger; braces at both hangers are not required.

Figure 16—Method of Supporting “Multi-Fitting” Installations (Hanger Spacing 10 Ft. Max.).

<sup>1</sup> Reprinted with permission of the Plumbing & Piping Industry Council, Inc.

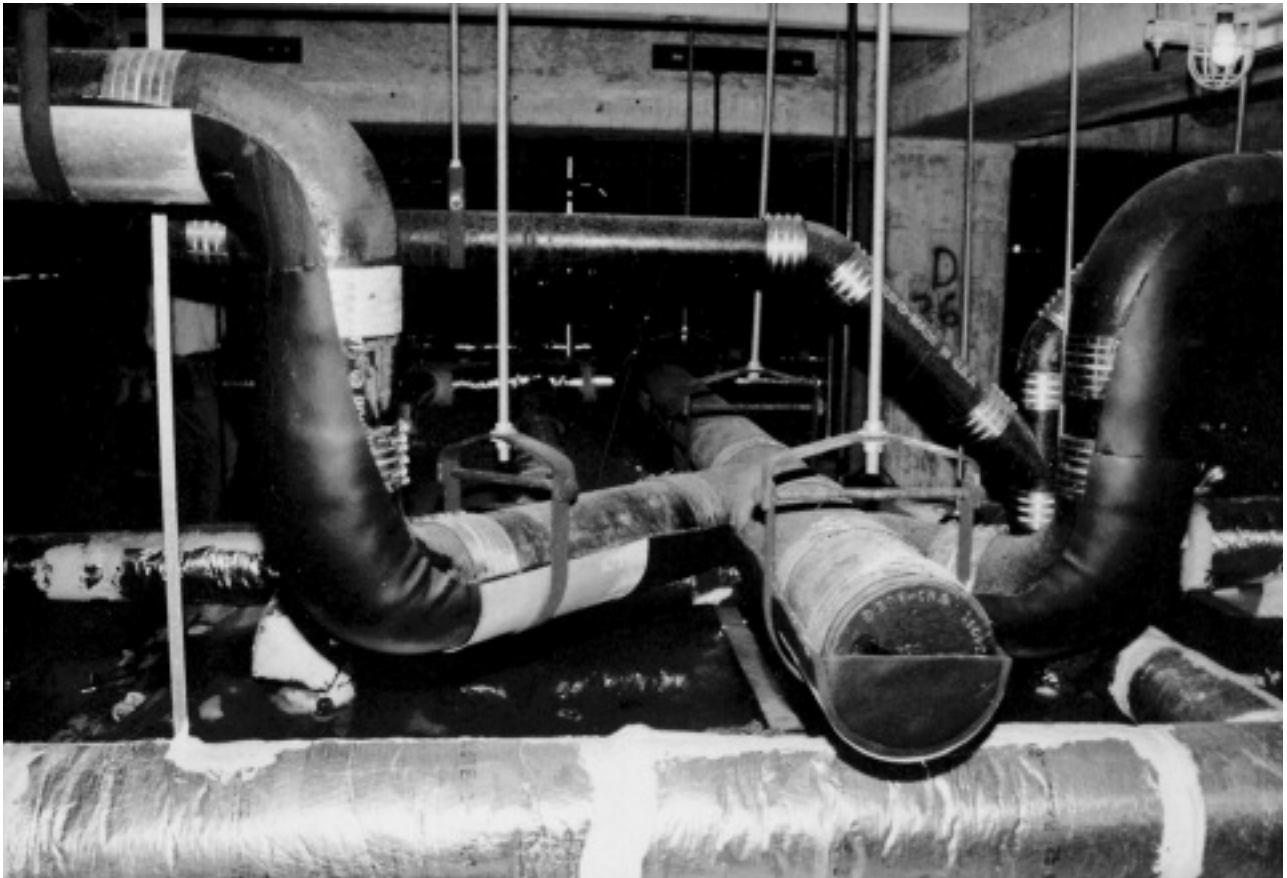

Figure 17—Other Suggestions for Hanging and Supporting Pipes.

## TESTING AND INSPECTION

Once the rough-in is completed on a cast iron piping project, it is important to test and inspect all piping for leaks. The installer usually is required to notify the plumbing inspector of the administrative authority having jurisdiction over plumbing work before the tests are made. Concealed work should remain uncovered until the required tests are made and approved. The manufacturer's identification markings should be visible at the time of inspection. When testing, the system should be properly restrained at all bends, changes of direction, and ends of runs.

There are various types of tests used for installed cast iron soil pipe and fittings. These are water or hydrostatic, air, smoke, and peppermint. Proper safety procedures and protective equipment should be employed during all testing procedures. Installers should always consider local conditions, codes, manufacturer installation instructions, and architect/engineer instructions in any installation.

A water test, also called a hydrostatic test, is made of all parts of the drainage system before the pipe is concealed or fixtures are installed. This test is the most representative of operating conditions of the system. Tests of this type may be made in sections on large projects. After all air is expelled, all parts of the system are subjected to ten feet of hydrostatic pressure (4.3 PSI) and checked for leaks.

### *Air test*

Air tests are sometimes used instead of the water or hydrostatic tests of completed installations. Cast iron soil pipe and fittings joined with rubber compression joints or hubless mechanical cou-

plings are expected to have a reduction in air pressure during a 15-minute test. This drop in air pressure does not indicate a failure of the system or that the system will leak water. Because molecules of air are much smaller than water molecules, a cast iron system is expected to have a reduction in air pressure during the 15-minute test period.

**Caution: Materials under pressure can explode, causing serious injury or death. Extreme care should be exercised in conducting any air test. Persons conducting an air test must exercise care to avoid application of pressure above 6 psig to the system under test by using appropriate pressure regulation and relief devices. Persons conducting the test are cautioned to inspect for tightness of all system components prior to beginning the test and to avoid adjustment of the system while under pressure. Proper protective equipment should be worn by individuals in any area where an air test is being conducted.**

Prior to performing the air test all, threaded openings shall be sealed with a manufacturer's recommended sealant. All additional openings should be sealed using test plugs recommended for use in performing the air test. Some manufacturers recommend the use of adhesive lubricants on the gasketed joints when air testing.

The system shall be pressurized to a maximum of 6 PSI utilizing a gauge graduated to no more than three times the test pressure. The gauge shall be monitored during the 15-minute test period. A reduction of more than 1 PSI during the test period indicates failure of the test. Upon completion of the test, depressurize the system and remove test plugs.

### ***Water Test***

A water or hydrostatic test is the most common of all tests used to inspect a completed cast iron soil pipe installation. The purpose of the test is to locate any leaks at the joints and correct these prior to putting the system in service. Because it is important to be able to visually inspect the joints, water tests should be conducted prior to the "closing in" of the piping or backfill of the underground piping.

As water fills a vertical cylinder or vertical pipe, it creates hydrostatic pressure. The pressure increases as the height of the water in the vertical pipe increases. The Cast Iron Soil Pipe Institute recommends ten feet of hydrostatic pressure (4.3 pounds per square inch); this is the recommended test by most plumbing codes. To isolate each floor or section being tested, test plugs are inserted through test tees installed in the stacks. All other openings should be plugged or capped with test plugs or test caps. (See Figure 18.)

Prior to the beginning of the test, all bends, changes of direction, and ends of runs should be properly restrained. During the test, thrust forces are exerted at these locations. Thrust is equal to the hydrostatic pressure multiplied by area. Thrust pressures, if not restrained, will result in joint movement or separation, causing failure of the test. All air trapped in the system should be expelled prior to beginning the tests.

Once the stack is filled to ten feet, an inspector makes a visual inspection of the section being tested to check for joint leaks. In most cases, where these leaks are found, hubless couplings have not been torqued to the recommended 60 in. lbs. Proper torquing will correct the problem. If leaks occur during testing of hub-and-spigot materials, the joint should be disassembled and checked for proper installation.

Fifteen minutes is a suitable time for the water test. Once the system has been successfully tested, it should be drained and the next section should be prepared for test.



### *Smoke Test*

When a smoke test is required by engineers, architects, or plumbing codes, it is applied to all parts of the drainage and venting systems after all fixtures have been permanently connected and all traps filled with water. A thick, penetrating smoke produced by one or more smoke machines, not by a chemical mixture, is introduced into the system through a suitable opening. As smoke appears at the stack opening on the roof, the opening is closed off and the introduction of smoke is continued until a pressure of 1 inch of water has been built up and maintained for 15 minutes or longer as required for the system. Under this pressure, smoke should not be visible at any point, connection, or fixture. All windows in the building should be closed until the test is completed.

### *Peppermint Test*

Some engineers, architects, and plumbing codes require a peppermint test to be applied to all parts of the drainage and venting system after all fixtures have been permanently connected and all trap seals filled with water. A mixture of two ounces of oil of peppermint and one gallon of hot water is poured into the roof opening of the system, which is then tightly closed. There should be no odor of peppermint within the building at any point, connection, or fixture as a result of the peppermint mixture having been introduced into the system. Operators who pour the peppermint mixture must not enter the building to do the testing. The peppermint test is usually used in old installations to detect faulty plumbing.

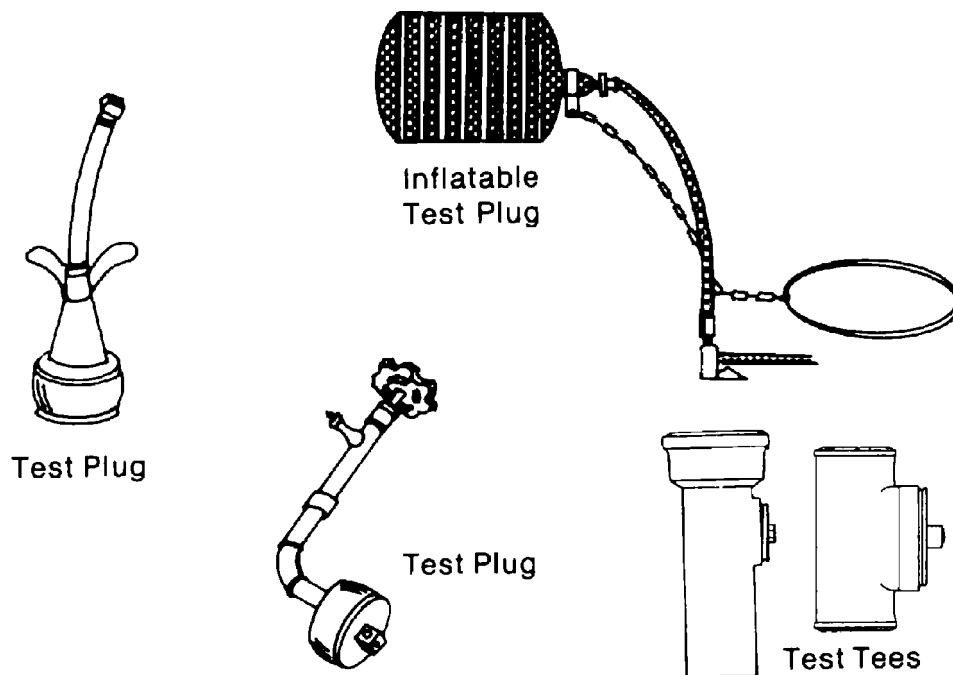

Figure 18—Test Plugs and Test Tees.

### ***Thrust Forces***

Thrust or displacement forces are encountered as the pipe or cylinder is filled with water. The higher the fill the greater the force acting to separate a joint. Table 1 shows the pounds of force tending to cause joint separation when using pipe from 1 1/2 to 15" and a head of water from 10' to 120'.

### **PAINTING CAST IRON SOIL PIPE**

Cast iron soil pipe and fittings that have been factory coated with a bituminous coating can be painted if desired. A primer coat of latex emulsion paint, which is readily available in retail outlets, is applied. Following the latex prime coat, a finish coat of enamel may be applied.

The latex paint prevents the bleeding of the bituminous coating, and the finish coat of enamel in an appropriate color blends the cast iron soil pipe and fittings with the interior surroundings.

### **SIZING SOIL, WASTE, AND VENT LINES**

The sizing of soil, waste and vent lines should be based on "fixture load." The most accurate method of calculating fixture load is by using the "fixture unit basis." One fixture unit is defined as 7.5 gallons of water per minute. A lavatory in a private home is considered to use approximately 7.5 gallons of water per minute under maximum conditions, and other fixtures are governed by this yard stick. For example, a water closet requires more water than a lavatory, and thus it has a higher num-

**TABLE 1**  
***Thrust or Displacement Forces Encountered in  
Hydrostatic Testing of CI No-Hub® Cast Iron Soil Pipe.***

Pipe Size		1 1/2"	2"	3"	4"	5"	6"	8"	10"	12"	15"
Head, Feet of Water	Pressure PSI	Thrust lb.	Thrust lb.	Thrust lb.	Thrust lb.	Thrust lb.	Thrust lb.	Thrust lb.	Thrust lb.	Thrust lb.	Thrust lb.
10	4.3	12	19	38	65	95	134	237	377	538	847
20	8.7	25	38	77	131	192	271	480	762	1088	1714
30	13.0	37	56	115	196	287	405	717	1139	1636	2562
40	17.3	49	75	152	261	382	539	954	1515	2164	3409
50	21.7	62	94	191	327	479	676	1197	1900	2714	4276
60	26.0	74	113	229	392	574	810	1434	2277	3252	5124
70	30.3	86	132	267	457	668	944	1671	2654	3790	5971
80	34.7	99	151	306	523	765	1082	1914	3039	4340	6838
90	39.0	111	169	344	588	860	1216	2151	3416	4878	7685
100	43.4	123	188	382	654	957	1353	2394	3801	5429	8552
110	47.7	135	208	420	719	1052	1487	2631	4178	5967	9400
120	52.0	147	226	458	784	1147	1621	2868	4554	6505	10247
Area, OD. in. <sup>2</sup>		2.84	4.34	8.81	15.07	22.06	31.17	55.15	87.58	125.09	197.06

Thrust = Pressure x Area.

ber of fixture units assigned to it. A pedestal type urinal will use more water than a wall hung urinal, and hence there are different values of fixture units for these fixtures. Another variable to be considered is that a lavatory in a residence will likely use less water than a lavatory in a public building. For this reason, different fixture unit values are assigned for the type of building in which the plumbing fixture is to be used. Table 2 lists the fixture units that have been assigned to the various types of plumbing fixtures and takes into account the type of building (private or public) in which the fixtures are installed. Table 3 lists data for the sizing of vents, and of the building drains. The information in this table has been used with satisfactory results. Code requirements for a given vicinity may vary.

The procedures used to size soil, waste and vent lines are:

- Familiarize oneself with the plumbing code as to the minimum requirements, fixture unit tables, and pipe size tables.
- Add up the fixture units on each branch.
- Add up the total fixture units for the stack.
- If there is more than one stack in the system, add the fixture unit totals for the various stacks.
- From these totals look up the sizes of the pipes in the correct table.
- Compare this size with the minimum allowed by the code; and if it is equal to or greater than the minimum, it is the correct size.

## **INSTALLATION OUTSIDE THE BUILDING**

### ***Excavation and Preparation of the Trench***

The house or building sewer is the underground pipe line for conveying building wastes from a point outside of the building to the city sewer, septic tank or other means of disposal. The sewer trench should be wide enough to provide room to make the joints, align and grade the pipe. For economy, and to avoid the need for fill under the pipe, the trench should not be dug any deeper than necessary. If care is taken to gage the depth of the trench, the pipe will rest on firm undisturbed soil. Mechanical ditching equipment can be used to obtain a neat, uniform trench at a cost per foot generally lower than hand ditching.

Should an unstable condition be found, it may be necessary to over-excavate and place some stable material in the trench on which to place the pipe. Extreme cases such as quicksand or soft muck may require a reinforced concrete cradle or a continuous member supported on a pile foundation to bridge the soft condition. When such extreme conditions develop, a careful examination of the entire area should be made. Advice from qualified engineers and those experienced in soil conditions or foundations may be needed.

In deep-trench installations, the possibility of a cave-in is increased, and it will be necessary to shore the walls or vee the trench as a safety precaution.

When the ditch is exposed to the public, barricades should be erected where required for general safety, and lights should be provided at night.

### ***Line, Grade and Alignment of the House Sewer***

When the house sewer is to be connected to a city sewer, the elevation of the invert of the city sewer is important and should be compared with the invert of the house drain. With this information, the grade of the sewer line can be established. A grade of  $\frac{1}{4}$  inch per foot provides adequate velocity for liquids to carry solids along the pipe.

**TABLE 2**  
***Fixture Units in a Plumbing Drainage System***

Type of Fixture	Minimum Trap & Trap Arm Size		Units
	(inches)	(mm)	
Bathtubs	1½	(38.1)	2
Bidets	1½	(38.1)	2
Dental units or cuspidors	1¼	(31.8)	1
Drinking fountains	1¼	(31.8)	1
Floor drains	2	(50.8)	2
*Interceptors for grease, oil, solids, etc.	2	(50.8)	3
*Interceptors for sand, auto wash, etc.	3	(76.2)	6
Laundry tubs	1½	(38.1)	2
Clotheswashers	2	(50.8)	2
*Receptors (floor sinks), indirect waste receptors for refrigerators, dishwashers, airwashers, etc.	1½	(38.1)	1
*Receptors, indirect waste receptors for commercial sinks, dishwashers, airwashers, etc.	2	(50.8)	3
Showers, single stalls	2	(50.8)	2
*Showers, gang, (one unit per head)	2	(50.8)	
Sinks, bar, private (1½ in. (38.1 mm) min. waste)	1½	(38.1)	2
Sinks, bar, commercial (2 in. (50.8 mm) min. waste)	1½	(38.1)	2
Sinks, commercial or industrial, schools, etc. including dishwashers, wash up sinks and wash fountains (2 in. (50.8 mm) min. waste)	1½	(38.1)	3
Sinks, flushing rim, clinic	3	(76.2)	6
Sinks, and/or dishwashers (residential) (2 in. (50.8 mm) min. waste)	1½	(38.1)	2
Sinks, service	2	(50.8)	3
Mobile home park traps (one (1) for each trailer)	3	(76.2)	6
Urinals, pedestal, trap arm only	3	(76.2)	6
Urinals, stall	2	(50.8)	2
Urinals, wall (2 in. (50.8) min. waste)	1½	(38.1)	2
Wash basins (lavatories) single	1¼	(31.8)	1
Wash basins, in sets	1½	(38.1)	2
*Water closet, private installation, trap arm only	3	(76.2)	4
Water closet, public installation, trap arm only	3	(76.2)	6

\*Note — The size and discharge rating of each indirect waste receptor and each interceptor shall be based on the total rated discharge capacity of all fixtures, equipment or appliances discharged therein, in accordance with Table 4.

Drainage piping serving batteries of appliances capable of producing continuous flows shall be adequately sized to provide for peak loads. Clotheswashers in groups of three or more shall be rated at six units each for the purpose of common waste pipe sizing.

Water closets shall be computed as six fixture units when determining septic tank size based on Appendix A of this publication.

Trap sizes shall not be increased to a point where the fixture discharge may be inadequate to maintain their self-scouring properties.

**TABLE 3**  
**Maximum Unit Loading and Maximum Length of Drainage and Vent Piping**

Size of Pipe (inches)	1/4	1/2	2	2 1/2	3	4	5	6	8	10	12
(mm)	31.8	38.1	50.8	63.5	76.2	101.6	127	152.4	203.4	254	304.8
<b>Max. Units</b>											
Drainage Piping <sup>1</sup>											
Vertical	1	2 <sup>2</sup>	16 <sup>3</sup>	32 <sup>3</sup>	48 <sup>4</sup>	256	600	1380	3600	5600	8400
Horizontal	5	1	8 <sup>3</sup>	14 <sup>3</sup>	35 <sup>4</sup>	216	428	720	2640	4680	8200
<b>Max. Length</b>											
Drainage Piping											
Vertical (feet)	45	65	85	148	212	300	390	510	750		
(m)	13.7	19.8	25.8	45	64.5	91.2	118.6	155	228		
<b>HORIZONTAL (unlimited)</b>											
<b>Vent Piping</b>											
Horizontal and Vertical											
Max. Units	1	8 <sup>3</sup>	24	48	84	256	600	1380	3600		
Max Lengths											
(feet)	45	60	120	180	212	300	390	510	750		
(m)	13.7	18.2	36.5	54.7	64.5	91.2	118.6	155	228		
(See Note)											

<sup>1</sup>Excluding trap arm.

<sup>2</sup>Except sinks and urinals.

<sup>3</sup>Except six-unit traps or water closets

<sup>4</sup>Only four water closets or six-unit traps allowed on any vertical pipe or stack; and not to exceed three water closets or six-unit traps on any horizontal branch or drain.

<sup>5</sup>Based on 1/4 inch per foot slope. For 1/8 inch per foot slope, multiply horizontal fixture units by a factor of 0.8.

Note: The diameter of an individual vent shall not be less than one and one-fourth inches nor less than one-half the diameter of the drain to which it is connected. Fixture unit load values for drainage and vent piping shall be computed from Tables 2 and 3. (Not to exceed one-third of the total permitted length of any vent may be installed in a horizontal position.) (When vents are increased one pipe size for their entire length, the maximum length limitations specified in this table do not apply.)

Source: Uniform Plumbing Code (IAPMO 1985 Edition).

**TABLE 4**  
**Fixture Units and Discharge Capacity (in Gals. per min.) (liters per sec.)**  
**for Intermittent Flow Only**

GPM	L/s		
Up to 7 1/2	Up to .47	Equals	1 Unit
8 to 15	.50 to .95	Equals	2 Units
16 to 30	1.01 to 1.89	Equals	4 Units
31 to 50	1.95 to 3.15	Equals	6 Units

Over 50 gals. per min. (3.15 L/s) shall be determined by the Administrative Authority.

For a continuous flow into a drainage system, such as from a pump, sump ejector, air conditioning equipment, or similar device, two (2) fixture units shall be allowed for each gallon per minute (0.06 L/s) of flow.

Source: Uniform Plumbing Code (IAPMO 1985 Edition).

The house sewer should be run in as straight a line as possible, because changes in direction add resistance to the flow and sometimes cause stoppages. A required change in direction can be accomplished with 1/16 or 1/8 bends. If a sharper bend is necessary, a manhole may be justified. It is good practice to provide a cleanout where sharp changes in direction are made, bringing the cleanout up to grade for easy access. On long straight lines, a cleanout is justified every 100 feet. Suggested cleanouts are illustrated in Figures 19 and 20.

Once the direction of the sewer line has been determined, "grade stakes" should be established and "batter boards" erected. Batter boards are temporary stakes to which a board is nailed or clamped. They are carefully set at a predetermined elevation above the grade line of the sewer. A string, cord, chalk line or wire may be drawn between batter boards in order to check the grade line along the entire length of the sewer.

### *Testing and Inspection of the House or Building Sewer*

Before the house or building sewer is covered with backfill material, it should be inspected visually for alignment. The grade should also be checked with a level. A test should be made to assure tightness of the pipe joints from the house to the street or from the house to the septic tank. The test may be stipulated by a code or by the written specifications for the project. It should be tested at 10 ft. of head, which is 4.34 psi.

### *Placing the Backfill*

One of the most important operations in sewer construction is placing the backfill, and it seldom receives the attention it rightly warrants. Methods of backfilling vary with the length and width of the trench, the type and characteristics of the soil, and general site conditions. Frequently, for commercial and residential work, architects and engineers will write specifications for the backfill

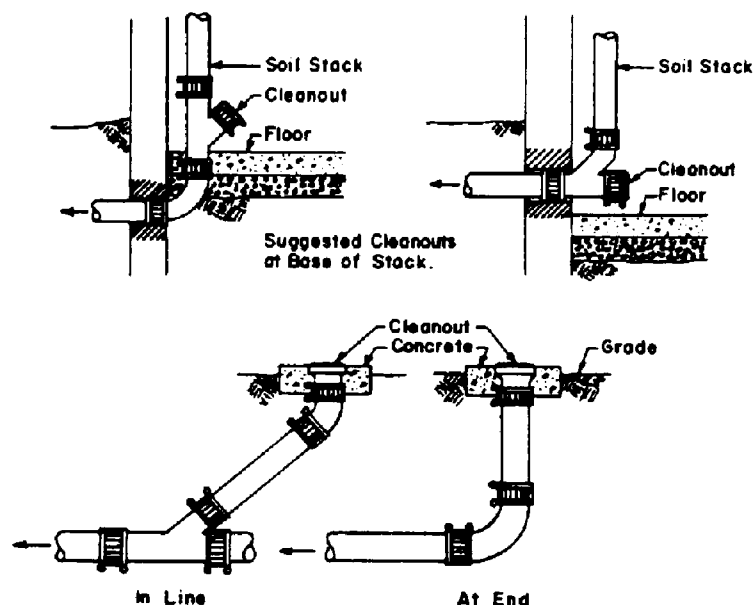

Figure 19—Suggested Cleanouts Using Cast Iron Soil Pipe.

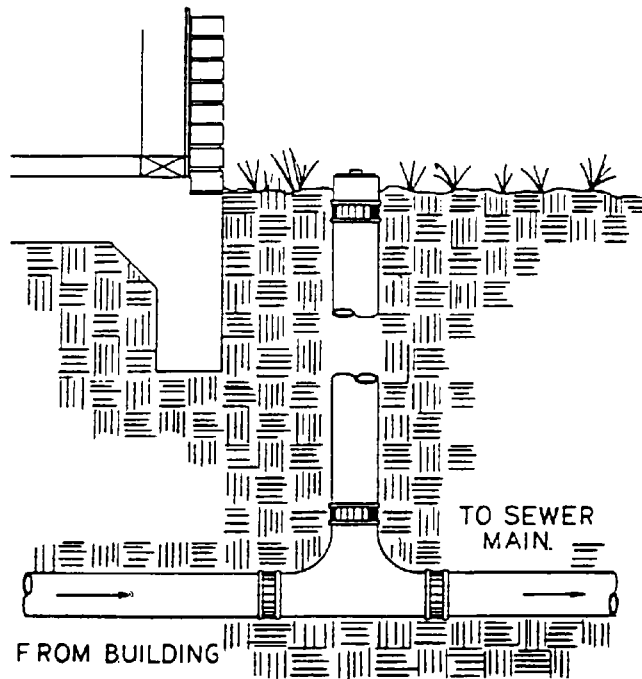

Figure 20—Twin Cleanout.

to be placed in six-inch layers, thoroughly tamped. Grading machinery such as the bulldozer or front-end loader is often used for backfilling. This is an easy way to fill the trench. Unless the backfill is replaced in layers and tamped, it will settle over time and leave a partially filled trench. Puddling the backfill, or water flooding for consolidating the soil, is sometimes used, but it is not always recommended. At certain seasons of the year and with soils of certain characteristics, it may cause difficulty, especially if it freezes or tends to float the sewer out of alignment. Chapter V details proper bedding and backfilling procedures.

### ***Maintenance of the House Sewer***

Maintenance of the sewer consists principally of preventing stoppage, cleaning the sewer if necessary, and repairing it if damaged. Preventive measures can be taken against stoppage. Certain items should never be put in a sewer; these include broken glass, pieces of metal, rock, gravel, sand, feathers, paints, glue, hair, mortar, pieces of rubber, plaster, lumber, cement, and certain liquids. It is unwise to deposit flammable liquids, oil, grease, or certain gases into the sewer system. Some city and state ordinances prohibit steam, steam condensate, and concentrated corrosive acids from being deposited into the sanitary sewer. Not only can these items cause stoppage and damage to the sewer system, but they are sometimes difficult to handle when they reach the sewage treatment plant. They require floating, settling, or screening out, and this can make plant operation costly when an excessive volume is received.

Wastes from laundries, packing houses, creameries, bakeries, garages, hotels, and restaurants, when deposited in the sanitary sewer system, can cause trouble along the sewer line and at the sewage treatment plant. Grease can be removed by having a properly sized and properly connected grease interceptor. It should be inspected and the grease removed at regular intervals.

Clogging of soil and waste lines can often be attributed to improper sizing of pipe and faulty workmanship during installation. A well-designed plumbing system provides a smooth interior

waterway where solids and the semisolids in suspension can be efficiently carried away. When correctly sized waste lines discharge into an oversize line, the velocity changes to a slower rate, and this reduces the scouring action.

Where a sewer is carrying greasy waste, if there is an area where a cooler temperature may affect the line, the grease may solidify and coat the interior of the pipe, causing a stoppage. Heavier solids settle to the bottom of pipes and traps where grease adheres. The use of lye and certain trade-named chemicals to clear lines is seldom recommended, as they sometimes cause soap to be formed from the grease and the pipe then becomes clogged even tighter than before. Such cleaners may damage glazed earthenware, porcelain, and enamel surfaces if improperly used. Flexible coiled-wire augers and sewer rods are usually far more effective and do less damage to the system.

If installed below the frost line, sewers should not be affected by low temperatures.

## PROTECTING CAST IRON PIPE FROM CORROSIVE SOILS

Over 95 percent of the soils in the United States are non-corrosive to cast iron. Those few soils that are somewhat corrosive to cast iron include natural soils containing high concentrations of decomposing organic matter (swamps, peat bogs, etc.), alkalis, or salt (tidal marshes). Man-made corrosive soils result from the discharge of various mining and other industrial and municipal wastes into refuse dumps or landfills.

The National Bureau of Standards and the Cast Iron Pipe Research Association (now known as the Ductile Iron Pipe Research Association, DIPRA) have studied underground corrosion of cast iron pipe for many years. As a result of these studies, a procedure has been developed for determining the need for any special corrosion protection and a simple and inexpensive method of providing such protection using a loose wrap of polyethylene film. The information contained in American National Standard A21.5, American Society of Testing and Materials A674, A74, and A888, and American Water Works Association Specification C 105 provide installation instructions and an appendix that details a ten-point scale to determine whether the soils are potentially corrosive to cast iron.

### *Polyethylene Installation Procedures*

**Material Selection:** Cast iron soil pipe and fittings can be protected from potentially corrosive soils by encasing the system in a loose-fitting polyethylene wrap. Two types of polyethylene have been found to be effective for this procedure: Low-density polyethylene film manufactured of virgin polyethylene material conforming to the requirements of ASTM D 1248 and with a minimum thickness of 0.008 inch.; and high-density cross-laminated polyethylene film manufactured of virgin polyethylene material in accordance with the requirements of ASTM D 1248 and with a minimum nominal thickness of 0.004 inch. Tubular polyethylene wrap should be sized to fit loosely around the pipe, as indicated in Table 5.

Polyethylene encasement protects the pipe from corrosion by preventing contact between the pipe and the surrounding backfill and bedding material, but it is not intended to be a completely airtight or watertight enclosure. All lumps of clay, mud, cinders, and the like that are on the pipe surface must be removed prior to installation of the polyethylene encasement. During installation, care must be exercised to prevent soil or embedment material from becoming entrapped between the pipe and the polyethylene.

The polyethylene film is fitted to the contour of the pipe to effect a snug, but not tight, encasement with minimum space between the polyethylene and the pipe. Sufficient slack should be provided



**TABLE 5**  
***Polyethylene Tube Sizes***

Nominal Pipe Diameter, in.	Recommended Polyethylene Flat Tube Width, in. (cm)
1 <sup>1</sup> / <sub>2</sub> , 2, and 3	14 (35)
4 and 5	16 (41)
6	20 (51)
8	24 (61)
10	27 (69)
12	30 (76)
15	37 (94)

ed in contouring to prevent stretching the polyethylene, especially when bridging irregular surfaces such as hubs, couplings, or fittings, and to prevent damage to the polyethylene due to backfilling operations. Overlaps and ends are secured by the use of adhesive tape, plastic string, plastic tie straps, or any other material capable of holding the polyethylene encasement in place until backfilling operations are completed.

For installations below the water table, in areas subject to tidal action, or both, it is recommended that tube-form polyethylene be used, with both ends sealed as thoroughly as possible with adhesive tape or plastic tie straps at the joint overlaps. It is also recommended that circumferential wraps of tape or plastic tie straps be placed at two-foot intervals along the barrel of the pipe to help minimize the space between the polyethylene and the pipe.

***Protection of Pipe:*** There are three different methods for the installation of polyethylene encasement. Methods A and B are for use with polyethylene tubes, and Method C is for use with polyethylene sheets.

***Method A:***

- (1) Cut the polyethylene tube to a length approximately two feet longer than the length of the pipe section. Slip the tube around the pipe, centering it to provide a one-foot overlap on each adjacent pipe section, and bunch it accordion-fashion lengthwise until it clears the pipe ends.
- (2) Lower the pipe into the trench and assemble the pipe joint with the preceding section of pipe. A shallow bell or coupling hole must be made at joints to facilitate installation of the polyethylene tube.
- (3) After assembling the pipe joint, make the overlap of the polyethylene tube. Pull the bunched polyethylene from the preceding length of pipe, slip it over the end of the new length of pipe, and secure it in place. Then slip the end of the polyethylene from the new pipe section over the end of the first wrap until it overlaps the joint at the end of the preceding length of pipe. Secure the overlap in place. Take up the slack width at the top of the pipe as shown in Figure 21, to make a snug, but not tight, fit along the barrel of the pipe, securing the fold at quarter points.
- (4) Repair any rips, punctures, or other damage to the polyethylene with adhesive tape or with a short length of polyethylene tube cut open, wrapped around the pipe, and secured in place. Confirm and adjust any necessary grade on the piping section. Proceed with installation of the next section of pipe in the same manner.

***Method B:***

- (1) Cut the polyethylene tube to a length approximately one foot shorter than the length of the pipe section. Slip the tube around the pipe, centering it to provide six inches of

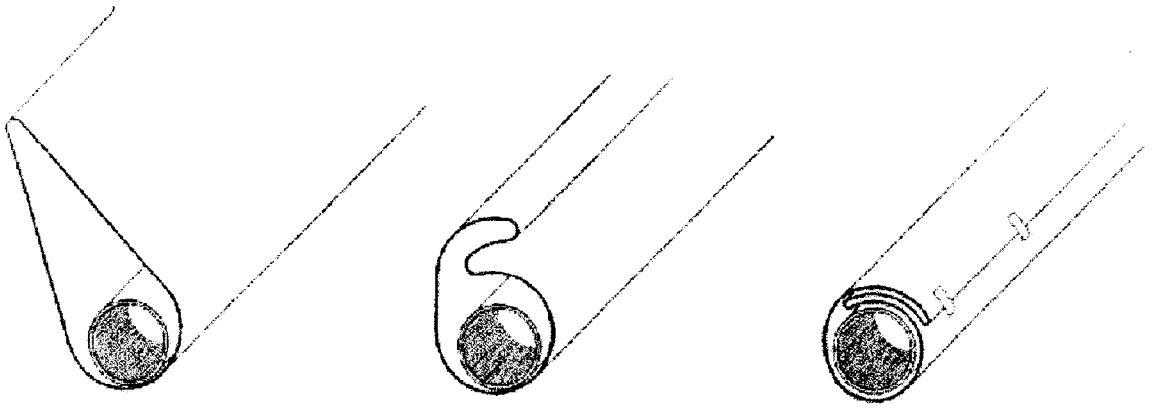

Figure 21—Method A Slack Reduction Procedure.

bare pipe at each end. Make the polyethylene snug, but not tight, as shown in Fig. 21, and secure the ends.

(2) Before making a joint, slip a three-foot length of polyethylene tube over the end of the preceding pipe section, bunching it accordion-fashion lengthwise. After completing the joint, pull the three-foot length of polyethylene previously installed onto each adjacent section of pipe by at least 1 foot; make snug and secure at each end.

(3) Repair any rips, punctures, or other damage to the polyethylene. Confirm and adjust grade on the piping, as required. Proceed with installation of the next section of pipe in the same manner.

**Method C:** Use flat-sheet polyethylene with a minimum width twice that of the flat tube width, as shown shown in Table 5.

(1) Cut the polyethylene sheet to a length approximately two feet longer than the length of the pipe section. Center the cut length to provide a one-foot overlap on each adjacent pipe section, bunching it until it clears the pipe ends. Wrap the polyethylene around the pipe so that it overlaps circumferentially over the top quadrant of the pipe. Secure the cut edge of polyethylene sheet at approximately three-foot intervals along the pipe length.

(2) Lower the wrapped pipe into the trench and assemble the pipe joint with the preceding section of pipe. A shallow hub or coupling hole must be made at joints to facilitate installation of the polyethylene. After completing the joint, overlap the polyethylene over the joint as described in Method A.

(3) Repair any rips, punctures, or other damage to the polyethylene. Confirm and adjust any necessary grade of the piping section. Proceed with installation of the next section of pipe in the same manner.

### **Protection of Fittings:**

*Pipe-Shaped Appurtenances:* Bends, reducers, offsets, and other pipe-shaped appurtenances are covered with polyethylene in the same manner as the pipe.

*Odd-Shaped Appurtenances:* Tees, crosses, and other odd-shaped pieces that cannot be practically wrapped in a tube are covered with a flat sheet or split length of polyethylene tube. Pass the sheet under the appurtenance and bring up around the body. Make seams by bringing the edges together, folding over twice, and taping down (see Fig. 22). Handle slack width and overlaps at joints the same as in pipe installation. Tape the polyethylene securely in place.

*Repairs:* Repair any cuts, tears, punctures, or damage to polyethylene with adhesive tape or with a short length of polyethylene tube cut open, wrapped around the pipe covering the damaged area, and secured in the same manner as used in securing pipe wrap.

*Junctions Between Wrapped and Unwrapped Pipe:* Where polyethylene-wrapped pipe joins a pipe that is not wrapped, extend the polyethylene tube to cover the unwrapped pipe to a distance of at least three feet. Secure the end with circumferential turns of tape.

*Backfill of Polyethylene-Wrapped Pipe:* Backfill procedures are the same as those specified for pipe without polyethylene wrapping. Take special care to prevent damage to the polyethylene wrapping when placing backfill. Backfill material shall be free of cinders, refuse, frozen earth, boulders, rocks, stones, job site debris, or other material that could damage polyethylene.

## INFILTRATION AND EXFILTRATION

The best solution to infiltration and exfiltration is a well-designed, well-constructed, and properly inspected sewer with tight joints and having passed a pressure test. A good community plumbing code, well enforced by municipal authorities is essential.

### *Infiltration*

Infiltration may be defined as water that enters the sanitary sewer system through defective joints, cracked or broken pipes, the walls of manholes, manhole tops, and yard, areaway, and foundation footing drains. Usually the accumulation of ground and surface water accompanying a rainy period can be a factor; infiltration may also take place during dry weather if the sanitary sewer is near a creek bed or spring. In recent years, infiltration has become more important to engineers, health officials, and water-treatment and sewage-treatment plant officials.

Sewage-treatment plants are usually designed for dry-weather flow with a nominal allowance for infiltration during the wet season. This allowance is usually 20 to 25 percent in well-designed systems. Reports indicate that some treatment plants receive 100, 200, and even

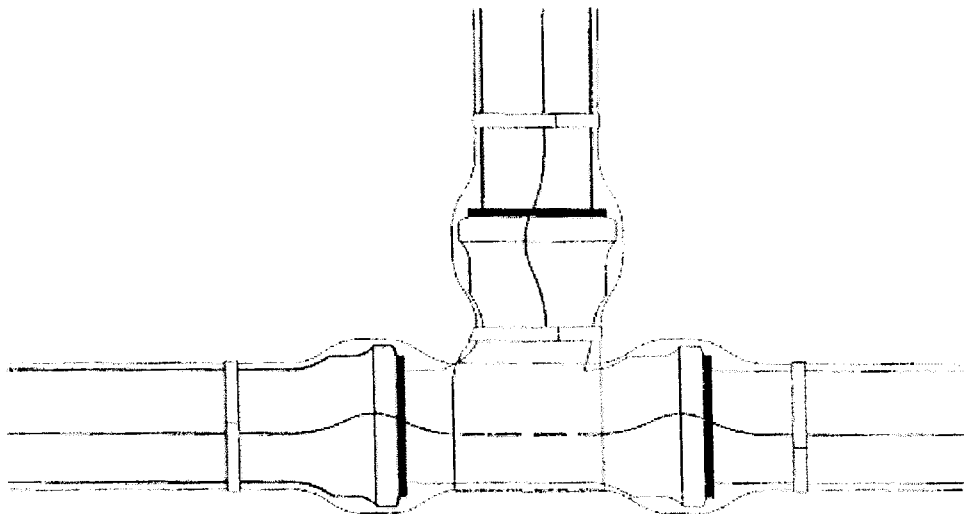

Figure 22—Method “A” Installation on Odd-Shaped Appurtenances.

300 percent of capacity during periods of heavy rain. A report from a county engineer for the State of New York makes the following observations concerning infiltration:

The quantity of ground, storm and surface waters discharging into county trunk sewers from sanitary lateral connections is highly excessive, resulting in overloading the trunk sewers, pumping stations and treatment plants, and increasing treatment and maintenance costs. This situation has resulted in the flooding of buildings and homes caused by surcharged sewers and in pollution of adjacent streams, potable waters and bathing areas. Unless this condition is alleviated, the ultimate capacity of the trunk sewers will be reached many years before the date contemplated by the sewer design, and the time will be brought nearer when the costly job of constructing additional facilities must be undertaken. The county is undertaking the preparation of construction standards, aimed to prevent leakage in sewers, for presentation to the contributing municipalities for their consideration.

It is evident that that the greatest amount of infiltration originates from residential sewer connections. This is indicated by the following excerpt from *Public Works* magazine:

Infiltration has been with us almost since the first pipes were laid, but with the increasing provision of treatment plants, the problem becomes more serious and costly. There is practically no way to cure it if it occurs. Careful specifications, the use of the best materials and rigid inspection during construction are the only preventatives. In many cases, the major part of infiltration enters through the house connections, emphasizing the need for our preventative factors of specifications, good materials and strict inspection in their construction. *In one study it was estimated that house connection infiltration represented about 80% of the total* (emphasis added). It should be remembered that in a residential area, the footage of house sewers may be twice as great as the footage of laterals.<sup>1</sup>

One of the main steps that can be taken to reduce the amount of infiltration is to install cast iron soil pipe and fittings. Another measure that has been adopted by many cities to reduce infiltration is to require a 10-foot head of water test on all sewers. A ten-foot head is equal to 4.34 pounds per square inch of pressure.

### ***Exfiltration***

During dry seasons, a sewer that leaks may allow sewage to flow out into the soil and find its way into underground streams, thereby contaminating groundwater. This is termed "exfiltration." A watertight sewer line is essential to eliminate this condition. Cast iron soil pipe systems are watertight and durable, and assure adequate protection against exfiltration.

In May 1980 an infiltration test was conducted by the Cast Iron Soil Pipe Institute and witnessed by an independent testing laboratory. The test was conducted to determine the effect of infiltration of water through **☿** NO-HUB® soil pipe and no-hub couplings. The no-hub couplings used in this test were of a design to which the Institute previously held patent rights. The testing procedure involved connecting 4-, 6-, 8- and 10-inch size reducers with hubless couplings and measuring the amount of water seepage into the interior cavity of the soil pipe system when water pressure was placed on the exterior of the system. A pressure of 50 PSI was exerted on the system for 30 minutes, and no leakage was found. The pressure was then reduced to 20 PSI, and allowed to remain for 24 hours. Still no leakage was found.

<sup>1</sup> "Infiltration Into Sewers Can Cost Lots of Money," *Public Works*, August, 1958.

# CHAPTER V

## TRENCHING RECOMMENDATIONS FOR CAST IRON SOIL PIPE

“That out of sight is out of mind  
Is true of most we leave behind.”

*Songs in Absence*  
Arthur Hugh Clough  
1819–1861

The installation of an underground piping material truly is a job that the designer or engineer wants to do only once for the planned life of the building or structure. With an understanding of the factors involved in the underground installation of the piping material, this can be accomplished.

An underground piping material can be subjected to combined internal and external loads; however, because cast iron soil pipe and fittings are used in non-pressure applications, we will be concerned only with external loads.

*External loads* on underground pipe are made up of the weight of the backfill, which is called *earth load*, and the weight of traffic plus impact, which is called *truck load*. Both these loads combine to equal the *total load* on the underground pipe.

The effect of these external loads can be reduced by proper installation. Tests performed at the University of Iowa for the American Standards Association A-21 Committee established the basic formulas that are used in our calculations.

The ability of a cast iron pipe to withstand external loads is determined by *ring crushing tests*. To determine the ring crush load a cast iron pipe will withstand before failure, random samples of cast iron soil pipe were subjected to a *three-edge bearing crushing test*. These pipe samples were placed in a compression testing machine and loaded until failure occurred. Hundreds of samples were tested in obtaining the values to be used for design purposes. These values are referred to as the *modulus of rupture*, which is 45,000 PSI for Cast Iron Soil Pipe.

To determine the ring crushing load for the various sizes of pipe once the modulus of rupture is determined, a three-edge bearing formula is used:

$$W = \frac{t^2 R}{.0795 (D_m)}$$

W = three-edge bearing ring crushing load (lbs./linear ft.)

t = nominal thickness of the pipe (in.)

D<sub>m</sub> = mean diameter (inch) (O.D. – thickness)

R = modulus of rupture (45,000 PSI)

By using this formula, the ring crushing load for pipe can be calculated. This load can be found in Table 1.

External loads are calculated using two formulas. One formula is used to calculate earth load and one to calculate truck load.

The tables reflect the calculated values of the earth loads using the A 21.1 formulas. These calculated values are found in Table 2 as (EL).

The calculation of truck loads is based on two passing trucks with a wheel load of 16,000 pounds plus an impact factor on an unpaved surface or flexible pavement. These calculated values are found in Table 2 as (TL).

The effect of external loads on the buried pipe can be reduced by control of trench width and by support of the pipe in the trench. The laying condition shown in Figure 1 is a flat-bottom trench providing continuous support to the pipe.

The values calculated that appear in the tables are the loads in pounds per linear foot that the pipe will experience at the depth indicated. It should be noted that none of the loads in Table 2 reach or exceed the crushing loads shown in Table 1.

## HOW TO USE THE TABLES

Determine size and type pipe being considered (service, hubless or extra heavy). From Table 1, find maximum crushing load for pipe being considered. Next, determine depth of cover and trench width (12", 18", 24", 36"). Using Table 2, find total load (L) for pipe size and depth of cover being considered. Total load (L) from Table 2 should not exceed maximum crushing load from Table 1.

### Example

10" Hubless Pipe is being buried in a 24" wide trench 6'0" deep. Total load (L) is 1336 pounds per linear foot and the ring-crushing load for 10" Hubless Pipe is 4317 pounds per linear foot.

**TABLE 1**  
**Ring Test Crushing Loads on Cast Iron Soil Pipe**

Hubless				Service Weight				Extra Heavy			
Pipe Size	Nominal O.D.	Nominal Thickness	Maximum Crushing Load*	Pipe Size	Nominal O.D.	Nominal Thickness	Maximum Crushing Load*	Pipe Size	Nominal O.D.	Nominal Thickness	Maximum Crushing Load*
In.	In.	In.	lbs / ft	In.	In.	In.	lbs / ft	In.	In.	In.	lbs. / ft.
1.5	1.90	0.16	8328								
2	2.35	0.16	6617	2	2.30	0.17	7680	2	2.38	0.19	9331
3	3.35	0.16	4542	3	3.30	0.17	5226	3	3.50	0.25	10885
4	4.38	0.19	4877	4	4.30	0.18	4451	4	4.50	0.25	8324
5	5.30	0.19	3999	5	5.30	0.18	3582	5	5.50	0.25	6739
6	6.30	0.19	3344	6	6.30	0.18	2997	6	6.50	0.25	5660
8	8.38	0.23	3674	8	8.38	0.23	3674	8	8.62	0.31	6546
10	10.56	0.28	4317	10	10.50	0.28	4342	10	10.75	0.37	7465
				12	12.50	0.28	3632	12	12.75	0.37	6259
				15	15.88	0.36	4727	15	15.88	0.44	7097

\* Pounds per linear ft.

Maximum crushing load is calculated using nominal thickness.

Greater or lesser thickness will affect maximum crushing load.

## BURIAL OF CAST IRON SOIL PIPE AND FITTINGS

The underground burial of cast iron soil pipe and fittings is often regarded as a simple task. One of the basic reasons is cast iron's inherent strength. By following certain elementary requirements a trouble free installation can be accomplished.

### *Handling*

Although cast iron is strong, reasonable care should be taken in handling the pipe and fittings prior to installation. From the time the pipe is taken from the casting machine until it is unloaded at the jobsite, the manufacturers exercise care to avoid damage to the product. In unloading, the pipe should not be dropped or allowed to roll into other pipe or fittings.

### *Excavation*

The width of the trench for the various sizes of pipe is determined by the type of soil, the depth of the trench, and the excavation equipment used. Generally speaking, the wider the trench, the greater the earth load on the pipe. The bottom of the trench should be excavated true and even so that the barrel of the pipe will have full support along its entire length. Hub holes or coupling holes should be large enough to allow assembly of the joints but not so large that the pipe is not uniformly supported.

In rock excavation, the rock should be removed and a bed of sand or selected backfill, at least six inches deep, should be placed on the bottom of the trench to "cushion" the pipe. This protects the pipe from sharp projections of rock or uneven bedding.

There are several recognized types of trench bottoms for the installation of cast iron soil pipe. Figure 1 illustrates a type 1 trench installation with a flat-bottom trench and hub or coupling holes. By improving on this installation with tamped backfill, the bearing strength of the pipe increases.

Additional information on specific questions related to underground installations can be addressed to the Cast Iron Soil Pipe Institute or its member companies.

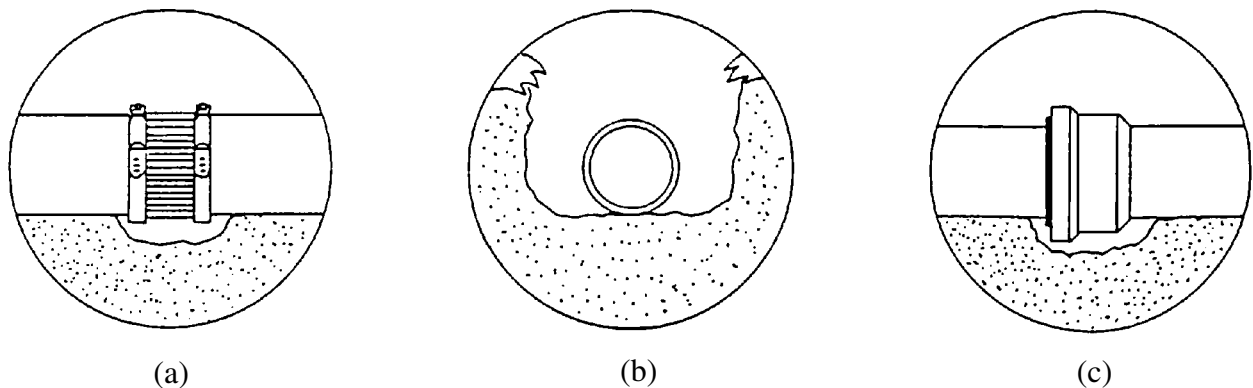

Figure 1—Type 1 Trench Condition, No Pipe Bedding and Hard Trench Bottom: (a) Coupling Holes; (b) Continuous Line Support; (c) Continuous Line Support With Hub.

TABLE 2

PIPE SIZE		1½"			2"			3"			4"			5"		
Depth of Cover	Trench Width	12"	18"	24"	12"	18"	24"	12"	18"	24"	12"	18"	24"	18"	24"	36"
		2.0'	EL	57	57	57	75	75	75	111	111	111	144	144	144	177
	TL	<u>77</u>	<u>77</u>	<u>77</u>	<u>192</u>	<u>192</u>	<u>192</u>	<u>365</u>	<u>365</u>	<u>365</u>	<u>614</u>	<u>614</u>	<u>614</u>	<u>864</u>	<u>864</u>	<u>864</u>
	L	134	134	134	267	267	267	476	476	476	758	758	758	1041	1041	1041
2.5'	EL	72	72	72	95	95	95	140	140	140	184	184	184	226	226	226
	TL	<u>44</u>	<u>44</u>	<u>44</u>	<u>141</u>	<u>141</u>	<u>141</u>	<u>211</u>	<u>211</u>	<u>211</u>	<u>387</u>	<u>387</u>	<u>387</u>	<u>563</u>	<u>563</u>	<u>563</u>
	L	116	116	116	236	236	236	351	351	351	571	571	571	789	789	789
3.0'	EL	86	86	86	115	115	115	169	169	169	223	223	223	250	275	275
	TL	<u>35</u>	<u>35</u>	<u>35</u>	<u>106</u>	<u>106</u>	<u>106</u>	<u>141</u>	<u>141</u>	<u>141</u>	<u>282</u>	<u>282</u>	<u>282</u>	<u>422</u>	<u>422</u>	<u>422</u>
	L	121	121	121	221	221	221	310	310	310	505	505	505	672	697	697
3.5'	EL	101	101	101	134	134	134	199	199	199	262	262	262	276	324	324
	TL	<u>26</u>	<u>26</u>	<u>26</u>	<u>67</u>	<u>67</u>	<u>67</u>	<u>96</u>	<u>96</u>	<u>96</u>	<u>192</u>	<u>192</u>	<u>192</u>	<u>288</u>	<u>288</u>	<u>288</u>
	L	127	127	127	201	201	201	295	295	295	454	454	454	564	612	612
4.0'	EL	116	116	116	154	154	154	228	228	228	298	301	301	373	373	373
	TL	<u>21</u>	<u>21</u>	<u>21</u>	<u>48</u>	<u>48</u>	<u>48</u>	<u>80</u>	<u>80</u>	<u>80</u>	<u>144</u>	<u>144</u>	<u>144</u>	<u>232</u>	<u>232</u>	<u>232</u>
	L	137	137	137	202	202	202	308	308	308	442	445	445	605	605	605
4.5'	EL	131	131	131	173	173	173	258	258	258	318	341	341	422	422	422
	TL	<u>18</u>	<u>18</u>	<u>18</u>	<u>40</u>	<u>40</u>	<u>40</u>	<u>72</u>	<u>72</u>	<u>72</u>	<u>120</u>	<u>120</u>	<u>120</u>	<u>196</u>	<u>196</u>	<u>196</u>
	L	149	149	149	213	213	213	330	330	330	438	461	461	618	618	618
5.0'	EL	145	145	145	193	193	193	287	287	287	336	380	380	471	471	471
	TL	<u>16</u>	<u>16</u>	<u>16</u>	<u>32</u>	<u>32</u>	<u>32</u>	<u>64</u>	<u>64</u>	<u>64</u>	<u>96</u>	<u>96</u>	<u>96</u>	<u>160</u>	<u>160</u>	<u>160</u>
	L	161	161	161	225	225	225	351	351	351	432	476	476	631	631	631
5.5'	EL	160	160	160	213	213	213	317	317	317	351	419	419	520	520	520
	TL	<u>14</u>	<u>14</u>	<u>14</u>	<u>30</u>	<u>30</u>	<u>30</u>	<u>60</u>	<u>60</u>	<u>60</u>	<u>88</u>	<u>88</u>	<u>88</u>	<u>140</u>	<u>140</u>	<u>140</u>
	L	174	174	174	243	243	243	377	377	377	439	507	507	660	660	660
6.0'	EL	175	175	175	232	232	232	346	346	346	365	458	458	569	569	569
	TL	<u>13</u>	<u>13</u>	<u>13</u>	<u>29</u>	<u>29</u>	<u>29</u>	<u>56</u>	<u>56</u>	<u>56</u>	<u>80</u>	<u>80</u>	<u>80</u>	<u>120</u>	<u>120</u>	<u>120</u>
	L	188	188	188	261	261	261	402	402	402	445	539	539	689	689	689
6.5'	EL	189	189	189	252	252	252	375	375	375	376	497	497	618	618	618
	TL	<u>12</u>	<u>12</u>	<u>12</u>	<u>28</u>	<u>28</u>	<u>28</u>	<u>54</u>	<u>54</u>	<u>54</u>	<u>76</u>	<u>76</u>	<u>76</u>	<u>112</u>	<u>112</u>	<u>112</u>
	L	201	201	201	280	280	280	429	429	429	452	573	573	730	730	730
7.0'	EL	204	204	204	271	271	271	387	405	405	387	537	537	667	667	667
	TL	<u>11</u>	<u>11</u>	<u>11</u>	<u>27</u>	<u>27</u>	<u>27</u>	<u>52</u>	<u>52</u>	<u>52</u>	<u>72</u>	<u>72</u>	<u>72</u>	<u>104</u>	<u>104</u>	<u>104</u>
	L	215	215	215	298	298	298	439	457	457	459	609	609	771	771	771
7.5'	EL	219	219	219	291	291	291	396	396	396	396	576	576	716	716	716
	TL	<u>10</u>	<u>10</u>	<u>10</u>	<u>26</u>	<u>26</u>	<u>26</u>	<u>50</u>	<u>50</u>	<u>50</u>	<u>68</u>	<u>68</u>	<u>68</u>	<u>96</u>	<u>96</u>	<u>96</u>
	L	229	229	229	317	317	317	446	446	446	464	644	644	812	812	812
8.0'	EL	234	234	234	311	311	311	404	464	464	404	615	615	765	765	765
	TL	<u>10</u>	<u>10</u>	<u>10</u>	<u>26</u>	<u>26</u>	<u>26</u>	<u>48</u>	<u>48</u>	<u>48</u>	<u>64</u>	<u>64</u>	<u>64</u>	<u>88</u>	<u>88</u>	<u>88</u>
	L	244	244	244	337	337	337	452	512	512	468	679	679	853	853	853

Notes: All O.D.s are based on service weight nominal O.D.s (ASTM A-74).

EL= earth load; TL=truck (live) load; L=total load.



**TABLE 2 (continued)**

PIPE SIZE		6"			8"			10"			12"			15"		
Depth of Cover	Trench Width	18"	24"	36"	18"	24"	36"	18"	24"	36"	18"	24"	36"	18"	24"	36"
		2.0'	EL	207	207	207	264	264	264	304	314	314	304	359	359	304
	TL	<u>1114</u>	<u>1114</u>	<u>1114</u>	<u>1459</u>	<u>1459</u>	<u>1459</u>	<u>1766</u>	<u>1766</u>	<u>1766</u>	<u>2074</u>	<u>2074</u>	<u>2074</u>	<u>2279</u>	<u>2279</u>	<u>2279</u>
	L	1321	1321	1321	1723	1723	1723	2070	2080	2080	2378	2433	2433	2583	2694	2694
2.5'	EL	266	266	266	342	342	342	365	412	412	365	476	476	365	512	560
	TL	<u>739</u>	<u>739</u>	<u>739</u>	<u>1021</u>	<u>1021</u>	<u>1021</u>	<u>1267</u>	<u>1267</u>	<u>1267</u>	<u>1514</u>	<u>1514</u>	<u>1514</u>	<u>1684</u>	<u>1684</u>	<u>1684</u>
	L	1005	1005	1005	1363	1363	1363	1632	1679	1679	1879	1990	1990	2049	2196	2244
3.0'	EL	325	325	325	421	421	421	421	510	510	421	594	594	421	596	707
	TL	<u>563</u>	<u>563</u>	<u>563</u>	<u>774</u>	<u>774</u>	<u>774</u>	<u>986</u>	<u>986</u>	<u>986</u>	<u>1232</u>	<u>1232</u>	<u>1232</u>	<u>1360</u>	<u>1360</u>	<u>1360</u>
	L	888	888	888	1195	1195	1195	1407	1496	1496	1653	1826	1826	1781	1956	2067
3.5'	EL	384	384	384	472	499	499	472	674	609	472	675	712	472	675	854
	TL	<u>384</u>	<u>384</u>	<u>384</u>	<u>576</u>	<u>576</u>	<u>576</u>	<u>736</u>	<u>736</u>	<u>736</u>	<u>896</u>	<u>896</u>	<u>896</u>	<u>1023</u>	<u>1023</u>	<u>1023</u>
	L	768	768	768	1075	1075	1075	1208	1410	1345	1368	1571	1608	1495	1698	1877
4.0'	EL	443	443	443	519	519	578	519	707	707	519	749	829	519	749	1001
	TL	<u>320</u>	<u>320</u>	<u>320</u>	<u>480</u>	<u>480</u>	<u>480</u>	<u>624</u>	<u>624</u>	<u>624</u>	<u>752</u>	<u>752</u>	<u>752</u>	<u>936</u>	<u>936</u>	<u>936</u>
	L	763	763	763	999	999	1058	1143	1331	1331	1271	1501	1581	1455	1685	1937
4.5'	EL	501	501	501	562	656	656	562	805	805	562	818	947	562	818	1149
	TL	<u>272</u>	<u>272</u>	<u>272</u>	<u>416</u>	<u>416</u>	<u>416</u>	<u>536</u>	<u>536</u>	<u>536</u>	<u>648</u>	<u>648</u>	<u>648</u>	<u>812</u>	<u>812</u>	<u>812</u>
	L	773	773	773	978	1072	1072	1098	1341	1341	1210	1466	1595	1374	1630	1961
5.0'	EL	560	560	560	601	735	735	602	882	903	602	882	1065	602	882	1296
	TL	<u>224</u>	<u>224</u>	<u>224</u>	<u>352</u>	<u>352</u>	<u>352</u>	<u>448</u>	<u>448</u>	<u>448</u>	<u>544</u>	<u>544</u>	<u>544</u>	<u>688</u>	<u>688</u>	<u>688</u>
	L	784	784	784	953	1087	1087	1050	1330	1351	1146	1426	1609	1290	1570	1984
5.5'	EL	619	619	619	638	813	813	638	943	1001	638	943	1182	638	943	1443
	TL	<u>192</u>	<u>192</u>	<u>192</u>	<u>312</u>	<u>312</u>	<u>312</u>	<u>392</u>	<u>392</u>	<u>392</u>	<u>488</u>	<u>488</u>	<u>488</u>	<u>612</u>	<u>612</u>	<u>612</u>
	L	811	811	811	950	1125	1125	1030	1335	1393	1126	1431	1970	1250	1555	2055
6.0'	EL	671	678	678	671	891	891	671	1000	1099	671	1000	1300	671	1000	1590
	TL	<u>160</u>	<u>160</u>	<u>160</u>	<u>272</u>	<u>272</u>	<u>272</u>	<u>336</u>	<u>336</u>	<u>336</u>	<u>432</u>	<u>432</u>	<u>432</u>	<u>536</u>	<u>536</u>	<u>536</u>
	L	831	838	838	943	1163	1163	1007	1336	1435	1103	1432	1732	1207	1536	2126
6.5'	EL	702	737	737	702	970	970	702	1053	1197	702	1053	1418	702	1053	1737
	TL	<u>148</u>	<u>148</u>	<u>148</u>	<u>248</u>	<u>248</u>	<u>248</u>	<u>308</u>	<u>308</u>	<u>308</u>	<u>396</u>	<u>396</u>	<u>396</u>	<u>490</u>	<u>490</u>	<u>490</u>
	L	850	885	885	950	1218	1218	1010	1361	1505	1098	1449	1814	1192	1543	2227
7.0'	EL	730	796	796	730	1048	1048	730	1103	1295	730	1103	1535	730	1103	1884
	TL	<u>136</u>	<u>136</u>	<u>136</u>	<u>224</u>	<u>224</u>	<u>224</u>	<u>280</u>	<u>280</u>	<u>280</u>	<u>360</u>	<u>360</u>	<u>360</u>	<u>444</u>	<u>444</u>	<u>444</u>
	L	866	932	932	954	1272	1272	1010	1383	1575	1090	1463	1895	1174	1547	2328
7.5'	EL	755	854	854	755	1127	1127	755	1150	1393	755	1150	1653	755	1150	1985
	TL	<u>124</u>	<u>124</u>	<u>124</u>	<u>200</u>	<u>200</u>	<u>200</u>	<u>252</u>	<u>252</u>	<u>252</u>	<u>324</u>	<u>324</u>	<u>324</u>	<u>398</u>	<u>398</u>	<u>398</u>
	L	879	978	978	955	1327	1327	1007	1402	1645	1079	1474	1977	1153	1548	2383
8.0'	EL	779	913	913	779	1194	1205	779	1194	1491	779	1194	1770	779	1194	2077
	TL	<u>112</u>	<u>112</u>	<u>112</u>	<u>176</u>	<u>176</u>	<u>176</u>	<u>224</u>	<u>224</u>	<u>224</u>	<u>288</u>	<u>288</u>	<u>288</u>	<u>352</u>	<u>352</u>	<u>352</u>
	L	891	1025	1025	955	1370	1381	1003	1418	1715	1067	1482	2058	1131	1546	2429

TABLE 2 (continued)

PIPE SIZE		1½"			2"			3"			4"			5"		
Depth of Cover	Trench Width	12"	18"	24"	12"	18"	24"	12"	18"	24"	12"	18"	24"	18"	24"	36"
		8.5'	EL	248	248	248	330	330	330	411	493	493	411	654	654	800
	TL	<u>9</u>	<u>9</u>	<u>9</u>	<u>25</u>	<u>25</u>	<u>25</u>	<u>46</u>	<u>46</u>	<u>46</u>	<u>62</u>	<u>62</u>	<u>62</u>	<u>85</u>	<u>85</u>	<u>85</u>
	L	287	287	287	355	355	355	457	539	539	473	716	716	885	899	899
9.0'	EL	263	263	263	350	350	350	417	522	522	417	694	694	820	863	863
	TL	<u>9</u>	<u>9</u>	<u>9</u>	<u>24</u>	<u>24</u>	<u>24</u>	<u>44</u>	<u>44</u>	<u>44</u>	<u>60</u>	<u>60</u>	<u>60</u>	<u>82</u>	<u>82</u>	<u>82</u>
	L	272	272	272	374	374	374	461	566	566	477	754	754	902	945	945
9.5'	EL	278	278	278	369	369	369	423	552	552	423	733	733	838	912	912
	TL	<u>8</u>	<u>8</u>	<u>8</u>	<u>23</u>	<u>23</u>	<u>23</u>	<u>42</u>	<u>42</u>	<u>42</u>	<u>58</u>	<u>58</u>	<u>58</u>	<u>79</u>	<u>79</u>	<u>79</u>
	L	286	286	286	392	392	392	465	594	594	481	791	791	917	991	991
10.0'	EL	292	292	292	389	389	389	427	581	581	427	772	772	855	961	961
	TL	<u>8</u>	<u>8</u>	<u>8</u>	<u>22</u>	<u>22</u>	<u>22</u>	<u>40</u>	<u>40</u>	<u>40</u>	<u>56</u>	<u>56</u>	<u>56</u>	<u>76</u>	<u>76</u>	<u>76</u>
	L	300	300	300	411	411	411	467	621	621	483	828	828	931	1037	1037
10.5'	EL	307	307	307	409	409	409	431	611	611	431	811	811	870	1010	1010
	TL	<u>8</u>	<u>8</u>	<u>8</u>	<u>22</u>	<u>22</u>	<u>22</u>	<u>38</u>	<u>38</u>	<u>38</u>	<u>54</u>	<u>54</u>	<u>54</u>	<u>73</u>	<u>73</u>	<u>73</u>
	L	315	315	315	431	431	431	469	649	649	485	865	865	943	1083	1083
11.0'	EL	322	322	322	428	428	428	435	640	640	435	850	850	884	1059	1059
	TL	<u>7</u>	<u>7</u>	<u>7</u>	<u>21</u>	<u>21</u>	<u>21</u>	<u>36</u>	<u>36</u>	<u>36</u>	<u>52</u>	<u>52</u>	<u>52</u>	<u>70</u>	<u>70</u>	<u>70</u>
	L	329	329	329	449	449	449	471	676	676	487	902	902	954	1129	1129
11.5'	EL	337	337	337	438	448	448	438	670	670	438	890	890	897	1108	1108
	TL	<u>7</u>	<u>7</u>	<u>7</u>	<u>20</u>	<u>20</u>	<u>20</u>	<u>34</u>	<u>34</u>	<u>34</u>	<u>50</u>	<u>50</u>	<u>50</u>	<u>67</u>	<u>67</u>	<u>67</u>
	L	344	344	344	458	468	468	472	704	704	488	940	940	964	1175	1175
12.0'	EL	351	351	351	441	468	468	441	699	699	441	909	929	908	1157	1157
	TL	<u>6</u>	<u>6</u>	<u>6</u>	<u>19</u>	<u>19</u>	<u>19</u>	<u>32</u>	<u>32</u>	<u>32</u>	<u>48</u>	<u>48</u>	<u>48</u>	<u>64</u>	<u>64</u>	<u>64</u>
	L	357	357	357	460	487	487	473	731	731	489	957	977	972	1221	1221
12.5'	EL	366	366	366	444	487	487	444	728	728	444	920	968	919	1206	1206
	TL	<u>6</u>	<u>6</u>	<u>6</u>	<u>18</u>	<u>18</u>	<u>18</u>	<u>30</u>	<u>30</u>	<u>30</u>	<u>46</u>	<u>46</u>	<u>46</u>	<u>61</u>	<u>61</u>	<u>61</u>
	L	372	372	372	466	505	505	474	758	758	490	966	1014	980	1267	1267
13.0'	EL	381	381	381	446	507	507	446	758	758	446	929	1007	929	1255	1255
	TL	<u>5</u>	<u>5</u>	<u>5</u>	<u>18</u>	<u>18</u>	<u>18</u>	<u>28</u>	<u>28</u>	<u>28</u>	<u>44</u>	<u>44</u>	<u>44</u>	<u>58</u>	<u>58</u>	<u>58</u>
	L	386	386	386	466	525	525	474	786	786	490	973	1051	987	1313	1313
13.5'	EL	395	395	395	448	526	526	448	787	787	448	938	1046	938	1304	1304
	TL	<u>4</u>	<u>4</u>	<u>4</u>	<u>17</u>	<u>17</u>	<u>17</u>	<u>26</u>	<u>26</u>	<u>26</u>	<u>42</u>	<u>42</u>	<u>42</u>	<u>55</u>	<u>55</u>	<u>55</u>
	L	399	399	399	465	543	543	474	813	813	520	980	1088	993	1359	1359
14.0'	E	410	410	410	449	546	546	449	817	817	449	947	1086	947	1353	1353
	TL	<u>3</u>	<u>3</u>	<u>3</u>	<u>16</u>	<u>16</u>	<u>16</u>	<u>24</u>	<u>24</u>	<u>24</u>	<u>40</u>	<u>40</u>	<u>40</u>	<u>52</u>	<u>52</u>	<u>52</u>
	L	413	413	413	465	562	562	473	841	841	489	987	1126	999	1405	1405
14.5'	E	425	425	425	451	566	566	451	846	846	451	954	1125	954	1402	1402
	TL	<u>2</u>	<u>2</u>	<u>2</u>	<u>15</u>	<u>15</u>	<u>15</u>	<u>22</u>	<u>22</u>	<u>22</u>	<u>38</u>	<u>38</u>	<u>38</u>	<u>49</u>	<u>49</u>	<u>49</u>
	L	427	427	427	466	581	581	473	868	868	489	992	1163	1003	1451	1451

**TABLE 2 (continued)**

PIPE SIZE		6"			8"			10"			12"			15"		
Depth of Cover	Trench Width	6"			8"			10"			12"			15"		
		18"	24"	36"	18"	24"	36"	18"	24"	36"	18"	24"	36"	18"	24"	36"
8.5'	EL	801	972	972	801	1235	1284	801	1235	1589	801	1235	1888	801	1235	2165
	TL	108	108	108	168	168	168	212	212	212	264	264	264	324	324	324
	L	909	1080	1080	969	1403	1452	1013	1447	1801	1065	1529	2152	1125	1559	2489
9.0'	EL	820	1031	1031	820	1273	1362	820	1273	1687	820	1273	2006	821	1273	2250
	TL	104	104	104	160	160	160	200	200	200	240	240	240	296	296	296
	L	924	1135	1135	980	1433	1522	1020	1473	1887	1060	1513	2246	1117	1569	2546
9.5'	EL	838	1090	1090	838	1309	1441	838	1309	1785	838	1309	2123	838	1309	2330
	TL	100	100	100	152	152	152	188	188	188	216	216	216	268	268	268
	L	938	1190	1190	990	1461	1593	1026	1497	1973	1054	1525	2339	1106	1577	2598
10.0'	EL	855	1149	1149	855	1343	1519	855	1343	1883	855	1343	2241	855	1343	2407
	TL	96	96	96	144	144	144	176	176	176	192	192	192	240	240	240
	L	951	1245	1245	999	1487	1663	1031	1519	2059	1047	1535	2433	1095	1583	2647
10.5'	EL	870	1207	1207	870	1374	1597	870	1374	1981	870	1374	2359	870	1374	2481
	TL	92	92	92	136	136	136	164	164	164	180	180	180	224	224	224
	L	962	1299	1299	1006	1500	1733	1034	1538	2145	1050	1554	2539	1094	1598	2705
11.0'	EL	884	1266	1266	884	1404	1676	884	1404	2079	884	1404	2476	884	1404	2552
	TL	88	88	88	128	128	128	152	152	152	168	168	168	208	208	208
	L	972	1354	1354	1012	1532	1804	1036	1556	2231	1052	1572	2644	1092	1612	2760
11.5'	EL	897	1325	1325	897	1432	1754	897	1432	2177	897	1432	2594	897	1432	2620
	TL	84	84	84	120	120	120	140	140	140	156	156	156	192	192	192
	L	981	1409	1409	1017	1552	1874	1037	1572	2317	1053	1588	2750	1089	1624	2812
12.0'	EL	908	1384	1384	908	1458	1833	908	1458	2275	908	1458	2685	908	1458	2685
	TL	80	80	80	112	112	112	128	128	128	144	144	144	176	176	176
	L	988	1464	1464	1020	1570	1945	1036	1586	2403	1052	1602	2829	1084	1634	2861
12.5'	EL	919	1443	1443	919	1482	1911	919	1482	2373	919	1482	2747	919	1482	2747
	TL	76	76	76	106	106	106	122	122	122	138	138	138	170	170	170
	L	995	1519	1519	1025	1588	2017	1041	1604	2495	1057	1620	2885	1089	1652	2917
13.0'	EL	929	1502	1502	929	1505	1990	929	1505	2471	929	1505	2807	929	1505	2807
	TL	72	72	72	100	100	100	116	116	116	132	132	132	164	164	164
	L	1001	1574	1574	1029	1605	2090	1045	1621	2587	1061	1637	2939	1093	1679	2971
13.5'	EL	938	1526	1560	938	1526	2068	938	1526	2570	938	1526	2864	938	1526	2864
	TL	68	68	68	94	94	94	110	110	110	126	126	126	158	158	158
	L	1006	1594	1628	1032	1620	2162	1048	1636	2680	1064	1652	2990	1096	1684	3022
14.0'	EL	947	1547	1619	947	1547	2147	947	1547	2668	947	1547	2919	947	1547	2919
	TL	64	64	64	88	88	88	104	104	104	120	120	120	152	152	152
	L	1011	1611	1683	1035	1635	2235	1051	1651	2772	1067	1667	3039	1099	1699	3071
14.5'	EL	954	1566	1678	954	1566	2225	954	1566	2766	954	1566	2972	954	1566	2972
	TL	60	60	60	82	82	82	98	98	98	114	114	114	146	146	146
	L	1014	1626	1738	1036	1648	2307	1052	1664	2864	1068	1684	3086	1100	1712	3118

TABLE 2 (continued)

PIPE SIZE		1½"			2"			3"			4"			5"		
Depth of Cover	Trench Width	12"	18"	24"	12"	18"	24"	12"	18"	24"	12"	18"	24"	18"	24"	36"
		15.0'	EL	439	439	439	452	585	585	452	875	875	452	961	1164	961
	TL	<u>2</u>	<u>2</u>	<u>2</u>	<u>14</u>	<u>14</u>	<u>14</u>	<u>20</u>	<u>20</u>	<u>20</u>	<u>36</u>	<u>36</u>	<u>36</u>	<u>46</u>	<u>46</u>	<u>46</u>
	L	441	441	441	466	599	599	472	895	895	488	997	1200	1007	1497	1497
15.5'	EL	453	454	454	453	605	605	453	905	905	453	968	1203	968	1500	1500
	TL	<u>1</u>	<u>1</u>	<u>1</u>	<u>14</u>	<u>14</u>	<u>14</u>	<u>18</u>	<u>18</u>	<u>18</u>	<u>34</u>	<u>34</u>	<u>34</u>	<u>43</u>	<u>43</u>	<u>43</u>
	L	454	455	455	467	619	619	471	923	923	487	1002	1237	1011	1543	1543
16.0'	EL	454	469	469	454	624	624	454	934	934	454	974	1243	974	1549	1549
	TL	<u>0</u>	<u>0</u>	<u>0</u>	<u>13</u>	<u>13</u>	<u>13</u>	<u>16</u>	<u>16</u>	<u>16</u>	<u>32</u>	<u>32</u>	<u>32</u>	<u>40</u>	<u>40</u>	<u>40</u>
	L	454	469	469	467	637	637	470	950	950	486	1006	1275	1014	1589	1589
16.5'	EL	455	484	484	455	644	644	455	964	964	455	979	1282	979	1598	1598
	TL	<u>*</u>	<u>*</u>	<u>*</u>	<u>*</u>	<u>*</u>	<u>*</u>	<u>*</u>	<u>*</u>	<u>*</u>	<u>*</u>	<u>*</u>	<u>*</u>	<u>*</u>	<u>*</u>	<u>*</u>
	L	455	484	484	455	644	644	455	964	964	455	979	1282	979	1598	1598
17.0'	EL	456	498	498	456	644	644	456	984	993	456	984	1321	984	1644	1647
	TL	<u>*</u>	<u>*</u>	<u>*</u>	<u>*</u>	<u>*</u>	<u>*</u>	<u>*</u>	<u>*</u>	<u>*</u>	<u>*</u>	<u>*</u>	<u>*</u>	<u>*</u>	<u>*</u>	<u>*</u>
	L	456	498	498	456	644	644	456	984	993	456	984	1321	984	1644	1647
17.5'	EL	457	513	513	457	683	683	457	989	1023	457	988	1360	989	1656	1692
	TL	<u>*</u>	<u>*</u>	<u>*</u>	<u>*</u>	<u>*</u>	<u>*</u>	<u>*</u>	<u>*</u>	<u>*</u>	<u>*</u>	<u>*</u>	<u>*</u>	<u>*</u>	<u>*</u>	<u>*</u>
	L	457	513	513	457	683	683	457	989	1023	457	988	1360	989	1656	1692
18.0'	EL	457	528	528	457	703	703	457	993	1052	457	993	1399	993	1668	1745
	TL	<u>*</u>	<u>*</u>	<u>*</u>	<u>*</u>	<u>*</u>	<u>*</u>	<u>*</u>	<u>*</u>	<u>*</u>	<u>*</u>	<u>*</u>	<u>*</u>	<u>*</u>	<u>*</u>	<u>*</u>
	L	457	528	528	457	703	703	457	993	1052	457	993	1399	993	1668	1745
18.5'	EL	458	542	542	458	722	722	458	996	1081	458	996	1439	996	1680	1794
	TL	<u>*</u>	<u>*</u>	<u>*</u>	<u>*</u>	<u>*</u>	<u>*</u>	<u>*</u>	<u>*</u>	<u>*</u>	<u>*</u>	<u>*</u>	<u>*</u>	<u>*</u>	<u>*</u>	<u>*</u>
	L	458	542	542	458	722	722	458	996	1081	458	996	1439	996	1680	1794
19.0'	EL	458	557	557	458	742	742	458	1000	1111	458	1000	1478	1000	1690	1843
	TL	<u>*</u>	<u>*</u>	<u>*</u>	<u>*</u>	<u>*</u>	<u>*</u>	<u>*</u>	<u>*</u>	<u>*</u>	<u>*</u>	<u>*</u>	<u>*</u>	<u>*</u>	<u>*</u>	<u>*</u>
	L	458	557	557	458	742	742	458	1000	1111	458	1000	1478	1000	1690	1843
19.5'	EL	459	572	572	459	762	762	459	1003	1140	459	1003	1517	1003	1700	1893
	TL	<u>*</u>	<u>*</u>	<u>*</u>	<u>*</u>	<u>*</u>	<u>*</u>	<u>*</u>	<u>*</u>	<u>*</u>	<u>*</u>	<u>*</u>	<u>*</u>	<u>*</u>	<u>*</u>	<u>*</u>
	L	459	572	572	459	762	762	459	1003	1140	459	1003	1517	1003	1700	1893
20.0'	EL	459	587	587	459	781	781	459	1006	1170	459	1006	1556	1006	1709	1942
	TL	<u>*</u>	<u>*</u>	<u>*</u>	<u>*</u>	<u>*</u>	<u>*</u>	<u>*</u>	<u>*</u>	<u>*</u>	<u>*</u>	<u>*</u>	<u>*</u>	<u>*</u>	<u>*</u>	<u>*</u>
	L	459	587	587	459	781	781	459	1006	1170	459	1006	1556	1006	1709	1942

**TABLE 2 (continued)**

PIPE SIZE		1½"			2"			3"			4"			5"		
Depth of Cover	Trench Width	18"	24"	36"	18"	24"	36"	18"	24"	36"	18"	24"	36"	18"	24"	36"
		15.0'	EL	961	1584	1737	961	1584	2303	961	1584	2864	961	1584	3022	961
	TL	<u>56</u>	<u>56</u>	<u>56</u>	<u>76</u>	<u>76</u>	<u>76</u>	<u>92</u>	<u>92</u>	<u>92</u>	<u>108</u>	<u>108</u>	<u>108</u>	<u>140</u>	<u>140</u>	<u>140</u>
	L	1017	1640	1793	1037	1660	2379	1053	1676	2956	1069	1692	3130	1101	1724	3162
15.5'	EL	968	1600	1796	968	1600	2382	968	1600	2962	968	1600	3070	968	1600	3070
	TL	<u>52</u>	<u>52</u>	<u>52</u>	<u>70</u>	<u>70</u>	<u>70</u>	<u>86</u>	<u>86</u>	<u>86</u>	<u>102</u>	<u>102</u>	<u>102</u>	<u>134</u>	<u>134</u>	<u>134</u>
	L	1020	1652	1848	1038	1670	2452	1054	1686	3048	1070	1702	3172	2102	1734	3204
16.0'	EL	974	1616	1855	974	1616	2460	974	1616	3060	974	1616	3116	974	1616	3116
	TL	<u>48</u>	<u>48</u>	<u>48</u>	<u>64</u>	<u>64</u>	<u>64</u>	<u>80</u>	<u>80</u>	<u>80</u>	<u>96</u>	<u>96</u>	<u>96</u>	<u>128</u>	<u>128</u>	<u>128</u>
	L	1022	1664	1903	1038	1680	2524	1054	1696	3140	1070	1712	3212	1102	1744	3244
16.5'	EL	979	1630	1913	979	1630	2539	979	1630	3158	979	1630	3159	979	1630	3160
	TL	*	*	*	*	*	*	*	*	*	*	*	*	*	*	*
	L	979	1630	1913	979	1630	2539	979	1630	3158	979	1630	3159	979	1630	3160
17.0'	EL	984	1644	1972	984	1644	2617	984	1644	3202	984	1644	3202	984	1644	3202
	TL	*	*	*	*	*	*	*	*	*	*	*	*	*	*	*
	L	984	1644	1972	984	1644	2617	984	1644	3202	984	1644	3202	984	1644	3202
17.5'	EL	989	1656	2031	989	1656	2696	989	1656	3242	989	1656	3242	989	1656	3242
	TL	*	*	*	*	*	*	*	*	*	*	*	*	*	*	*
	L	989	1656	2031	989	1656	2696	989	1656	3242	989	1656	3242	989	1656	3242
18.0'	EL	993	1668	2090	993	1668	2774	993	1668	3281	993	1668	3281	993	1668	3281
	TL	*	*	*	*	*	*	*	*	*	*	*	*	*	*	*
	L	993	1668	2090	993	1668	2774	993	1668	3281	993	1668	3281	993	1668	3281
18.5'	EL	996	1680	2149	996	1680	2852	996	1680	3318	996	1680	3318	996	1680	3318
	TL	*	*	*	*	*	*	*	*	*	*	*	*	*	*	*
	L	996	1680	2149	996	1680	2852	996	1680	3318	996	1680	3318	996	1680	3318
19.0'	EL	1000	1690	1843	1000	1690	2931	1000	1690	3353	1000	1690	3353	1000	1690	3353
	TL	*	*	*	*	*	*	*	*	*	*	*	*	*	*	*
	L	1000	1690	1843	1000	1690	2931	1000	1690	3353	1000	1690	3353	1000	1690	3353
19.5'	EL	1003	1700	2266	1003	1700	3009	1003	1700	3387	1003	1700	3387	1003	1700	3387
	TL	*	*	*	*	*	*	*	*	*	*	*	*	*	*	*
	L	1003	1700	2266	1003	1700	3009	1003	1700	3387	1003	1700	3387	1003	1700	3387
20.0'	EL	1006	1709	2325	1006	1709	3088	1006	1709	3419	1006	1709	3419	1006	1709	3419
	TL	*	*	*	*	*	*	*	*	*	*	*	*	*	*	*
	L	1006	1709	2325	1006	1709	3088	1006	1709	3419	1006	1709	3419	1006	1709	3419

## WHY SELECT CAST IRON FOR YOUR UNDERGROUND INSTALLATION?

### *Strength, Durability*

To be of true value, piping materials need to withstand the abuse of installation and endure a lifetime of service. The strength, toughness, and longevity record of cast iron is clearly established.

### *No Infiltration or Exfiltration*

By using compression gaskets or hubless couplings, infiltration and exfiltration at the joints is eliminated.

### *Ease of Installation*

Cast iron is easily installed using hubless and compression joints with neoprene gaskets. Because of the inherent strength of cast iron, special bedding necessary with other materials is not required.

### *Design Compatibility*

Cast iron is easily modified to fit the requirements of the installation. Because of the wide variety of pipe lengths and types and variety of fittings, the material adapts well to changing installation requirements.

### *Meets Codes*

All piping materials must meet local, state, and national codes. Because of cast iron's long history it preceded many of the codes and today is the basis on which most codes are written.

### *Availability*

Cast Iron Soil Pipe and Fittings are produced at member plants geographically located within a two-day shipment range of most jobsites. The product is stocked locally at plumbing and utility supply companies for local pickups.

## Cast Iron

**The Industry Standard because of superior sound containment, corrosion resistance, strength, durability, design compatibility, and ease of installation. And of equal importance, cast iron soil pipe is nonflammable, nontoxic and meets all codes.**

# CHAPTER VI

## UNDERGROUND INSTALLATION COMPARISON: FLEXIBLE VS. RIGID

### UNDERGROUND SEWERS ... ARE THEY INSPECTED CORRECTLY?

Proper underground installation is one of the most costly and misunderstood piping activities. A pipe underground is expected to support the earth load and expected live and traffic loads while limiting deflection so that obstructions and joint leaks are not caused.

A great number of installation specifications and types of pipe are being used, so the inspections to assure proper compliance have become increasingly complicated.

Pipes for underground sewer construction are generally classified in two ways. One is rigid (which includes cast iron, concrete, and vitrified clay). The second classification is flexible (which includes PVC, ABS, steel and ductile iron).

As the names suggest, rigid types are expected to support the anticipated earth and live loads with little or no deflection. This type depends on strength, rigidity, and stiffness to maintain its structural strength. The flexible type is designed to use the side-fill stiffness of trench construction to limit the outward deflection as earth and live loads are exerted on the top of the pipe. (See Figure 1.)

The installation of the two classes of pipe are different. Listed below are the major differences in the installation of cast iron soil pipe and thermoplastic pipe for sewers. For comparison, we used ASTM D2321 (Standard Practice for Underground Installation of Thermoplastic Pipe for Sewers and Other Gravity-Flow Applications) for installation requirements for thermoplastic sewer pipe.

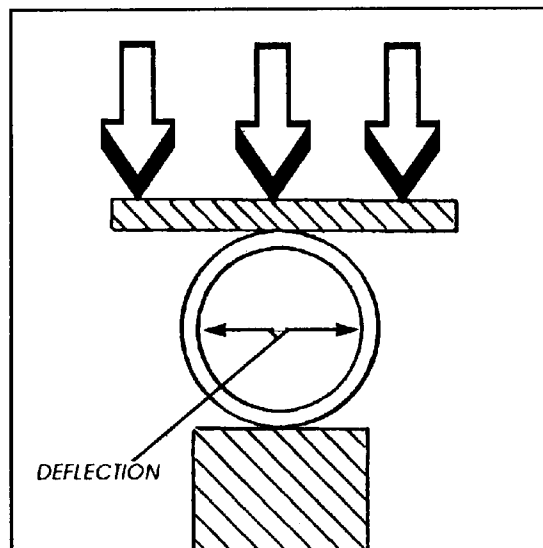

Figure 1—Deflection in Thermoplastic Pipe: Deflection Limit Is Five Percent of O.D.  
Any Deflection in Excess of Five Percent Is Considered Failure.

## TRENCH WIDTH

### *Cast Iron Soil Pipe*

This rigid material does not depend on sidefill stiffness, so the trench can be as narrow as the installer needs to make joint connections. (See Figure 2.)

### **Thermoplastic Sewer Pipe**

As a flexible material, it is dependent on sidefill stiffness to limit deflections. ASTM D2321 recommends a trench width of the pipe outside diameter plus 16 inches or pipe outside diameter times 1.25 plus 12 inches. (Example: a 6" (6.625 O.D.) pipe needs a 20"-wide trench; see Figure 3.)

The reason for the increased width is to allow compaction equipment to operate in the spaces between the trench walls and the pipe. This additional compaction is required to enhance the flexible material's sidewall stiffness.

**CAST IRON SOIL PIPE**

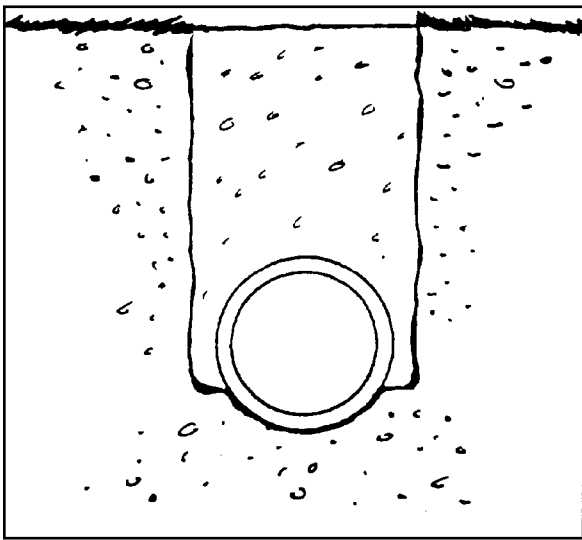

Figure 2—No Special Requirements for Trench Width Needed.

**THERMOPLASTIC PIPE**

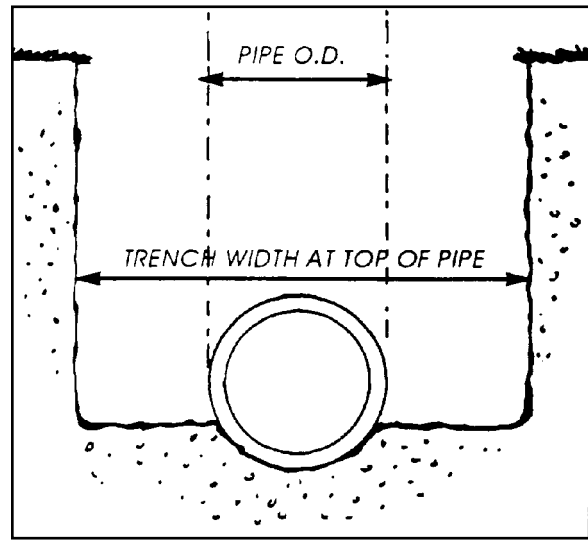

Figure 3—Special Requirements, Trench Width Must be 1.25 x O.D. of Pipe Plus 12 Inches.

## TRENCH BOTTOM

The bottom of the excavated trench must be firm, even, and stable to provide uniform support.

### *Cast Iron Soil Pipe*

The trench bottom must be flat with hub or coupling holes provided so the pipe is uniformly supported. No special bedding is necessary unless the pipe is installed in rock, as illustrated in Figure 4. (In rock excavations, a six-inch bed of sand or other backfill is suggested to protect the pipe from sharp projections.)



**Thermoplastic Sewer Pipe**

The trench bottom must be provided with a minimum of four inches of bedding unless otherwise specified. The bedding material varies by soil type. ASTM D-2321 provides a classification chart for determining the type bedding for varying conditions. In rock excavations, a minimum cushion of six inches is required below the bottom of the pipe. (See Figure 5.)

**COMPACTION OF BACKFILL**

*Cast Iron Soil Pipe*

Special compaction of the backfill is not necessary except for meeting the requirements of normal compaction of the excavated area. Because cast iron is rigid, it does not depend on sidefill support.

*Thermoplastic Sewer Pipe*

The flexible pipe design is dependent on sidefill support to gain stiffness to control deflections within acceptable limits. Compaction in six-inch maximum layers is required to the springline of the pipe. Compaction around the pipe must be done by hand. As noted earlier, trench width must be sufficient to allow this compaction. Depending on soil type, minimum density compaction can range from 85 to 95 percent. (See Figure 6.) If the installation does not have suitable backfill material available, it must be imported.

**CAST IRON SOIL PIPE**

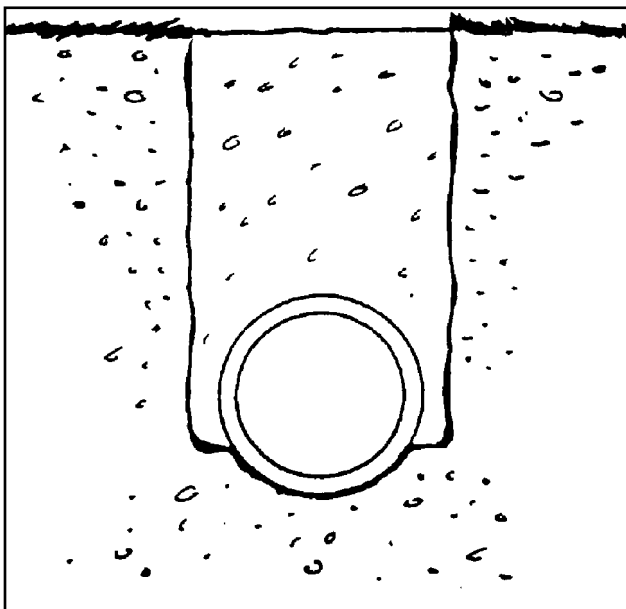

Figure 4—No Special Bedding Required Unless Installations Are in Rock.

**THERMOPLASTIC PIPE**

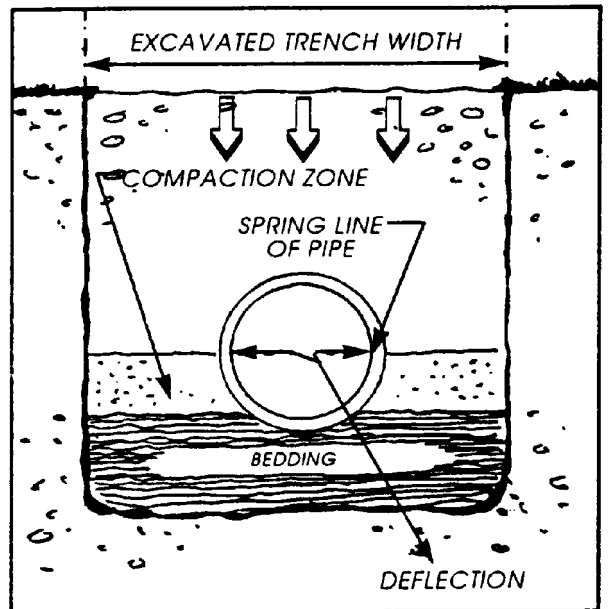

Figure 5—Special Bedding Requirements Per ASTM D 2321.

## DEFLECTION

Deflection in all piping materials must be controlled in order to prevent obstruction of flow and assure that the joints remain secure. (See Figure 7.)

### *Cast Iron Soil Pipe*

Because cast iron is rigid, deflection of the pipe wall is almost nonexistent.

### *Thermoplastic Sewer Pipe*

A flexible pipe is dependent on sidefill support to gain stiffness and some deflection of the pipe wall is both normal and expected. This deflection must be controlled within predetermined limits to assure clearance for inspection, cleaning, meeting flow requirements, and integrity of joint seals. The amount of allowed deflection must be determined before installation, with a maximum of five percent deflection allowed.

Lack of adequate backfill compaction to the springline of the pipe can result in excessive deflection, because this compaction must help support vertical loads on the pipe. There are varied specifications for thermoplastic sewer materials, all of which have a 5 percent deflection limit during test of pipe stiffness.

After selecting piping material, the applicable specification should be reviewed to determine allowed deflection with appropriate safety factors. It is important to monitor the deflection both during and after installation

**THERMOPLASTIC PIPE**

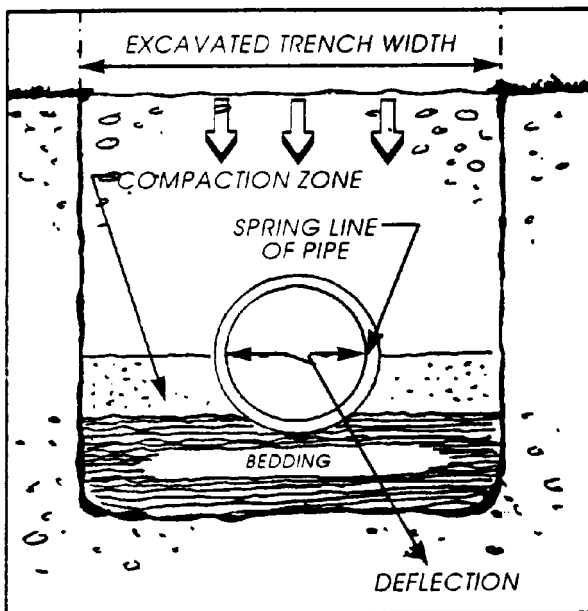

Figure 6—Special Bedding Requirements  
Per ASTM D 2321.

**DEFLECTION IN THERMOPLASTIC PIPE**

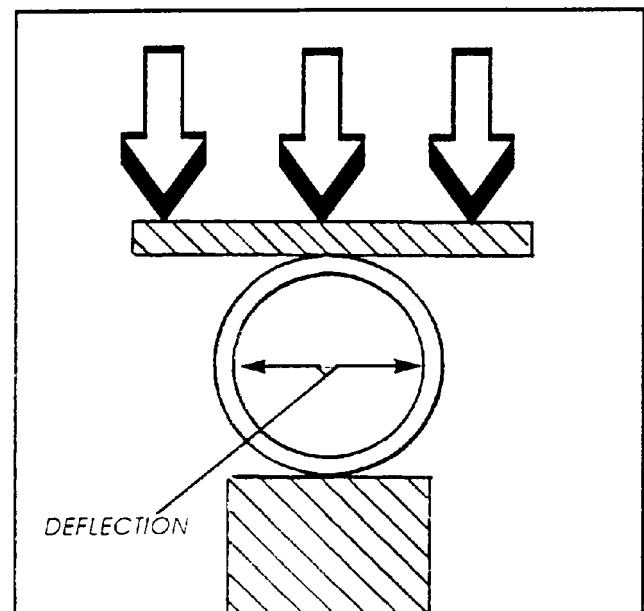

Figure 7—Deflection Limit Is 5 Percent of O.D.  
Any Deflection in Excess Is Considered Failure.

## DETERMINATION OF EXPECTED LOADS AND CRUSH VALUES

To select any piping material, begin by determining probable earth loads and live loads that can be expected to be exerted on the installed pipe. Then compare these loads to the crush resistance of rigid-type pipe such as cast iron, or compare these loads to the maximum allowable deflection of a flexible type pipe such as PVC.

### *Cast Iron Soil Pipe*

Cast iron pipe has known crush strength. Earth loads and live loads are, likewise, relatively easy to calculate. Once these are determined, the specifier can select the type of pipe to use and know the safety margin.

### *Thermoplastic Sewer Pipe*

Thermoplastic sewer pipe depends on the installer to limit deflection by compacting the sidefill support. Earth loads and live loads are easily calculated using the minimum trench widths established in ASTM-D2321. The added stiffness from the sidefill plus the pipe stiffness combine to resist the earth and live loads while limiting the deflection.

Table 1 lists crush strengths of cast iron soil pipe and the minimum pipe stiffness and ring deformation allowed by various popular “thermoplastic sewer” pipes. The minimum stiffness and ring deformation values of the plastic materials stated in pounds per square inch and pounds per linear foot should be used in selection of the piping material. Thermoplastic pipe with a higher pipe stiffness and ring deformation value still requires sidefill support to limit deflection; one with a lower pipe stiffness requires still more. We also include a table with calculated earth loads and live loads for various sizes of pipe in three-foot to seven-foot depths. The trench widths are established by ASTM D2321 for the size of plastic pipe indicated.

Because cast iron soil pipe and plastic pipe are classified as rigid and flexible materials, respectively, the tests for measuring the performance of each material are different. In the case of cast iron soil pipe, minimum ring crush loads can be determined for the different classes of pipe. For plastic pipe, parallel plate loading tests are used to make a determination of the minimum allowable PSI necessary to deflect a pipe five percent. Cast iron is measured to destruction, whereas some thermoplastic piping is considered out of specification when more than five percent deflection occurs at a certain PSI or PLF.

An example of the differences in three materials in buried conditions can be seen in Table 1. ASTM 2665 requires that 10” Schedule 40 PVC pipe should not be deflected more than five percent at 503 lbs. per linear foot to be within specification. In the case of cast iron, the minimum ring crushing load on 10” pipe service is 4,342 pounds per linear foot. Cast iron is eight times stronger than its plastic counterpart without relying on any compacted backfill or sidefill support. In thermoplastic materials, with their lower stiffness values and ring deformation values, greater stiffness can only be obtained by adjusting trench width, backfill, sidefill, and compaction.

From an operating perspective, Table 2 illustrates actual earth and live loads subjected to thermoplastics buried at three feet. For example, on 6” pipe buried three feet, earth loads of 465 lbs. and live loads of 563 lbs. would be exerted. However, if you look at the pipe stiffness values and ring deformation values shown in the table, you will note that the plastic pipe is rated at 596 lbs. per linear foot of pressure at five percent deflection. Theoretically, a thermoplastic piping material could meet the requirements of the specification at 596 lbs. but might not meet the total load on the pipe of 1028 lbs. Again, adjustments to backfill and compaction are necessary for the thermoplastic pipe to carry the combined weight of earth load and live load. Cast iron requires no additional support.

**TABLE 1**  
***Crush Loads/Maximum Allowable Deflection for***  
***Sewer Pipes (Lbs. Per Linear Ft.)***

Crush Load			Maximum Allowable Deflection (5%)				
CI (No Hub)	CI (Service Wt.)		PVC SCH40 ASTM D2665 Solid Wall	PVC SCH40 ASTM F891 Cellular Core	PVC Sewer SDR 35 ASTM D3034	ABS SCH40 ASTM D2661 Solid Wall	ABS SCH40 ASTM F628 Cellular Core
4"	4877	4451	837	540	125	513	473
6"	3344	2997	596	477	183	378	298
8"	3674	3674	Not Mfg.	518	238	Not Mfg.	Not Mfg.
10"	4317	4342	503	387	297	Not Mfg.	Not Mfg.
12"	Not Mfg.	3632	482	383	352	Not Mfg.	Not Mfg.

**TABLE 2**  
***Anticipated Loads for Buried Pipe***

PIPE SIZE		4"	6"	8"	10"	12"
3.0'	EL	392	465	538	611	685
	<u>TL</u>	<u>282</u>	<u>563</u>	<u>774</u>	<u>986</u>	<u>1232</u>
	L	674	1028	1312	1597	1917
3.5'	EL	439	523	607	692	777
	<u>TL</u>	<u>192</u>	<u>384</u>	<u>576</u>	<u>736</u>	<u>896</u>
	L	631	907	1183	1428	1673
4.0'	EL	482	576	672	768	865
	<u>TL</u>	<u>144</u>	<u>320</u>	<u>480</u>	<u>624</u>	<u>752</u>
	L	626	896	1152	1392	1617
4.5'	EL	521	626	732	839	947
	<u>TL</u>	<u>120</u>	<u>272</u>	<u>417</u>	<u>536</u>	<u>648</u>
	L	641	898	1148	1375	1595
5.0'	EL	556	671	788	906	1025
	<u>TL</u>	<u>96</u>	<u>240</u>	<u>352</u>	<u>448</u>	<u>544</u>
	L	652	911	1140	1354	1569
5.5'	EL	589	713	840	969	1099
	<u>TL</u>	<u>88</u>	<u>192</u>	<u>312</u>	<u>392</u>	<u>488</u>
	L	677	905	1152	1361	1587
6.0'	EL	618	752	889	1028	1168
	<u>TL</u>	<u>80</u>	<u>160</u>	<u>272</u>	<u>336</u>	<u>432</u>
	L	698	912	1161	1364	1600
6.5'	EL	645	788	934	1083	1234
	<u>TL</u>	<u>76</u>	<u>148</u>	<u>248</u>	<u>308</u>	<u>396</u>
	L	721	936	1182	1391	1630
7.0'	EL	670	821	976	1135	1296
	<u>TL</u>	<u>72</u>	<u>136</u>	<u>224</u>	<u>280</u>	<u>360</u>
	L	742	957	1200	1415	1656

EL = Earth Load in Pounds; TL = Truck Load in Pounds; L = Total Load in Pounds.

As you can see, cast iron offers the greatest margin of safety for the owner, architect, engineer, and inspector. The installation requirements for backfill and support for cast iron are minimal when compared to those required for thermoplastics to perform reliably. Cast iron is often less expensive to purchase and properly install in both the short- and long term.

# **CHAPTER VII RECOMMENDATIONS FOR DEEP BURIAL OF CAST IRON SOIL PIPE**

This chapter presents the result of an extensive study on the maximum depth of burial of cast iron soil pipe when three types of bedding conditions are used. It was compiled and edited with the cooperation and direction of Utah State University Professor Emeritus of Civil Engineering, Dr. Reynold King Watkins, Ph.D.

Dr. Watkins is a registered professional engineer and engineers' consultant. He authored the textbook *Principles of Structural Performance of Buried Pipes* in 1977 (U.S.U. Printing Services), and has two other texts to his credit as well as more than thirty reports and articles.

An acknowledged expert on buried structures, Dr. Watkins has been an engineering educator since 1947 and holds membership in numerous professional and honorary societies.

## **SUMMARY AND CONCLUSIONS**

Within the parameters of established trench widths and installation conditions described in this report, cast iron soil pipe may be buried at depths of up to 1,000 feet, depending on class of pipe, diameter, and installation conditions. (See Table 1.)

Cast iron soil pipe has the properties desirable for deep burial: beam strength, pipe stiffness, and resistance to stress. By creating a compacted soil arch over the pipe packed in a compressible soil envelope, the allowable depth of burial can be doubled.

Design based on soil-load assumptions that give the worst stress is more practical than computerized analysis, which requires known soil properties and boundary conditions, none of which are readily available or controllable on most projects.

In using structural design information on underground cast iron soil pipe installations, it must be recognized that there are variations in soil characteristics and construction practices throughout the country. This data is presented here as a convenient reference. Effective design requires conformity with specific construction practices and recognition that the computations are based on design information regarding earth loads, truckloads, trench depths, and other factors.

## **STRUCTURAL DESIGN OF BURIED CAST IRON SOIL PIPE**

To design is to compare anticipated performance with desired performance within performance limits. For cast iron soil pipe, the structural performance limit is leakage. Excessive deformation causes breaks and leaks, but excessive deformation of cast iron soil pipe is directly related to stress, so stress determines basic structural performance. Anticipated (analyzed) stress must be within the stress limit, called strength. Because of interaction between the pipe and the soil in which it is buried, stress analysis is complicated.

Available now are computerized mathematical techniques of analysis, such as the finite-element method, but such techniques are generally better than the installations they are designed to model.

**TABLE 1**  
**Maximum Allowable Trench Depths (H) for Cast Iron Soil Pipe (In Ft.)**

No Hub Pipe Size	Condition 1		No Hub Pipe Size	Condition 2		No Hub Pipe Size	Condition 3	
	P (lbs./ft. <sup>2</sup> )	Trench Width		P (lbs./ft. <sup>2</sup> )	Trench Width		P (lbs./ft. <sup>2</sup> )	Trench Width
1½"	57434	299	1½"	95720	499	1½"	191400	1000
2"	36300	189	2"	60400	315	2"	120900	1000
3"	17100	89	3"	28500	148	3"	57000	475
4"	14000	73	4"	23300	121	4"	46600	388
5"	9400	49	5"	15700	81	5"	31300	261
6"	6600	42	6"	10900	70	6"	21900	182
8"	5400	45	8"	9000	75	8"	18000	150
10"	5000	42	10"	8200	68	10"	16800	140

Service Pipe Size	Condition 1		Service Pipe Size	Condition 2		Service Pipe Size	Condition 3	
	P (lbs./ft. <sup>2</sup> )	Trench Width		P (lbs./ft. <sup>2</sup> )	Trench Width		P (lbs./ft. <sup>2</sup> )	Trench Width
2"	43300	225	2"	72100	376	2"	144200	1200
3"	20000	104	3"	33400	174	3"	66800	557
4"	13000	68	4"	21600	112	4"	43200	360
5"	8400	44	5"	14000	73	5"	28000	233
6"	5900	38	6"	9800	63	6"	19600	163
8"	5400	45	8"	9000	75	8"	18000	150
10"	5100	43	10"	8500	71	10"	17000	142
12"	3600	30	12"	5900	49	12"	11900	99
15"	3700	31	15"	6100	51	15"	12200	102

**TABLE 1**  
**Maximum Allowable Trench Depths (H) for Cast Iron Soil Pipe (In Ft., continued)**

Extra Heavy Pipe Size	Condition 1		Extra Heavy Pipe		P (lbs./ft. <sup>2</sup> )	Condition 2		Extra Heavy Pipe		P (lbs./ft. <sup>2</sup> )	Condition 3 Trench Width 18" or Greater					
	18"	24"	24"	36"		18"	24"	24"	36"			2"	3"	4"	5"	6"
2"	266	266	266	266	85200	444	444	444	444	170400	1420					
3"	209	209	209	209	67000	349	349	349	349	134000	1116					
4"	122	122	122	122	39200	204	204	204	204	78300	653					
5"	99	80	80	80	25700	165	134	134	134	51300	428					
6"	70	57	57	57	18100	116	94	94	94	36200	302					
8"	79	61	49	49	15800	131	101	82	82	31500	263					
10"	72	72	55	55	14400	120	120	92	92	28800	240					
12"	51	51	39	39	10100	84	84	65	65	20200	169					
15"	50	50	50	50	9200	77	77	77	77	18400	153					

P = Design Soil Pressure; The sum of the dead load and live load pressures at the level of the top of the pipe (maximum allowable vertical soil pressure).

H = Maximum Trench Depth; the maximum height of soil cover over the top of the pipe.

Condition 1 = No pipe bedding; hard trench bottom; continuous line support. (See Figure 1 and Appendix B.)

Condition 2 = Bedding placed for uniform support; soil under haunches of pipe should be compacted. (See Figure 2 and Appendix B.)

Condition 3=Select, loose soil envelope placed about the pipe as packing, with a dense soil arch compacted up over the envelope. (See Figure 3 and Appendix B.)



It is not yet practical to bury a soil pipe in soil that has properties and boundary conditions as precisely known and as precisely controlled as assumed by the analysis.

Consequently, practical design is based on simplifying assumptions of soil loads which, when analyzed, yield the worst stresses. These stresses are compared to strengths that have been reduced by a reasonable safety factor.

Because strength is the maximum stress caused by a test load on the pipe at failure, why not equate the worst stress to the test strength in order to provide a design equation that relates anticipated soil pressure to test load? Design then becomes a process simply of comparing the anticipated soil pressure to an equivalent pipe test load that has been reduced by a safety factor.

The soil pressure is the vertical soil pressure  $P$  acting down on the pipe. The test load (strength) is a laboratory test to failure of the pipe.

For cast iron soil pipe, basic design includes: ring design, and longitudinal beam design. It is sufficient to analyze each separately.

## RING DESIGN

For ring design, the external vertical soil pressure  $P$  on the ring, is compared to the strength  $W$  of the ring. Strength is defined as the vertical line load per unit length of the pipe barrel at which the pipe cracks (failure; see Figure 1). To determine the ring crushing load for a given size of pipe, recall that the three-edge ring bearing formula is used:

$$W = \frac{t^2 R}{.0795 (D_m)}$$

$W$  = three-edge bearing ring test crushing load (lbs./lin. ft.)

$t$  = thickness of pipe (in.)

$D_m$  = mean diameter (in.) (O.D.=thickness)

$R$  = modulus of rupture (45,000 psi for cast iron soil pipe)

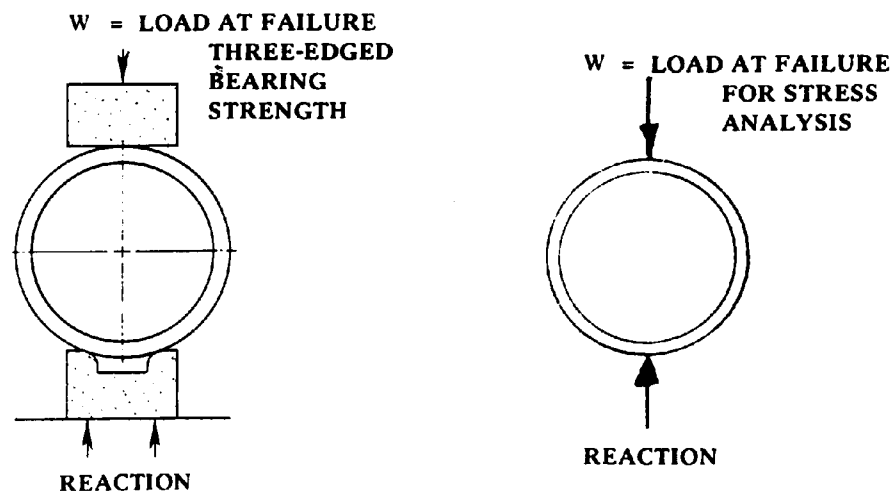

Figure 1—Ring Test Crushing Loads on Cast Iron Soil Pipe: Three-Edged Bearing Strength  $W$  Is Found by Laboratory Test On Samples of Pipe Barrel as Shown on the Left and Is Analyzed as a Concentrated Line Load and Concentrated Line Reaction as Shown on the Free-Body Diagram on the Right.

The strength so determined is called the three-edge bearing strength  $W$ . (See Appendix A for a complete description.) Values for  $W$  are listed in Table 2.

The soil pressure on the pipe must be related to  $W$ . (See Figure 1.) The typical worst cases of soil pressure and reaction are shown in Table 2. The pressures and reactions on the ring depend on installation conditions. Three basic installation conditions account for almost all typical ring loading. In every case the soil pressure is assumed to be uniformly distributed and vertically down on top of the pipe. Horizontal soil support is ignored.

This is a justifiable simplification that results in the worst stress condition in the ring. Horizontal soil pressures help to support the ring and so increase the safety factor against failure. However, the effectiveness of horizontal soil support depends either on excellent compaction of the soil envelope at the sides or on enough horizontal expansion of the ring to develop horizontal soil support. Neither case can be completely assured in typical soil pipe installations. (See Appendix A for further discussion.)

Installation Condition 1 (Figure 2) shows a concentrated vertical reaction on the bottom. This occurs if the pipe is supported throughout its length (except for bell holes) by a hard, flat surface. Even though loose soil might fall into its angle of repose under the haunches, loose soil would not change the basic concentrated reaction. For a vertical soil pressure of  $P$  on top, the reaction on the bottom is  $PD_m$ . From stress analysis and with a safety factor as discussed in Appendix A, the allowable vertical soil pressure for Installation Condition 1 is:

$$P = \frac{12W}{D_m} \quad (1)$$

$P$  = maximum allowable vertical soil pressure (lb./ft.<sup>2</sup>)

$D_m$  = mean diameter of pipe ( $D_o - t$ ) (in.)

$D_o$  = outside diameter (in.)

$t$  = thickness of barrel (in.)

$W$  = three-edge bearing load at failure (strength per foot of length of pipe) (lb./ft.)

For design, the above equation can be solved or the solutions can be found in Table 1.

Installation Condition 2 (Figure 2) shows a uniformly distributed vertical soil reaction on the bottom. This occurs if the pipe is supported throughout its length by a carefully placed soil bedding under the haunches such that the bedding cradles the ring with a uniform vertical pressure. Methods of achieving such a bedding are discussed in Appendix B. From stress analysis and with a safety factor as discussed in Appendix A, the allowable vertical soil pressure for Installation Condition 2 is:

$$P = \frac{20W}{D_m} \quad (2)$$

where units are the same as for Installation Condition 1. For design, the above equation can be solved or the solutions can be found in Table 2.

Installation Condition 3 (Figure 2) shows a uniformly distributed reaction as in Installation Condition 2 except that pressure on the ring is reduced to less than one-half by packing the pipe in a select loose soil envelope of twice the pipe diameter or more in height, as shown in Figure 3. To achieve permanent soil arching, the backfilling must be a conscious effort to compact a dense soil arch up and over the pipe springing from good abutments without loading the pipe and without compacting the select soil envelope. In a wide trench or in an embankment the sidefill must be carefully compacted in

**TABLE 2**  
**Ring Test Crushing Loads on Cast Iron Soil Pipe**

Pipe Size In.	No Hub			Service Weight			Extra Heavy				
	Nominal O.D. (D <sub>0</sub> )	Nominal Thickness (1)	Ring Crushing Load* (w)	Pipe Size In.	Nominal O.D. (D <sub>0</sub> )	Nominal Thickness (1)	Ring Crushing Load* (w)	Pipe Size In.	Nominal O.D. (D <sub>0</sub> )	Nominal Thickness (1)	Ring Crushing Load* (w)
1½	1.90	.16	8328	—	—	—	—	—	—	—	—
2	2.35	.16	6617	2	2.30	.17	7680	2	2.38	.19	9331
3	3.35	.16	4542	3	3.30	.17	5226	3	3.50	.25	10885
4	4.38	.19	4877	4	4.30	.18	4451	4	4.50	.25	8324
5	5.30	.19	3999	5	5.30	.18	3582	5	5.50	.25	6739
6	6.30	.19	3344	6	6.30	.18	2997	6	6.50	.25	5660
8	8.38	.23	3674	8	8.38	.23	3674	8	8.62	.31	6546
10	10.56	.28	4317	10	10.50	.28	4342	10	10.75	.37	7465
				12	12.50	.28	3632	12	12.75	.37	6259
				15	15.88	.36	4727	15	15.88	.44	7097

\*Pounds per linear foot

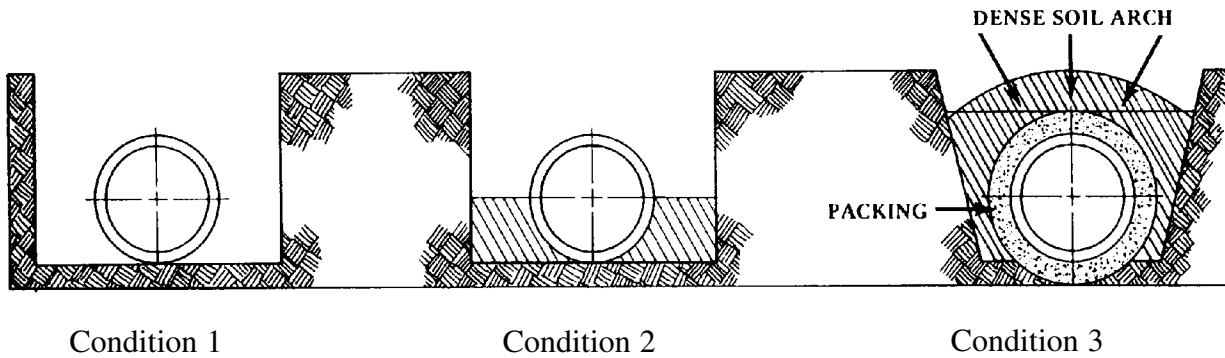

Figure 2—Structural Design of Cast Iron Soil Pipe. Condition 1: No Pipe Bedding, Hard Trench Bottom, Continuous Line Support; Condition 2: Bedding Placed for Uniform Support, Soil Under Haunches of Pipe Should be Compacted; Condition 3: Select Loose Soil Envelope Placed Around the Pipe as Packing With a Dense Soil Arch Compacted Up and Over the Envelope.

one layer below the pipe spring line and one or more layers above the pipe spring line, and on up to the top of the soil envelope without compacting the envelope. The soil should be placed on both sides before compacting in order to reduce sideshift. Of course the compacted sidefill part of the arch could be the same select soil used for the envelope, provided that a loose soil blanket is left in contact with the pipe. If the trench is less than about two pipe diameters in width, good, rigid trench sidewalls may serve as the sidefill part of the arch. In either trench condition or embankment condition, the soil arch is completed over the top by placing a lift of about one foot of soil above the envelope. This lift is then compacted from the outside of the embankment or trench in toward the center line of the pipe such that a soil keystone in the middle of the arch is compacted last. If the soil arch is compacted to 90 percent AASHTO-T99,<sup>1</sup> and if the selected soil envelope is uncompacted fine aggregate for concrete, or its equivalent, the compressibility

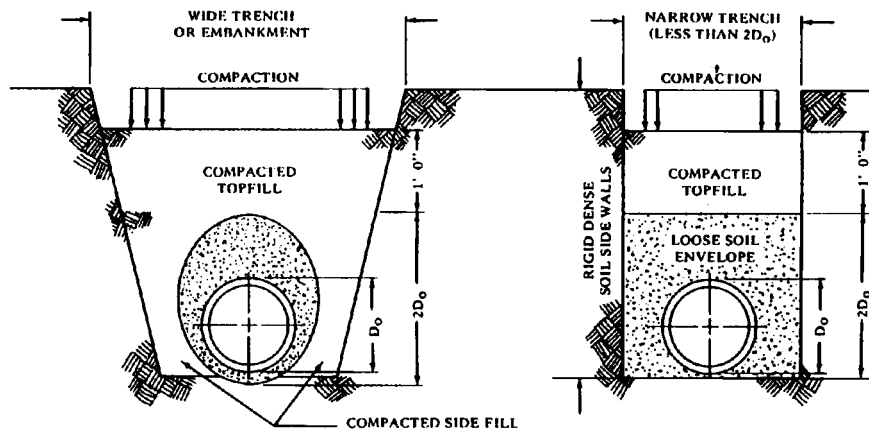

Figure 3—Conditions for Developing Arching Action of Soil Over the Pipe To Reduce the Vertical Soil Pressure Acting on the Top of the Pipe Ring.

<sup>1</sup> American Association of State Highway and Transportation Officials Pamphlet T-99, 1981 Edition.

ratio is 1:4 and the vertical soil pressure felt by the pipe is about half of the average soil pressure at that depth. Consequently the allowable vertical soil pressure for Installation Condition III is:

$$P = \frac{40W}{D_m} \quad (3)$$

where units are the same as for Installation Condition 1. For design, the above equation can be solved or the solutions found in Table 2.

## DESIGN SUMMARY

In summary, for design, the vertical allowable soil pressure  $P$  on cast iron soil pipe must be less than the following values, depending on  $W$  and  $D$ , on the conditions of installation:

Installation Condition (bedding)	Design Soil Pressure $P$ (lb./ft. <sup>2</sup> )	
1	$P = \frac{12W}{D_m}$	(4)

2	$P = \frac{20W}{D_m}$	(5)
---	-----------------------	-----

3	$P = \frac{40W}{D_m}$	(6)
---	-----------------------	-----

$P$  = maximum allowable vertical soil pressure at the level of the top of the pipe (lb./ft.<sup>2</sup>)

$W$  = three-edge bearing load per unit length of pipe at failure (lb./ft.) (cracking of a pipe barrel section in a laboratory test)

$D_m$  = mean diameter ( $D_o - t$ ) (in.)

$D_o$  = outside diameter (nominal) (in.)

$t$  = wall thickness of barrel (in.)

For a given pipe the allowable vertical soil pressure  $P$  can be found from these equations or from the solutions in Table 2 of typical cast iron soil pipe now on the market.

Installation Condition 1 applies if no attempt is made to place a bedding for the pipe beyond a hard surface that is flat enough to provide continuous line support. If the line support is not continuous, the pipe must be designed as a longitudinal beam.

Installation Condition 2 applies if a bedding is carefully placed under the haunches in order to develop essentially in-form pressure support. Soil under the haunches should be compacted. (See Appendix B.)

Installation Condition 3 applies only if a select loose soil envelope is placed around the pipe as a packing and if a dense soil arch is compacted up and over the pipe and packing. A good, dense trench sidewall can serve as sidefill springing from a good abutment. The sidefills or trench sidewalls must be dense enough that the compressibility is less than one-fourth the compressibility of the loose soil envelope. If the sidewalls are not solid, there must be enough clearance for heavy compaction of the sidefill to 90 percent AASHTO-T99 density. (See Appendix B.)

## PRESSURE CONCENTRATION FACTOR

The vertical soil pressure  $P$  transferred to the top of the pipe is affected by many variables including the installation condition used, the width of the trench, and various shearing stresses that may be caused by tremors, thermal variations, moisture variations, and any other stresses that can cause soil movement. In order to compensate for these variables, a pressure concentration factor  $K$  was derived experimentally at Utah State University, and conservative values based on the ratio of trench widths to pipe outside diameters are as follows:

<u>K</u>	<u>Ratio of Trench Width to Pipe Diameter</u>	<u>Backfill Classification</u>
1	2 or less	Trench backfill
1.3	3	Transition backfill
1.6	4 or more	Embankment backfill

The value  $K$  is used to calculate the maximum trench depths  $H$  (or maximum depths of burial) in Table 2 by the following formula:

$$H = \frac{P}{120K} \quad (7)$$

When:

$H$  = maximum trench depth

$P$  = total vertical soil pressure

$K$  = pressure concentration factor

120 = soil weight (lb./ft.<sup>3</sup>)

## VERTICAL SOIL PRESSURE

The vertical soil pressure  $P$  is the sum of dead load and live load pressures at the level of the top of the pipe:

$$P = P_1 + P_d \quad (8)$$

$P_1$  = vertical soil pressure at the level of the top of the pipe due to the effect of live loads on the surface (lb./ft.<sup>2</sup>).

$P_d$  = dead weight soil pressure at the level of the top of the pipe (lb./ft.<sup>2</sup>).

For most installations, both the live load pressure  $P_1$  and the dead load pressure  $P_d$  as well as the combined pressure  $P$  can be read on the graph in Figure 4. In this graph the unit weight of soil is assumed to be 120 pounds per cubic ft. This is generally conservative considering the arching action of the soil over the pipe. However, if unit weight is significantly different, then a correction can be made for the deadweight.

Table 3 lists the maximum live truck super-loads on cast iron soil pipe resulting from two passing H20 or HS20 trucks on an unpaved surface or flexible pavement.

## INSTALLATION EXAMPLE

Suppose that you want to install a 10" No Hub pipe system under five feet of earth cover, in a 36" wide ditch using Installation Condition 2.

1. See Table 3 or Figure 4 for load determinations:

- Truck load =  $P_1$   
 $P_1$  at a depth of 5 feet = 544 lb./sq. ft.
- Earth load =  $P_d$   
 $P_d$  at a depth of 5' = 600 lb./sq. ft.  
 ( $P_d$  also equals 120 lb/cu. ft. x 5 ft. deep = 600 sq. ft.)
- Total load at top of pipe =  $P = P_1 + P_d$   
 $P = 544 \text{ lb./sq. ft.} + 600 \text{ lb./sq. ft.} = 1144 \text{ lb./sq. ft.}$
- From Table 1 it can be seen that a 10" No Hub pipe installed in accordance with the above conditions can be placed at a maximum depth of 43 feet. This is the equivalent to 8200 lb./ft.<sup>2</sup> of dead load.

**TABLE 3**  
*Truckloads*

Trench Depth H in ft.	Load lbs./sq. ft.	Trench Depth H in ft.	Load lbs./sq. ft.
2	2074	6	432
2½	1514	8	288
3	1120	10	192
3½	896	12	144
4	752	16	96
5	544		

The above loads were calculated by methods found in American National Standards Institute Specification A21.1.

Neglect the live load (truck load) when it is less than 100 lbs./sq. ft.

Earth load is based upon a soil weight of 120 lbs./sq. ft.<sup>3</sup>

## BEAM STRESSES

Cast iron soil pipe should not be installed by a method that will allow it to be subjected to excessive beam stresses. All cast iron soil pipe should be installed with a continuous bedding support which is at least equal to that of Installation Condition 1 shown in Figure 2. When a piping system is properly installed, beam stresses are negligible. If, however, proper bedding is not assured, longitudinal beam action should be evaluated.

Figure 5 depicts a simply supported pipe with the vertical soil pressure loading it uniformly along the barrel and bending it as a beam. The load at which beam failure will occur can be calculated as follows:

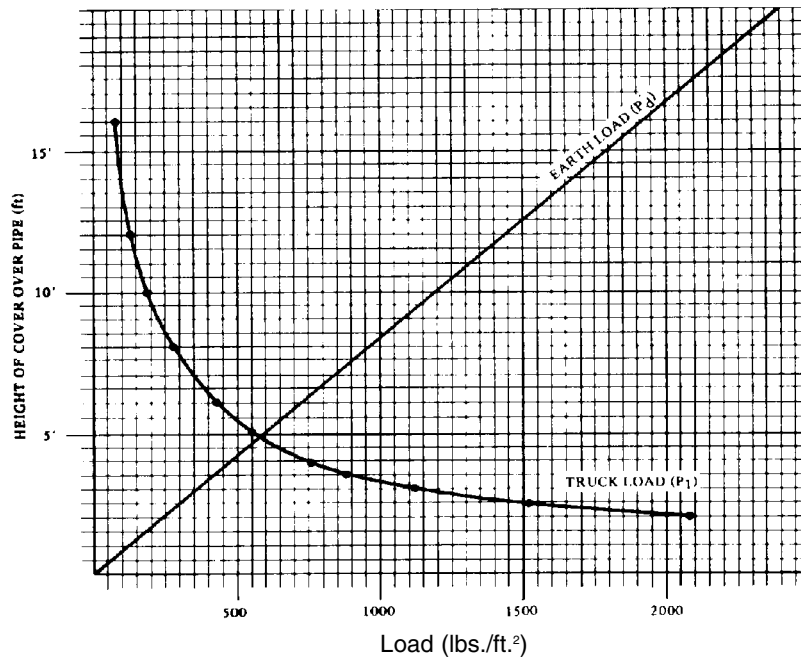

Figure 4—Vertical Loads for Cast Iron Soil Pipe.

$$P = \frac{\pi}{4} \left( \frac{D_o^4 - D_i^4}{D_o^2 \cdot L^2} \right) S \quad (9)$$

$P$  = Vertical Soil Pressure at top of pipe (lb./ft.<sup>2</sup>)

$D_o$  = Outside Diameter of pipe (in.)

$D_i$  = Inside Diameter of pipe (in.)

$t$  = Wall Thickness of pipe barrel (in.)

$S$  = Longitudinal Tensile Strength of pipe (25,000 lbs./in.<sup>2</sup>)

$L$  = Length of Supported Span (ft.)

In Table 4 the maximum trench depths  $H$  are tabulated for pipe sections loaded as beams. They were calculated using the following parameters:

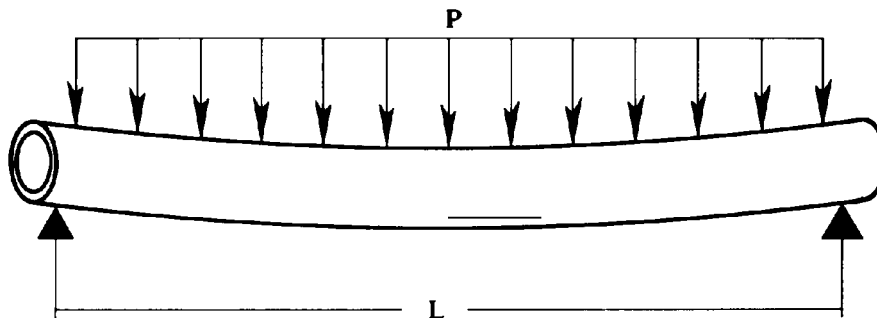

Figure 5—Simply Supported Pipe.



- The vertical soil pressure P was calculated using Equation 9.
- An additional safety factor of 1.5 is allowed for design purposes, and the soil weight is calculated at 120 lab./ft<sup>3</sup>.
- The cast iron service soil pipe is installed according to Installation Condition 1 and in a 36" wide ditch, except for the distance of the span between supports.
- Each bearing supporting the pipe contacts the pipe barrel for a minimum of 12" along the length of the pipe on both sides of the span.
- The maximum trench depth, H (in feet), at the top of the pipe is calculated as follows:

$$H = \frac{P}{120KS_f} \quad (10)$$

Where:

P = vertical soil pressure at top of pipe in pounds per square foot.

K = pressure concentration factor = 1.6 for embankment backfill.

S<sub>f</sub> = safety factor = 1.5

**TABLE 4**  
***Maximum Trench Depths H for Service Pipe Loaded as a Beam***

Size	2 Ft. Span		2.5 Ft. Span		5 Ft. Span	
	P	H	P	H	P	H
2" SV**	12250	43	7840	27	1960	7
3" SV	18850	65	12064	42	3016	11
4" SV	26875	93	17200	60	4300	15
5" SV	33900	118	21696	75	5424	19
6" SV	40800	141	36112	91	6528	23
8" SV	69700	242	44608	155	11152	39
10" SV	106550	370	68192	237	17048	59
12" SV	128500	446	82240	285	20560	71
15" SV	209625	728	134160	486	33540	117

\*External truck loads would be likely to cause failure of this pipe.

\*\*SV=Service Cast iron Pipe.

Pipe with H values in the area below the heavy line do not require evaluation of beam stresses. They would tend to fail by ring crushing before the maximum beam load is attained. Therefore, the values in Table 1 would determine the maximum trench depths.

H values or maximum depths of burial for No-Hub pipe would be similar to those for service pipe, whereas those for extra heavy pipe would be greater.

As the span between supports gets greater, the resistance to beam load decreases and the maximum depth of burial decreases.

As the pipe increases, the resistance to beam load increases and the maximum depth of burial increases. (It should be noted that the exact reverse is true for pipe subjected to ring crushing forces, i.e., as the pipe size increases, the resistance to ring crushing load decreases and the maximum depth of burial decreases.)

# CHAPTER VIII

## FLOW THEORY AND CAPACITY

Just as structural analysis is used to predetermine the structural stability of buried cast iron soil pipe, hydraulic analysis is used to provide an adequate flow capacity for the sewage or drainage system in which the pipe is installed. Hydraulic analysis considers the variables that govern flow capacity, including the pipe diameter, the length of the sewer or drain line, the slope of the pipe, and the roughness or smoothness of the pipe's internal surface. All of these variables affecting flow in a particular system must be analyzed so that the pipe is sized and installed to efficiently carry the maximum volume of water expected to flow through the system under peak operating conditions.

The question, "How much water will flow through a certain size?" is frequently asked regarding flow capacity. Unfortunately, the inquiry mentions only one of the variables that can materially alter the flow, and more complete information on the particular installation must be obtained before an accurate and useful response can be made. It is the purpose of this chapter to review flow theory and the determination of flow capacity, and thereby present practical information relating to proper hydraulic design for cast iron soil pipe wastewater systems.

### FLOW IN SEWERS AND DRAINS

Most cast iron soil pipe in sewage and drainage systems flow only partially full (i.e., free surface flow or gravity flow), and would properly be termed "open channel." Because frictional losses are generally independent of pressure, the flow of water in both full pipes and open channels is governed by the same basic laws and expressed in formulas of the same general form.<sup>1</sup>

The laws applying to conduit flow usually assume steady, uniform conditions, or an even distribution of liquid throughout the system. This continuity of flow, although generally not maintained over an extended period of time, is closer to the conditions likely to exist in cast iron soil pipe sewers—as opposed to those in drains, in which surge flow frequently occurs. It is customary, however, to utilize the same hydraulic principles to determine the flow in sewers and to estimate the capacities of sloping drains in and adjacent to buildings.<sup>2</sup>

Because the amount of suspended solids in sewage is usually too small to have more than a negligible effect on the flow pattern, the flow of sewage in a clean conduit behaves in the same manner as the flow of water, with one possible exception: namely, that sewage could conceivably cause a change in surface condition or an accumulation of slime on the inner walls of the conduit over a period of years. This would have a long-term influence on the conduit's flow, altering its pattern from that found in a comparable conduit used to carry water.<sup>3</sup> However, the many detergents commonly introduced into sewers tend to maintain their cleanliness, thus making water-flow measurements still applicable, even over the long term, to sewage-flow measurements in the same conduits.

<sup>1</sup> Ernest W. Schoder and Francis M. Dawson, *Hydraulics*, 2nd edition, New York: McGraw-Hill Book Company, Inc., 1934, p. 237; Horace W. King, Chest O. Wisler and James G. Woodburn, *Hydraulics*, 5th edition, New York: John Wiley and Sons, Inc., 1948, p. 175; Horace W. King and Ernest F. Brater, *Handbook of Hydraulics for the Solution of Hydrostatic and Fluid-Flow Problems*, 5th edition, New York: McGraw-Hill Book Company, Inc., 1963, p. 6-1.

<sup>2</sup> Robert S. Wyly, *A Review of the Hydraulics of Circular Sewers in Accordance with the Manning Formula*, Paper presented at 54th Annual Meeting of the American Society of Sanitary Engineering, October 9–14, 1960, Washington, D.C.: U.S. Department of Commerce, National Bureau of Standards, 1960, p.1.

<sup>3</sup> Wyly, *op cit.*, p. 4.

## LAMINAR FLOW AND TURBULENT FLOW

Two basic types of flow can occur in conduits used to transport fluids. The flow is termed *laminar* when the fluid moves, without eddies or cross currents, in straight lines parallel to the walls of the conduit. Once the flow velocity reaches a “critical” rate, cross currents set in causing the fluid to move through the conduit in an irregular manner, in which case the flow is said to be *turbulent*.

The best criterion for determining the type of flow that prevails in a particular conduit under specified conditions is the *Reynolds number*, conceived by Professor Osborne Reynolds of Owens College, Manchester, England, and first used in 1883 to explain the flow of water in pipes.<sup>4</sup> Reynolds determined that that a general increase in the rate or velocity of flow eventually transforms it from laminar to turbulent and that the flow reverts back to laminar as its velocity diminishes. By means of experiments using water at different temperatures, this phenomenon was found to depend not only on the velocity of flow, but also on the viscosity and density of the fluid and the diameter of the pipe. Reynolds expressed it numerically as:

$$\frac{\text{diameter of the pipe} \times \text{velocity} \times \text{density of fluid}}{\text{viscosity of fluid}}$$

This expression, which can be written as  $DVp/u$ , is known as the *Reynolds Number*. It has no physical dimensions: It is a mere number, its value independent of the system of units (e.g., foot, second, or pound) used to express its components. At low Reynolds numbers, when viscous forces are predominant, laminar flow occurs. Assuming the flow velocity is less than critical, the tendency of the fluid to wet and adhere to the pipe walls and the viscosity of its adjacent layers contributes to streamlining the flow. However, once a certain value of the Reynolds number is reached, the flow turns unstable and following a brief transition period becomes clearly turbulent. Extensive testing of circular cross sections of commercial pipe samples has established that for Reynolds numbers below a value of about 2,000, laminar flow can be expected, whereas turbulent flow occurs at values above 3,000. The range between these critical numbers is referred to as the *transition zone*.<sup>5</sup>

As a general rule, turbulent flow is considered to be characteristic of all but an extremely limited number of cast iron soil pipe sewage and drainage systems, because the velocity of the flow of water in almost all installations results in Reynolds numbers above 10,000. Laminar flow, which is more akin to the flow of water in very small tubes and to the flow of oil and other viscous liquids in commercial pipe, occurs in sewers and drains only at unusually low discharge rates and slopes.<sup>6</sup> The predominance of turbulent flow has been established in extensive studies made by the National Bureau of Standards showing that turbulent flow occurs in three- and four-inch gravity drains at a slope of  $\frac{1}{4}$  inch per foot for half-full or full conduit flow.

## PREMISES GOVERNING FLOW DETERMINATION

Determination of the flow in cast iron soil pipe sewers and drains is based on the hydraulic premises discussed above, which can be restated as follows:

<sup>4</sup> Osborne Reynolds, “An Experimental Investigation of the Circumstances which Determine Whether the Motion of Water Will Be Direct or Sinuous and the Laws of Resistance in Parallel Channels,” *Phil Trans Roy. Soc.*, London, 1893, or *Sci. Papers*, Vol. 2, p. 51.

<sup>5</sup> Schoder and Dawson, *op. cit.*, pp. 230–2, 248–9; King, Wisler and Woodburn, *op. cit.*, pp. 175–9; J. Jennings, *The Reynolds Number*, Manchester: Emmott and Company, Ltd., 1946. pp. 5–16

<sup>6</sup> King, Wisler and Woodburn, *op. cit.*, p. 178; Schoder and Dawson, *op. cit.*, p. 231; Wyly, *op. cit.*, p. 2.

- The flow is of the open-channel type with the conduit partially full and the top surface of the wastewater exposed to the atmosphere.
- The flow is uniform with the mean velocity and depth of the wastewater constant throughout the entire length of the conduit.
- The flow of sewage behaves in the same manner as the flow of drainage water.
- The flow is fully turbulent with the wastewater moving through the conduit as a turbulent mass.

Figure 1 depicts a cross-section of a cast iron soil pipe open channel. It will be noted that the conduit is flowing only partially full, with the top surface of the wastewater exposed to normal atmospheric pressure. With  $D_s$  indicating the maximum depth of water in the cross section, the wetted perimeter  $P$  of the sewer or drain is represented by XYZ, the length of the line of contact between the wetted cross section and the surface of the channel. The hydraulic radius  $r$  of the sewer or drain is equal to  $a/P$ , the cross-sectional area of the stream divided by the wetted perimeter.

Figure 2 provides a representation of uniform flow in an open channel, showing the slopes of the hydraulic gradient, the energy gradient, and the invert. The *hydraulic gradient* represents the slope of the surface of the sewage or drainage water and depends on velocity head. The *energy gradient* is a graphic representation of total energy or total head, with the drop in the gradient  $H_f$  providing a measure of lost head due to friction. The distance between the energy gradient and the hydraulic gradient indicates the total energy or velocity head  $V^2/2g$  remaining at any point along the sewer or drain line. The *invert* is a line that runs lengthwise along the base of the channel at the lowest point on its wetted perimeter, its slope established when the sewer or drain is installed.

When the flow between points 1 and 2 (in Figure 2) is uniform, then the depth  $D_s$  of the sewage or drainage water, the mean velocity  $V$  and the velocity head  $V^2/2g$  are constant throughout the entire length  $L$ , and the slopes of the hydraulic gradient, the energy gradient, and the invert are parallel.

## FORMULAS FOR FLOW DETERMINATION

The determination of flow in a wastewater system centers around the relationship between the velocity of flow and the head or energy loss that results from friction. As the flow moves through the hydraulic system, it is retarded by friction and the loss of energy (i.e., the amount of energy that must be expended to overcome frictional resistance and maintain the flow). It should be noted that the smooth inner surface of cast iron soil pipe permits an efficient use of available energy, an important factor to consider in constructing a hydraulic system.

A number of formulas have been developed relating the velocity of flow and the loss of energy due to friction. The most prominent of these with application to open channel hydraulics was introduced by Manning (1890). Robert Manning, an Irish engineer, in 1890 proposed the following equation for friction-controlled flow:<sup>7</sup>

$$V = \frac{1.486}{n} r^{2/3} s^{1/2} \quad (1)$$

Over the years, the Manning formula has become widely recognized. It is the only empirical energy-loss formula that is extensively used to determine fully-turbulent, open channel flow. Among its advantages are the availability of numerous test results for establishing values of  $n$  and its inclusion of the hydraulic radius, which makes it adaptable to flow determination in conduits of

<sup>7</sup> Robert Manning, "Flow of Water in Open Channels and Pipes," *Trans. Inst. Civil Engrs.*, Vol. 20, Ireland, 1890.

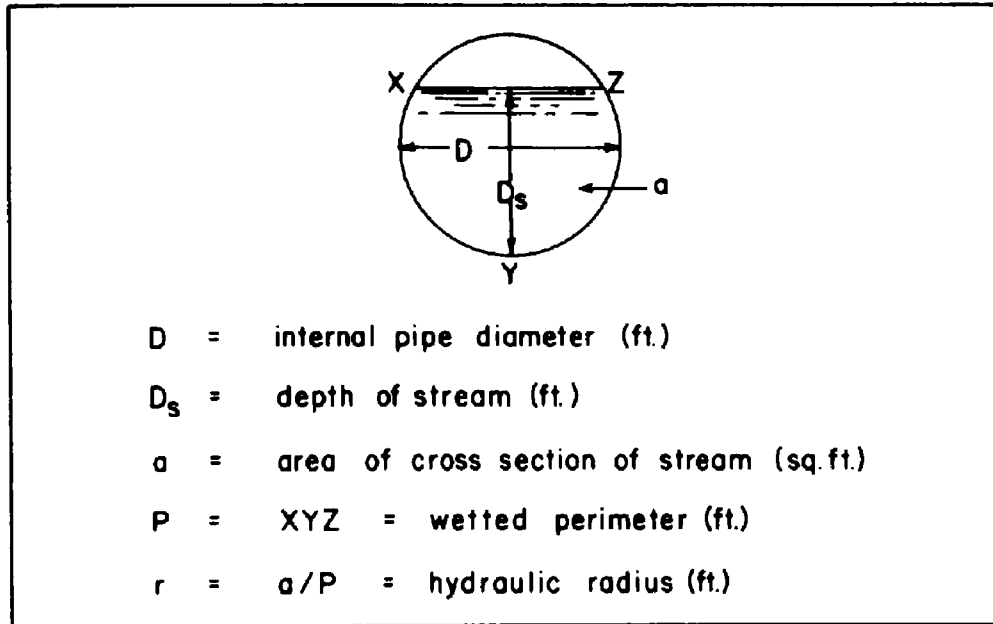

Figure 1—Cross Section of Cast Iron Soil Pipe Open Channel Sewer or Drain.

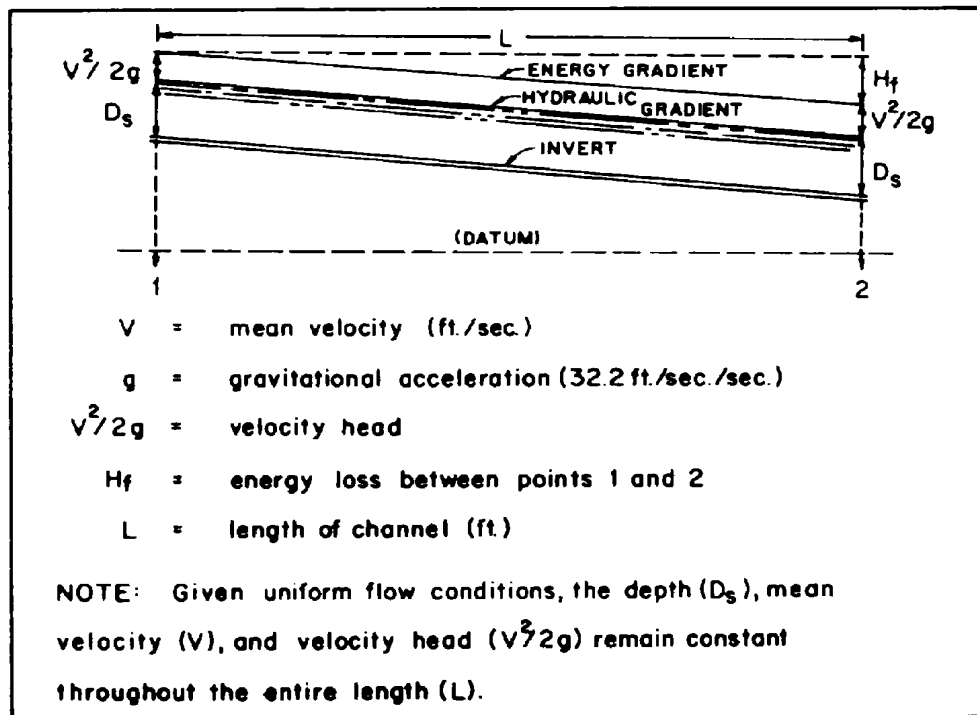

Figure 2—Uniform Flow of Open Channel Sewer or Drain.

various shapes.<sup>8</sup> The Manning formula, written in terms of discharge rate (Equation 2), is employed in the remainder of this chapter to determine the flow capacity of cast iron soil pipe. Its derivation requires that both sides of Formula 1 be multiplied by the area of the cross section of the stream.

$$Q = \frac{1.486}{n} ar^{2/3} s^{1/2} \quad (2)$$

Where:

Q = aV = discharge rate (cu. ft./sec.)

a = area of cross section of stream (sq. ft.)

r = roughness coefficient

Values of the *roughness coefficient* n in the Manning formula have been determined experimentally for various conduit materials, and a value of n = 0.012 is recommended for use in designing cast iron soil pipe hydraulic systems. Although lower, more favorable values of the coefficient are commonly obtained in controlled tests, particularly when coated pipe is used, the recommended value considers the possibility that bends and branch connections in an actual system may retard the flow.

Table 1 is provided to assist in the design of cast iron soil pipe sanitary systems. It indicates the slopes required to obtain self-cleansing or scouring velocities at various rates of discharge. A *self-cleansing velocity*, or a velocity sufficient to carry sewage solids along the conduit, permits the system to operate efficiently and reduces the likelihood of stoppages. A minimum velocity of two feet per second is the generally prescribed norm consistent with the removal of sewage solids, but a velocity of 2.5 feet per second can be used in cases where an additional degree of safety is desired.

In addition to designing self-cleaning velocities into sanitary sewers, it is considered good practice to impose an upper velocity limit of 10 feet per second in both sewers and drains. This restricts the abrasive action of sand and grit that may be carried through the system. However, because cast iron soil pipe is highly resistant to abrasion, it is most suitable for use where high velocity operation cannot be avoided.

## FLOW CAPACITY OF CAST IRON SOIL PIPE SEWERS AND DRAINS

The velocity and flow in cast iron soil pipe sewers and drains, computed by means of the Manning formula (Equation 2), are indicated in Table 2 and in Figures 3 through 6. Flow capacities are provided for systems using pipe sizes 2 through 15 inches, installed at a full range of slopes from 0.0010 to 0.10 ft./ft. and pipe fullness of one-quarter, one-half, three-quarters, and full. Both Table 2 and Figures 3 through 6 are based on the value 0.012 for n, the roughness coefficient, and on the internal pipe diameters specified by ASTM A74.

Although Equation 2 expresses the flow or discharge in cubic feet per second, flow in cast iron soil pipe is commonly measured in gallons per minute, and consequently the formula results have been multiplied by the conversion factor 448.86 (60 sec./min. x 7.481 gal./cu./ft.) to obtain the capacities indicated.

<sup>8</sup> King and Grater, *op. cit.*, pp. 6-16, 7-10 and 7-13.

**TABLE 1**  
***Slopes of Cast Iron Soil Pipe Sanitary Sewers***  
***Required to Obtain Self-Cleaning Velocities of 2.0 and 2.5 Ft./Sec.***  
***(Based on Mannings Formula with  $N = .012$ )***

Pipe Size (In.)	Velocity (Ft./Sec.)	$\frac{1}{4}$ Full		$\frac{1}{2}$ Full		$\frac{3}{4}$ Full		Full	
		Slope (Ft./Ft.)	Flow (Gal./Min.)	Slope (Ft./Ft.)	Flow (Gal./Min.)	Slope (Ft./Ft.)	Flow (Gal./Min.)	Slope (Ft./Ft.)	Flow (Gal./Min.)
2.0	2.0	0.0313	4.67	0.0186	9.34	0.0148	14.09	0.0186	18.76
	2.5	0.0489	5.84	0.0291	11.67	0.0231	17.62	0.0291	23.45
3.0	2.0	0.0178	10.77	0.0107	21.46	0.0085	32.23	0.0107	42.91
	2.5	0.0278	13.47	0.0167	26.82	0.0133	40.29	0.0167	53.64
4.0	2.0	0.0122	19.03	0.0073	38.06	0.0058	57.01	0.0073	76.04
	2.5	0.0191	23.79	0.0114	47.58	0.0091	71.26	0.0114	95.05
5.0	2.0	0.0090	29.89	0.0054	59.79	0.0043	89.59	0.0054	119.49
	2.5	0.0141	37.37	0.0085	74.74	0.0067	111.99	0.0085	149.36
6.0	2.0	0.0071	43.18	0.0042	86.36	0.0034	129.54	0.0042	172.72
	2.5	0.0111	53.98	0.0066	107.95	0.0053	161.93	0.0066	214.90
8.0	2.0	0.0048	77.20	0.0029	154.32	0.0023	231.52	0.0029	308.64
	2.5	0.0075	96.50	0.0045	192.90	0.0036	289.40	0.0045	385.79
10.0	2.0	0.0036	120.92	0.0021	241.85	0.0017	362.77	0.0021	483.69
	2.5	0.0056	151.15	0.0033	302.31	0.0026	453.46	0.0033	604.61
12.0	2.0	0.0028	174.52	0.0017	349.03	0.0013	523.55	0.0017	698.07
	2.5	0.0044	218.15	0.0026	436.29	0.0021	654.44	0.0026	872.58
15.0	2.0	0.0021	275.42	0.0012	550.84	0.0010	826.26	0.0012	1101.68
	2.5	0.0032	344.28	0.0019	688.55	0.0015	1032.83	0.0019	1377.10

**TABLE 2**  
**Velocity and Flow in Cast Iron Soil Pipe Sewers and Drains**  
*(Based on Manning's Formula, With  $N = .012$ )*

Pipe Size (In.)	Slope		$\frac{1}{4}$ Full		$\frac{1}{2}$ Full		$\frac{3}{4}$ Full		Full	
	(In. Ft.)	(Ft./Ft.)	Velocity (Ft./Sec.)	Flow (Gal./Min.)	Velocity (Ft./Sec.)	Flow (Gal./Min.)	Velocity (Ft./Sec.)	Flow (Gal./Min.)	Velocity (Ft./Sec.)	Flow (Gal./Min.)
2.0	0.0120	0.0010	0.36	0.83	0.46	2.16	0.52	3.67	0.46	4.35
	0.0240	0.0020	0.51	1.18	0.66	3.06	0.74	5.18	0.66	6.15
	0.0360	0.0030	0.62	1.45	0.80	3.75	0.90	6.35	0.80	7.53
	0.0480	0.0040	0.72	1.67	0.93	4.33	1.04	7.33	0.93	8.69
	0.0600	0.0050	0.80	1.87	1.04	4.84	1.16	8.20	1.04	9.72
	0.0720	0.0060	0.88	2.04	1.13	5.30	1.27	8.98	1.13	10.65
	0.0840	0.0070	0.95	2.21	1.23	5.72	1.38	9.70	1.23	11.50
	0.0960	0.0080	1.01	2.36	1.31	6.12	1.47	10.37	1.31	12.29
	0.1080	0.0090	1.07	2.50	1.39	6.49	1.56	11.00	1.39	13.04
	0.1200	0.0100	1.13	2.64	1.47	6.84	1.64	11.59	1.47	13.75
	0.2400	0.0200	1.60	3.73	2.07	9.67	2.33	16.39	2.07	19.44
	0.3600	0.0300	1.96	4.57	2.54	11.85	2.85	20.07	2.54	23.81
	0.4800	0.0400	2.26	5.28	2.93	13.68	3.29	23.18	2.93	27.49
	0.6000	0.0500	2.53	5.90	3.28	15.29	3.68	25.92	3.28	30.74
	0.7200	0.0600	2.77	6.47	3.59	16.75	4.03	28.39	3.59	33.67
	0.8400	0.0700	2.99	6.98	3.88	18.10	4.35	30.66	3.88	36.37
0.9600	0.0800	3.20	7.47	4.14	19.35	4.65	32.78	4.14	38.88	
1.0800	0.0900	3.39	7.92	4.40	20.52	4.93	34.77	4.40	41.24	
1.2000	0.1000	3.58	8.35	4.63	21.63	5.20	36.65	4.63	43.47	
3.0	0.0120	0.0010	0.47	2.55	0.61	6.56	0.69	11.05	0.61	13.12
	0.0240	0.0020	0.67	3.61	0.86	9.28	0.97	15.63	0.86	18.55
	0.0360	0.0030	0.82	4.42	1.06	11.36	1.19	19.14	1.06	22.72
	0.0480	0.0040	0.95	5.11	1.22	13.12	1.37	22.10	1.22	26.24
	0.0600	0.0050	1.06	5.71	1.37	14.67	1.53	24.71	1.37	29.33
	0.0720	0.0060	1.16	6.25	1.50	16.07	1.68	27.07	1.50	32.13
	0.0840	0.0070	1.25	6.75	1.62	17.35	1.81	29.24	1.62	34.71
	0.0960	0.0080	1.34	7.22	1.73	18.55	1.94	31.26	1.73	37.11
	0.1080	0.0090	1.42	7.66	1.83	19.68	2.06	33.16	1.83	39.36
	0.1200	0.0100	1.50	8.07	1.93	20.74	2.17	34.95	1.93	41.49
	0.2400	0.0200	2.21	11.42	2.73	29.33	3.07	49.43	2.73	58.67
	0.3600	0.0300	2.60	13.98	3.35	35.93	3.76	60.53	3.35	71.86
	0.4800	0.0400	3.00	16.14	3.87	41.49	4.34	69.90	3.87	82.97
	0.6000	0.0500	3.35	18.05	4.32	46.38	4.85	78.15	4.32	92.77
	0.7200	0.0600	3.67	19.77	4.74	50.81	5.31	85.61	4.74	101.62
	0.8400	0.0700	3.96	21.36	5.12	54.88	5.74	92.47	5.12	109.76
0.9600	0.0800	4.24	22.83	5.47	58.67	6.13	98.85	5.47	117.34	
1.0800	0.0900	4.50	24.22	5.80	62.23	6.51	104.85	5.80	124.46	
1.2000	0.1000	4.74	25.53	6.11	65.29	6.86	110.52	6.11	131.19	



**TABLE 2 (continued)**  
**Velocity and Flow in Cast Iron Soil Pipe Sewers and Drains**  
*(Based on Manning's Formula, With  $N = .012$ )*

Pipe Size (In.)	Slope		$\frac{1}{4}$ Full		$\frac{1}{2}$ Full		$\frac{3}{4}$ Full		Full	
	(In.Ft.)	(Ft./Ft.)	Velocity (Ft./Sec.)	Flow (Gal./Min.)	Velocity (Ft./Sec.)	Flow (Gal./Min.)	Velocity (Ft./Sec.)	Flow (Gal./Min.)	Velocity (Ft./Sec.)	Flow (Gal./Min.)
4.0	0.0120	0.0010	0.57	5.45	0.74	14.08	0.83	23.63	0.74	28.12
	0.0240	0.0020	0.81	7.70	1.05	19.91	1.17	33.42	1.05	39.77
	0.0360	0.0030	0.99	9.44	1.28	24.38	1.44	40.92	1.28	48.71
	0.0480	0.0040	1.15	10.90	1.48	28.16	1.66	47.26	1.48	56.25
	0.0600	0.0050	1.28	12.18	1.65	31.48	1.85	52.83	1.65	62.88
	0.0720	0.0060	1.40	13.34	1.81	34.48	2.03	57.88	1.81	68.89
	0.0840	0.0070	1.51	14.41	1.96	37.25	2.19	62.51	1.96	74.41
	0.0960	0.0080	1.62	15.41	2.09	39.82	2.34	66.83	2.09	79.54
	0.1080	0.0090	1.72	16.34	2.22	42.23	2.49	70.88	2.22	84.37
	0.1200	0.0100	1.81	17.23	2.34	44.52	2.62	74.72	2.34	88.93
	0.2400	0.0200	2.56	24.36	3.31	62.96	3.71	105.67	3.31	125.77
	0.3600	0.0300	3.14	29.84	4.05	77.11	4.54	129.42	4.05	154.04
	0.4800	0.0400	3.62	34.46	4.68	89.04	5.24	149.44	4.68	177.86
	0.6000	0.0500	4.05	38.52	5.23	99.55	5.86	167.08	5.23	198.86
	0.7200	0.0600	4.43	42.20	5.73	109.05	6.42	183.02	5.73	217.84
	0.8400	0.0700	4.79	45.58	6.19	117.79	6.94	197.69	6.19	235.29
0.9600	0.0800	5.12	48.73	6.62	125.92	7.41	211.34	6.62	251.54	
1.0800	0.0900	5.43	51.68	7.02	133.56	7.86	224.15	7.02	266.80	
1.2000	0.1000	5.73	54.48	7.40	140.78	8.29	236.28	7.40	281.23	
5.0	0.0120	0.0010	0.67	9.94	0.86	25.71	0.96	43.15	0.86	51.37
	0.0240	0.0020	0.94	14.06	1.22	36.35	1.36	61.02	1.22	72.65
	0.0360	0.0030	1.15	17.22	1.49	44.52	1.67	74.74	1.49	88.98
	0.0480	0.0040	1.33	19.88	1.72	51.41	1.93	86.30	1.72	102.75
	0.0600	0.0050	1.49	22.23	1.92	57.48	2.15	96.49	1.92	114.87
	0.0720	0.0060	1.63	24.35	2.11	62.97	2.36	105.70	2.11	125.84
	0.0840	0.0070	1.76	26.30	2.28	68.01	2.55	114.17	2.28	135.92
	0.0960	0.0080	1.88	28.12	2.43	72.71	2.72	122.05	2.43	145.31
	0.1080	0.0090	2.00	29.82	2.58	77.12	2.89	129.45	2.58	154.12
	0.1200	0.0100	2.10	31.44	2.72	81.29	3.05	136.45	2.72	162.46
	0.2400	0.0200	2.97	44.46	3.85	114.96	4.31	192.97	3.85	229.75
	0.3600	0.0300	3.64	54.45	4.71	140.80	5.28	236.34	4.71	281.38
	0.4800	0.0400	4.21	62.88	5.44	162.58	6.09	272.91	5.44	324.91
	0.6000	0.0500	4.70	70.30	6.08	181.77	6.81	305.12	6.08	363.26
	0.7200	0.0600	5.15	77.01	6.66	199.12	7.46	334.24	6.66	397.94
	0.8400	0.0700	5.56	83.18	7.19	215.07	8.06	361.02	7.19	429.82
0.9600	0.0800	5.95	88.92	7.69	229.92	8.62	385.95	7.69	459.50	
1.0800	0.0900	6.31	94.31	8.16	243.92	9.14	409.36	8.16	487.37	
1.2000	0.1000	6.65	99.42	8.60	257.06	9.63	431.50	8.60	513.73	

**TABLE 2 (continued)**  
**Velocity and Flow in Cast Iron Soil Pipe Sewers and Drains**  
*(Based on Manning's Formula, With  $N = .012$ )*

Pipe Size (In.)	Slope		$\frac{1}{4}$ Full		$\frac{1}{2}$ Full		$\frac{3}{4}$ Full		Full	
	(In.Ft.)	(Ft./Ft.)	Velocity (Ft./Sec.)	Flow (Gal./Min.)	Velocity (Ft./Sec.)	Flow (Gal./Min.)	Velocity (Ft./Sec.)	Flow (Gal./Min.)	Velocity (Ft./Sec.)	Flow (Gal./Min.)
6.0	0.0120	0.0010	0.75	16.23	0.97	41.98	1.09	70.55	0.97	83.96
	0.0240	0.0020	1.06	22.95	1.37	59.37	1.54	99.77	1.37	118.74
	0.0360	0.0030	1.30	28.11	1.68	72.71	1.89	122.20	1.68	145.42
	0.0480	0.0040	1.50	32.46	1.94	83.96	2.18	141.10	1.94	167.92
	0.0600	0.0050	1.68	36.29	2.17	93.87	2.44	157.76	2.17	187.74
	0.0720	0.0060	1.84	39.75	2.38	102.83	2.67	172.81	2.38	205.66
	0.0840	0.0070	1.99	42.94	2.57	111.07	2.88	186.66	2.57	222.13
	0.0960	0.0080	2.13	45.90	2.75	118.74	3.08	199.55	2.75	237.47
	0.1080	0.0090	2.26	48.69	2.92	125.94	3.27	211.65	2.92	251.88
	0.1200	0.0100	2.38	51.32	3.07	132.75	3.44	223.10	3.07	265.50
	0.2400	0.0200	3.36	72.58	4.35	187.74	4.87	315.51	4.35	375.47
	0.3600	0.0300	4.12	88.89	5.32	229.93	5.97	386.42	5.32	459.86
	0.4800	0.0400	4.75	102.64	6.15	265.50	6.89	446.20	6.15	531.00
	0.6000	0.0500	5.32	114.76	6.87	296.84	7.70	498.87	6.87	593.68
	0.7200	0.0600	5.82	125.71	7.53	325.17	8.44	546.27	7.53	650.34
	0.8400	0.0700	6.29	135.78	8.13	351.22	9.11	590.27	8.13	702.45
0.9600	0.0800	6.72	145.16	8.70	375.47	9.74	631.02	8.70	750.95	
1.0800	0.0900	7.13	153.96	9.22	398.25	10.33	669.30	9.22	796.50	
1.2000	0.1000	7.52	162.29	9.72	419.79	10.89	705.51	9.72	839.59	
8.0	0.0120	0.0010	0.91	35.25	1.18	91.04	1.32	153.06	1.18	182.09
	0.0240	0.0020	1.29	49.85	1.67	128.75	1.87	216.46	1.67	257.51
	0.0360	0.0030	1.58	61.05	2.04	157.69	2.29	265.11	2.04	315.38
	0.0480	0.0040	1.83	70.50	2.36	182.09	2.64	306.12	2.36	364.17
	0.0600	0.0050	2.04	78.82	2.64	203.58	2.96	342.26	2.64	407.16
	0.0720	0.0060	2.24	86.34	2.89	223.01	3.24	374.92	2.89	446.02
	0.0840	0.0070	2.42	93.26	3.12	240.88	3.50	404.96	3.12	481.75
	0.0960	0.0080	2.58	99.70	3.34	257.51	3.74	432.92	3.34	515.02
	0.1080	0.0090	2.74	105.75	3.54	273.13	3.97	459.18	3.54	546.26
	0.1200	0.0100	2.89	111.47	3.73	287.90	4.18	484.02	3.73	575.81
	0.2400	0.0200	4.08	157.64	5.28	407.16	5.91	684.51	5.28	814.32
	0.3600	0.0300	5.00	193.06	6.46	498.66	7.24	838.35	6.46	997.33
	0.4800	0.0400	5.78	222.93	7.46	575.81	8.36	968.05	7.46	1151.62
	0.6000	0.0500	6.46	249.24	8.34	643.77	9.35	1082.31	8.34	1287.55
	0.7200	0.0600	7.07	273.03	9.14	705.22	10.24	1185.61	9.14	1410.44
	0.8400	0.0700	7.64	294.91	9.87	761.72	11.06	1280.60	9.87	1523.45
0.9600	0.0800	8.17	315.27	10.55	814.31	11.83	1369.02	10.55	1628.63	
1.0800	0.0900	8.66	334.40	11.19	863.71	12.54	1452.07	11.19	1727.42	
1.2000	0.1000	9.13	352.48	11.80	910.43	13.22	1530.61	11.80	1820.86	

**TABLE 2 (continued)**  
*Velocity and Flow in Cast Iron Soil Pipe Sewers and Drains*  
*(Based on Manning's Formula, With  $N = .012$ )*

Pipe Size (In.)	Slope		$\frac{1}{4}$ Full		$\frac{1}{2}$ Full		$\frac{3}{4}$ Full		Full	
	(In.Ft.)	(Ft./Ft.)	Velocity (Ft./Sec.)	Flow (Gal./Min.)	Velocity (Ft./Sec.)	Flow (Gal./Min.)	Velocity (Ft./Sec.)	Flow (Gal./Min.)	Velocity (Ft./Sec.)	Flow (Gal./Min.)
10.0	0.0120	0.0010	1.06	64.08	1.37	165.75	1.54	278.56	1.37	331.51
	0.0240	0.0020	1.50	90.62	1.94	234.41	2.17	393.95	1.94	468.83
	0.0360	0.0030	1.84	110.99	2.37	287.10	2.66	482.48	2.37	574.19
	0.0480	0.0040	2.12	128.16	2.74	331.51	3.07	557.12	2.74	663.02
	0.0600	0.0050	2.37	143.29	3.07	370.64	3.43	622.88	3.07	741.28
	0.0720	0.0060	2.60	156.96	3.36	406.01	3.76	682.33	3.36	812.03
	0.0840	0.0070	2.80	169.54	3.63	438.55	4.06	737.01	3.63	877.09
	0.0960	0.0080	3.00	181.24	3.88	468.82	4.34	787.89	3.88	937.65
	0.1080	0.0090	3.18	192.24	4.11	497.26	4.61	835.69	4.11	994.53
	0.1200	0.0100	3.35	202.64	4.33	524.16	4.86	880.89	4.33	1048.32
	0.2400	0.0200	4.74	286.57	6.13	741.28	6.87	1245.77	6.13	1482.55
	0.3600	0.0300	5.80	350.98	7.51	907.88	8.41	1525.75	7.51	1815.75
	0.4800	0.0400	6.70	405.27	8.67	1048.32	9.71	1761.78	8.67	2096.65
	0.6000	0.0500	7.49	453.11	9.69	1172.06	10.86	1969.73	9.69	2344.13
	0.7200	0.0600	8.21	496.36	10.62	1283.93	11.90	2157.74	10.62	2567.86
	0.8400	0.0700	8.87	536.12	11.47	1386.80	12.85	2330.62	11.47	2773.61
	0.9600	0.0800	9.48	573.14	12.26	1482.55	13.74	2491.54	12.26	2965.11
1.0800	0.0900	10.05	607.91	13.00	1572.49	14.57	2642.67	13.00	3144.97	
1.2000	0.1000	10.60	640.79	13.71	1657.55	15.36	2785.62	13.71	3315.09	
12.0	0.0120	0.0010	1.20	104.53	1.55	270.34	1.74	454.27	1.55	540.68
	0.0240	0.0020	1.69	147.83	2.19	382.32	2.45	642.43	2.19	764.63
	0.0360	0.0030	2.07	181.05	2.68	468.24	3.01	786.82	2.68	936.48
	0.0480	0.0040	2.40	209.06	3.10	540.68	3.47	908.54	3.10	1081.35
	0.0600	0.0050	2.68	233.74	3.46	604.49	3.88	1015.78	3.46	1208.99
	0.0720	0.0060	2.93	256.05	3.79	662.19	4.25	1112.73	3.79	1324.38
	0.0840	0.0070	3.17	276.56	4.10	715.25	4.59	1201.88	4.10	1430.50
	0.0960	0.0080	3.39	295.66	4.38	764.63	4.91	1284.87	4.38	1529.27
	0.1080	0.0090	3.59	313.59	4.65	811.01	5.21	1362.81	4.65	1622.03
	0.1200	0.0100	3.79	330.56	4.90	854.88	5.49	1436.53	4.90	1709.77
	0.2400	0.0200	5.36	467.48	6.93	1208.99	7.76	2031.55	6.93	2417.98
	0.3600	0.0300	6.56	572.54	8.48	1480.71	9.50	2488.14	8.48	2961.41
	0.4800	0.0400	7.58	661.11	9.80	1709.77	10.98	2873.05	9.80	3419.54
	0.6000	0.0500	8.47	739.14	10.95	1911.58	12.27	3212.17	10.95	3823.17
	0.7200	0.0600	9.28	809.69	12.00	2094.03	13.44	3518.76	12.00	4188.07
	0.8400	0.0700	10.02	874.57	12.96	2261.81	14.52	3800.69	12.96	4523.63
	0.9600	0.0800	10.71	934.95	13.86	2417.98	15.52	4063.11	13.86	4835.96
1.0800	0.0900	11.36	991.67	14.70	2564.65	16.46	4309.57	14.70	5129.30	
1.2000	0.1000	11.98	1045.31	15.49	2703.38	17.35	4542.69	15.49	5406.76	

**TABLE 2 (continued)**  
*Velocity and Flow in Cast Iron Soil Pipe Sewers and Drains*  
*(Based on Manning's Formula, With  $N = .012$ )*

Pipe Size (In.)	Slope		$\frac{1}{4}$ Full		$\frac{1}{2}$ Full		$\frac{3}{4}$ Full		Full	
	(In.Ft.)	(Ft./Ft.)	Velocity (Ft./Sec.)	Flow (Gal./Min.)	Velocity (Ft./Sec.)	Flow (Gal./Min.)	Velocity (Ft./Sec.)	Flow (Gal./Min.)	Velocity (Ft./Sec.)	Flow (Gal./Min.)
15.0	0.0120	0.0010	1.39	192.03	1.80	496.67	2.02	834.85	1.80	993.34
	0.0240	0.0020	1.97	271.58	2.55	702.40	2.86	1180.65	2.55	1404.79
	0.0360	0.0030	2.42	332.61	3.12	860.25	3.50	1445.99	3.12	1720.51
	0.0480	0.0040	2.79	384.07	3.61	993.34	4.04	1669.69	3.61	1986.67
	0.0600	0.0050	3.12	429.40	4.03	1110.58	4.52	1866.77	4.03	2221.17
	0.0720	0.0060	3.42	470.38	4.42	1216.58	4.95	2044.95	4.42	2433.17
	0.0840	0.0070	3.69	508.07	4.77	1314.06	5.35	2208.79	4.77	2628.12
	0.0960	0.0080	3.94	543.15	5.10	1404.79	5.72	2361.30	5.10	2809.58
	0.1080	0.0090	4.18	576.10	5.41	1490.01	6.06	2504.54	5.41	2980.01
	0.1200	0.0100	4.41	607.26	5.70	1570.60	6.39	2640.01	5.70	3141.21
	0.2400	0.0200	6.24	858.80	8.06	2221.17	9.04	3733.54	8.06	4442.34
	0.3600	0.0300	7.64	1051.81	9.88	2720.37	11.07	4572.64	9.88	5440.73
	0.4800	0.0400	8.82	1214.52	11.41	3141.21	12.78	5280.03	11.41	6282.41
	0.6000	0.0500	9.86	1357.88	12.75	3511.98	14.29	5903.25	12.75	7023.95
	0.7200	0.0600	10.80	1487.48	13.97	3847.18	15.65	6466.69	13.97	7694.35
	0.8400	0.0700	11.67	1606.66	15.09	4155.43	16.91	6984.82	15.09	8310.85
	0.9600	0.0800	12.47	1717.60	16.13	4442.33	18.07	7467.07	16.13	8884.66
	1.0800	0.0900	13.23	1821.78	17.11	4711.80	19.17	7920.03	17.11	9423.61
1.2000	0.1000	13.94	1920.33	18.03	4966.68	20.21	8348.44	18.03	9933.35	

ONE-QUARTER FULL\*

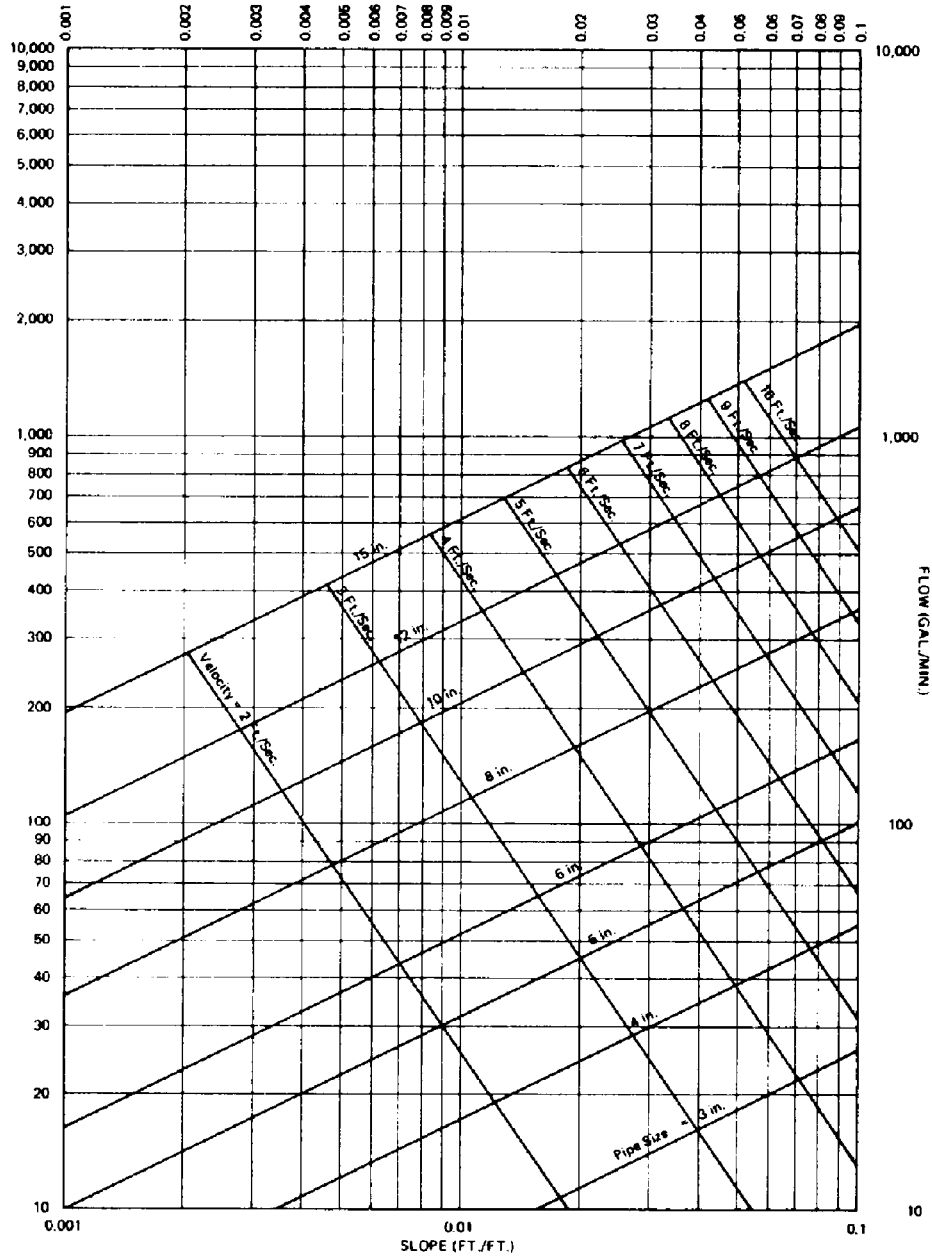

Figure 3—Velocity and Flow in Cast Iron Soil Pipe, Sewers, and Drains (Based on Manning's Formula, With n=.012).

\*Flow for 2 in. pipe size is less than 10 GPM at slopes indicated.

ONE-HALF FULL

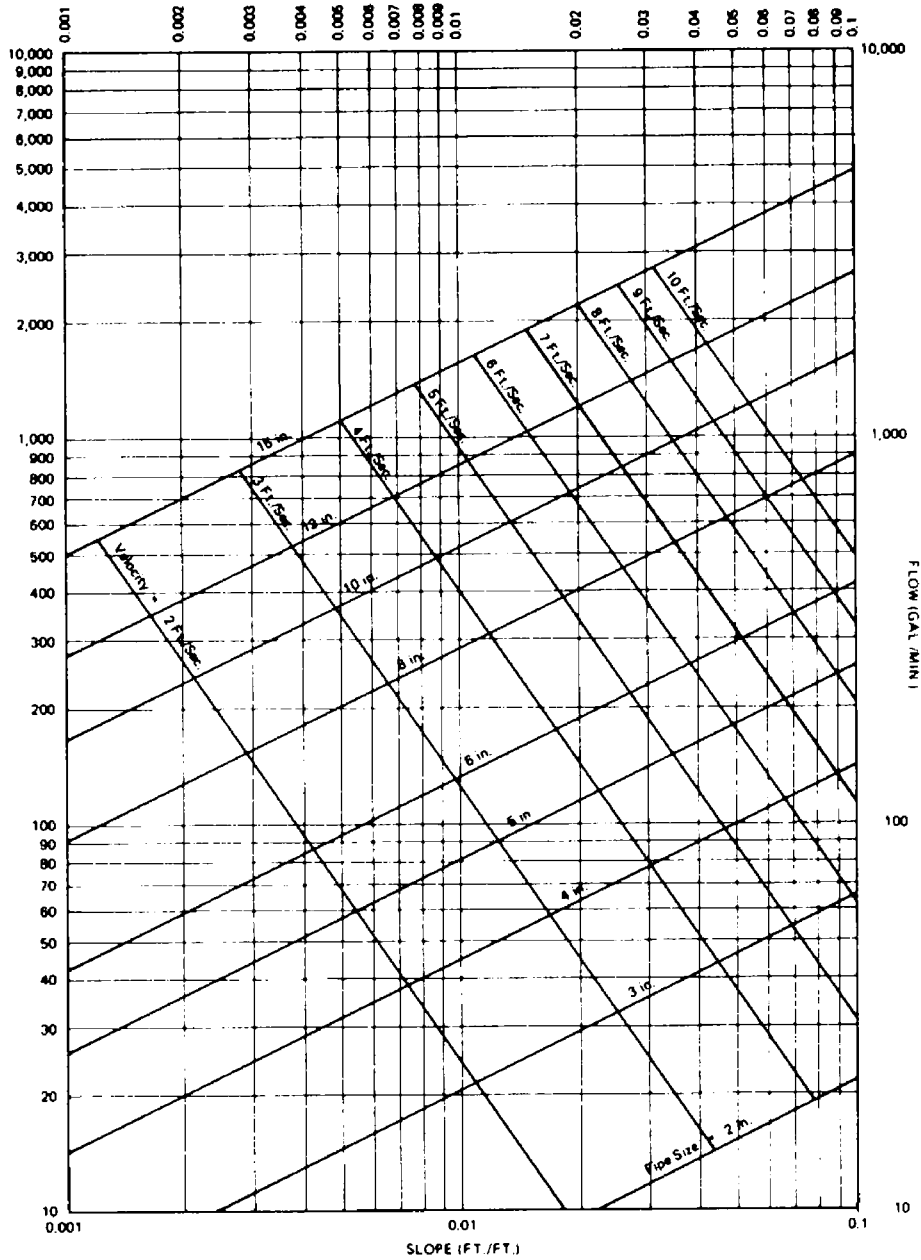

Figure 4—Velocity and Flow in Cast Iron Soil Pipe, Sewers, and Drains (Based on Manning's Formula, With n=.012).

THREE-QUARTERS FULL

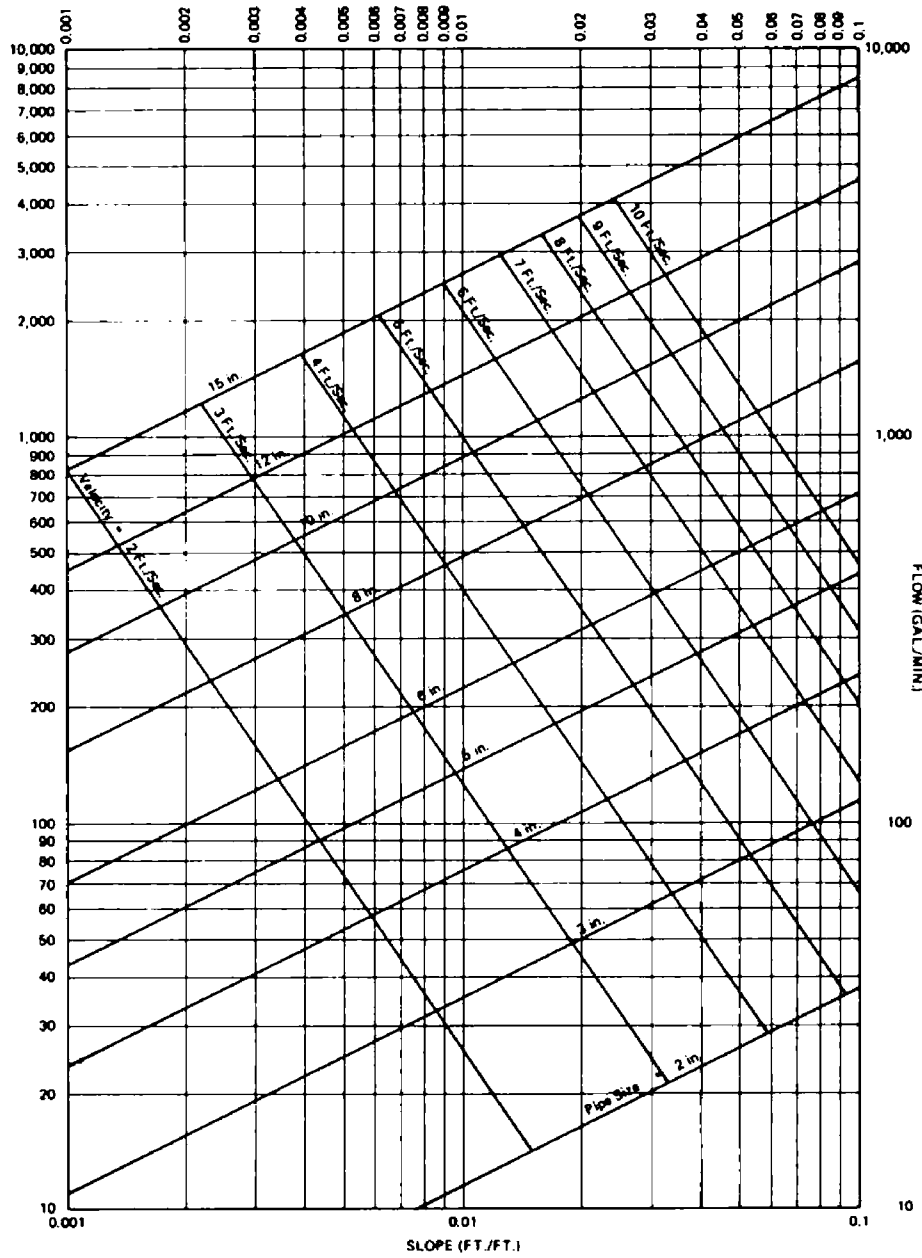

Figure 5—Velocity and Flow in Cast Iron Soil Pipe, Sewers, and Drains (Based on Manning's Formula, With  $n=.012$ ).

FULL FLOW

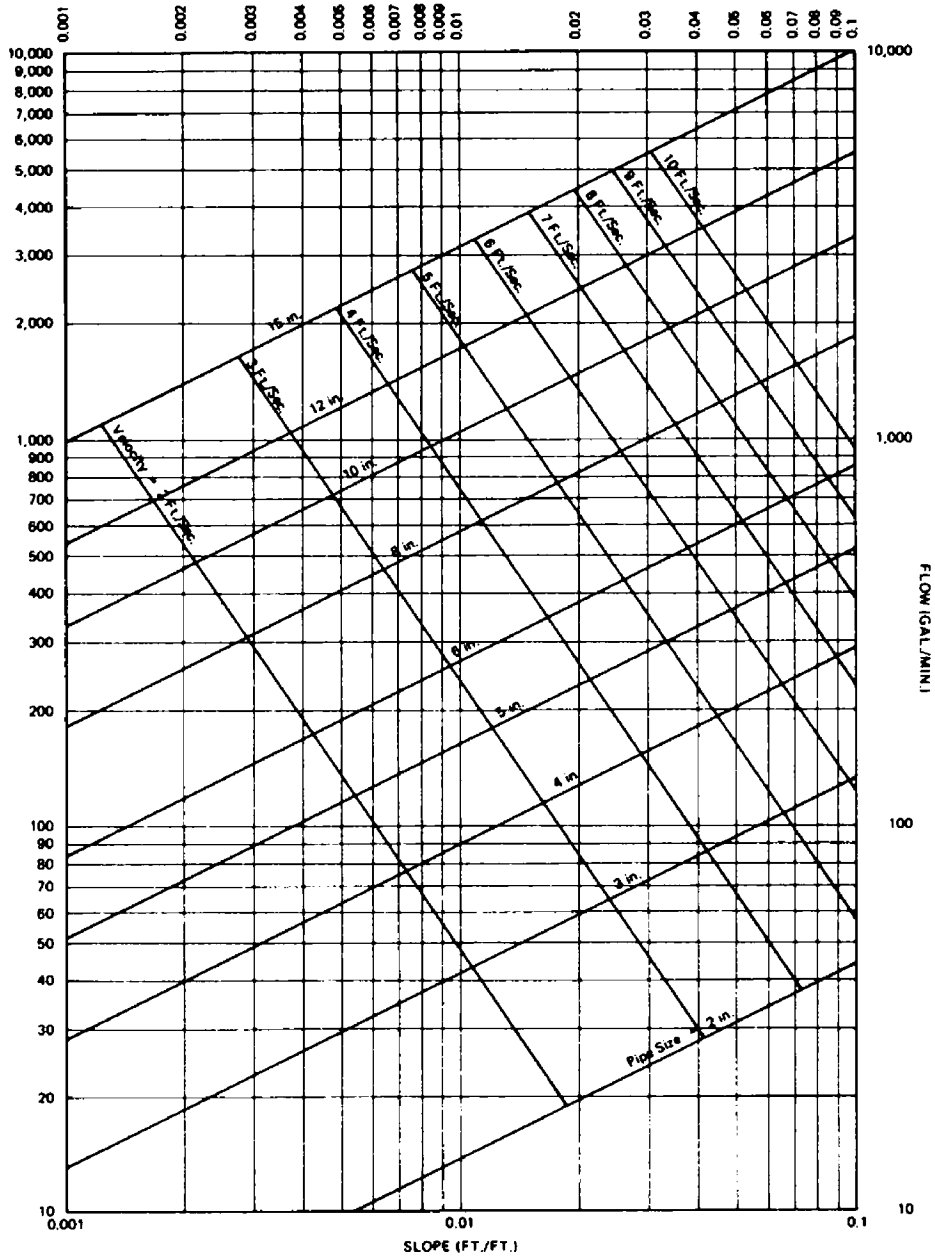

Figure 6—Velocity and Flow in Cast Iron Soil Pipe, Sewers, and Drains  
(Based on Manning's Formula, With  $n=.012$ ).



## DESIGN OF SEWERS AND DRAINS

Equation 2, Table 2, and Figures 3 through 6 provide means to insure that cast iron soil pipe is adequately sized to accommodate the expected peak flow at a designed, self-cleansing velocity. The peak flow that governs design is that projected to occur in the future during the service life of a particular system.

The factors affecting peak flow vary with the type of system to be installed. In a sanitary sewer for domestic waste, the maximum quantity of sewage depends primarily on the density and distribution of the population and its per capita use of water. In a sewer for commercial and industrial waste, it depends on the number and type of businesses to be serviced by the system. The peak load in a storm sewer, however, is determined by the duration and intensity of rainfall and the extent, condition, and slope of streets and other areas requiring drainage.

For a particular hydraulic system, the factors affecting peak flow are analyzed by means of procedures in design handbooks. Unfortunately, this analysis is generally imperfect from the standpoint of system design. In most cases, current peak flow can be accurately quantified, but only a rough approximation can be made of future peak flow, which usually is based on population trends and area development over a period of 50 years. This requires that provision be made for any unforeseen increase in runoff, and therefore cast iron soil pipe hydraulic systems are most frequently designed for half-full operation at probable future peak flow. Greater or less than half-full operation can be employed, depending on design requirements and the relative accuracy with which future flow can be forecast.

Information useful in computing flow capacities by Equation 2 is presented in Tables 3, 4, and 5. Table 3 lists values for the internal diameter of the pipe, the area of the cross section of the stream, the wetted perimeter, and the hydraulic radius. Tables 4 and 5 provide numbers to the two-thirds and one-half powers.

The following example illustrates a typical computation involving the flow capacity of a cast iron soil pipe hydraulic system: An industrial plant site is to be serviced by a cast iron soil pipe sewer that must provide a flow capacity of 1,500 gallons per minute when operating half-full. This is the peak runoff that the plant is expected to generate in the future at projected maximum levels of production. Based on the grade and condition of the ground surface under which the sewer is to be installed, as well as the location of subsurface obstructions, a system slope of 0.01 ft./ft. is planned. Initially, a 15-inch pipe size is assumed, and it must be determined whether or not this will result in an adequate flow capacity as well as an efficient operating velocity.

Given:

$$n = 0.012$$

$$D = 1.2500 \text{ ft. (See Table 3)}$$

$$a = 0.6136 \text{ sq. ft. (See Table 3)}$$

$$P = 1.9635 \text{ ft. (See Table 3)}$$

$$r = a/P = 0.3125 \text{ ft. (See Table 3)}$$

$$s = 0.01 \text{ ft./ft.}$$

Solution

$$Q = \frac{1.486}{n} ar^{2/3} s^{1/2} \quad (\text{Manning Formula} - 12)$$

$$Q = \frac{1.486}{0.012} (0.6136) (0.3125^{2/3}) 0.01^{1/2}$$

$$Q = 123.833 (0.6136) (0.4605) 0.10$$

$$Q = 123.833 (0.282563) 0.10$$

$$Q = 3.4991 \text{ cu. ft./sec.}$$

$$\text{GPM} = Q \times 7.481 \text{ Gal. per cu. ft.} \times 60 \text{ seconds} = 1570.60 \text{ gal./min.}$$

This indicates that the pipe is adequately sized to provide a capacity (Q) of 1,500 gal./min. with the system flowing half-full.

In order to determine whether the system will operate at a velocity consistent with good design (i.e., between 2 and 10 ft./sec.), the following calculation is made:

$$V = Q/a$$

$$V = 3.4991/0.6136$$

$$V = 5.70 \text{ ft./sec.}$$

Therefore, the system design provides both an adequate capacity and an efficient operating velocity.

The derivations of flow capacity and velocity made above by Equation 2 could have been obtained by referring to Table 2 or Figure 4. It will be noted that a number of possible designs frequently can be employed to satisfy a given capacity requirement, provided conditions at the construction site permit the designer latitude in selecting a system slope. The combination of pipe size and slope selected should most closely satisfy the capacity specified for the system and, if possible, also provide an efficient operating velocity.

**TABLE 3**  
*Variables Required to Solve Manning's Formula for Computing Flow Capacities of Cast Iron Soil Pipe Sewers and Drains*

Pipe Size (in.)	$1/4$ Full			$1/2$ Full			$3/4$ Full			Full			
	D	a	r	P	a	r	P	a	r	P	a	r	
2	0.1633	0.0052	0.0276	0.1886	0.0104	0.0407	0.2565	0.0157	0.0484	0.3244	0.0209	0.5130	0.0407
3	0.2466	0.0120	0.0421	0.2848	0.0239	0.0617	0.3874	0.0359	0.0733	0.4899	0.0478	0.7747	0.0617
4	0.3283	0.0212	0.0559	0.3792	0.0424	0.0821	0.5157	0.0635	0.0974	0.6522	0.0847	1.0314	0.0821
5	0.4116	0.0333	0.0700	0.4754	0.0666	0.1029	0.6466	0.0998	0.1220	0.8177	0.1331	1.2931	0.1029
6	0.4950	0.0481	0.0841	0.5717	0.0962	0.1237	0.7776	0.1443	0.1467	0.9834	0.1924	1.5551	0.1237
8	0.6616	0.0860	0.1126	0.7641	0.1718	0.1654	1.0393	0.2579	0.1962	1.3144	0.3438	2.0785	0.1654
10	0.8283	0.1347	0.1408	0.9567	0.2694	0.2071	1.3011	0.4041	0.2456	1.6455	0.5388	2.6022	0.2071
12	0.9950	0.1944	0.1692	1.1492	0.3888	0.2488	1.5630	0.5832	0.2950	1.9767	0.7776	3.1259	0.2488
15	1.2500	0.3068	0.2125	1.4438	0.6136	0.3125	1.9635	0.9204	0.3707	2.4832	1.2272	3.9270	0.3125

D = internal pipe diameter (ft.)  
a = area of cross section of stream (sq. ft.)  
P = wetted perimeter (ft.)  
r = a/P = hydraulic radius (ft.)

**TABLE 4**  
*Numbers to the Two-Thirds Power Used to Obtain  $r^{2/3}$  in Manning's Formula*

No.	.00	.01	.02	.03	.04	.05	.06	.07	.08	.09
.0	.000	.046	.074	.097	.117	.136	.153	.170	.186	.201
.1	.215	.229	.243	.256	.269	.282	.295	.307	.319	.331
.2	.342	.353	.364	.375	.386	.397	.407	.418	.428	.438
.3	.448	.458	.468	.477	.487	.497	.506	.515	.525	.534

**TABLE 5**  
*Number to the One-Half Power Used to Obtain*  
 *$s^{1/2}$  in Manning's Formula*

No.	--- 0	--- 1	--- 2	--- 3	--- 4	--- 5	--- 6	--- 7	--- 8	--- 9
.00001	.003162	.003317	.003464	.003606	.003742	.003873	.004000	.004123	.004243	.004359
.00002	.004472	.004583	.004690	.004796	.004899	.005000	.005099	.005196	.005292	.005385
.00003	.005477	.005568	.005657	.005745	.005831	.005916	.006000	.006083	.006164	.006245
.00004	.006325	.006403	.006481	.006557	.006633	.006708	.006782	.006856	.006928	.007000
.00005	.007071	.007141	.007211	.007280	.007348	.007416	.007483	.007550	.007616	.007681
.00006	.007746	.007810	.007874	.007937	.008000	.008062	.008124	.008185	.008246	.008307
.00007	.008367	.008426	.008485	.008544	.008602	.008660	.008717	.008775	.008832	.008888
.00008	.008944	.009000	.009055	.009110	.009165	.009220	.009274	.009327	.009381	.009434
.00009	.009487	.009539	.009592	.009644	.009695	.009747	.009798	.009849	.009899	.009950
.00010	.010000	.010050	.010100	.010149	.010198	.010247	.010296	.010344	.010392	.010440
.0001	.01000	.01049	.01095	.01140	.01183	.01225	.01265	.01304	.01342	.01378
.0002	.01414	.01449	.01483	.01517	.01549	.01581	.01612	.01543	.01673	.01703
.0003	.01732	.01761	.01789	.01817	.01844	.01871	.01897	.01924	.01949	.01975
.0004	.02000	.02025	.02049	.02074	.02098	.02121	.02145	.02168	.02191	.02214
.0005	.02236	.02258	.02280	.02302	.02324	.02345	.02366	.02387	.02408	.02429
.0006	.02449	.02470	.02490	.02510	.02530	.02550	.02569	.02588	.02608	.02627
.0007	.02646	.02665	.02683	.02702	.02720	.02739	.02757	.02775	.02793	.02811
.0008	.02828	.02846	.02864	.02881	.02898	.02915	.02933	.02950	.02966	.02983
.0009	.03000	.03017	.03033	.03050	.03066	.03082	.03098	.03114	.03130	.03146
.0010	.03162	.03178	.03194	.03209	.03225	.03240	.03256	.03271	.03286	.03302
.001	.03162	.03317	.03464	.03606	.03742	.03873	.04000	.04123	.04243	.04359
.002	.04472	.04583	.04690	.04796	.04899	.05000	.05099	.05196	.05292	.05385
.003	.05477	.05568	.05657	.05745	.05831	.05916	.06000	.06083	.06164	.06245
.004	.06325	.06403	.06481	.06557	.06633	.06708	.06782	.06856	.06928	.07000
.005	.07071	.07141	.07211	.07280	.07348	.07416	.07483	.07550	.07616	.07681
.006	.07746	.07810	.07874	.07937	.08000	.08062	.08124	.08185	.08246	.08307
.007	.08367	.08426	.08485	.08544	.08602	.08660	.08718	.08775	.08832	.08888
.008	.08944	.09000	.09055	.09110	.09165	.09220	.09274	.09327	.09381	.09434
.009	.09487	.09539	.09592	.09644	.09695	.09747	.09798	.09849	.09899	.09950
.010	.10000	.10050	.10100	.10149	.10198	.10247	.10296	.10344	.10392	.10440
.01	.1000	.1049	.1095	.1140	.1183	.1225	.1265	.1204	.1342	.1378
.02	.1414	.1449	.1483	.1517	.1549	.1581	.1612	.1643	.1673	.1703
.03	.1732	.1761	.1789	.1817	.1844	.1871	.1897	.1924	.1949	.1975
.04	.2000	.2025	.2049	.2074	.2098	.2121	.2145	.2168	.2191	.2214
.05	.2236	.2258	.2280	.2302	.2324	.2345	.2366	.2387	.2408	.2429
.06	.2449	.2470	.2490	.2510	.2530	.2550	.2569	.2588	.2608	.2627
.07	.2646	.2665	.2683	.2702	.2720	.2739	.2757	.2775	.2793	.1811
.08	.2828	.2846	.2864	.2881	.2898	.2915	.2933	.2950	.2966	.2983
.09	.3000	.3017	.3033	.3050	.3066	.3082	.3098	.3114	.3130	.3146
.10	.3162	.3176	.3194	.3209	.3225	.3240	.3256	.3271	.3286	.3302

# CHAPTER IX

## WHY YOU NEED TO SPECIFY CAST IRON PLUMBING FOR YOUR HOME

For most of us, the biggest investment we will make in our lifetime is the purchase of a new house or condominium. Whether constructing a new dwelling or altering an existing living space, new homeowners in the know are asking more and more questions about the materials in their new construction.

Today's homeowner is inquisitive about options such as windows, plumbing fixtures, and interior decorating themes. The value-conscious homeowner is also looking beyond the frills and also asks questions about the mechanical, plumbing, and electrical systems.

Homeowners realize that these hidden systems, which provide for today's living comfort, are not all the same. Insistence on different electrical outlets, heating equipment, and plumbing products is often the result of prior unsatisfactory experiences. This may be from reading about or watching television shows such as 60 Minutes, which focused on failures of plastic piping. Astute owners no longer accept any old "guts" in their new dwelling simply because someone obtained a "deal" on the material.

We suggest that you focus attention on the choices when selecting a cast iron soil pipe drain, waste, and vent (DWV) system (the permanent and crucial system that conveys wastewater from the house across the property line to the city sewers and vents the plumbing system gases to the atmosphere).

Before 1970 most drain, waste, and vent (DWV) systems used cast iron pipe and fittings. Since then, many homes have been constructed using plastic (ABS or PVC) piping systems. Because the DWV systems are hidden behind the walls, as illustrated in Figure 1, most homeowners do not know the kind of pipe they have.



Figure 1—Cast Iron in Residential Application.

Many builders and homeowners have become aware of the noise problems associated with plastic piping systems. Because of this problem, cast iron is now specified due to its superior sound suppression. This time proven material is today’s choice for custom residences.

**WHY CAST IRON?**

For centuries cast iron pipe and fittings have been used to convey waste and water throughout the western world. Cast iron pipe installed at the fountains of Versailles in 1623 is still functioning today. Cast iron plumbing installed in the White House in the 1800s still functions flawlessly. Reliable cast iron has proven its worth over the years in demanding applications, a historical track record unmatched by substitute materials.

*The Quiet Pipe®*

Cast iron is known for quiet operation. Studies done by the Cast Iron Soil Pipe Institute have shown that cast iron soil pipe and fittings, because of their dense molecular structure and rubber gasket joints, are 750 percent more effective in reducing plumbing noise than substitute materials. (See Figure 2.) The owner of today’s \$500,000 house will not tolerate the noise of wastewater gushing down the living room walls through plastic piping materials when the quiet alternative, cast iron, is so readily available.

*Ease of Installation*

Did you know that cast iron often outlasts the building? Today’s cast iron systems use compression gaskets and couplings, which are easy to alter in case of a future modification. With plastic solvent-cemented systems, piping has to be cut out and thrown away if mistakes are made or alterations are necessary. Some people are unaware that No Hub (hubless) cast iron systems fit in modern stud walls just as easily as plastic systems (in fact they take up slightly less space).

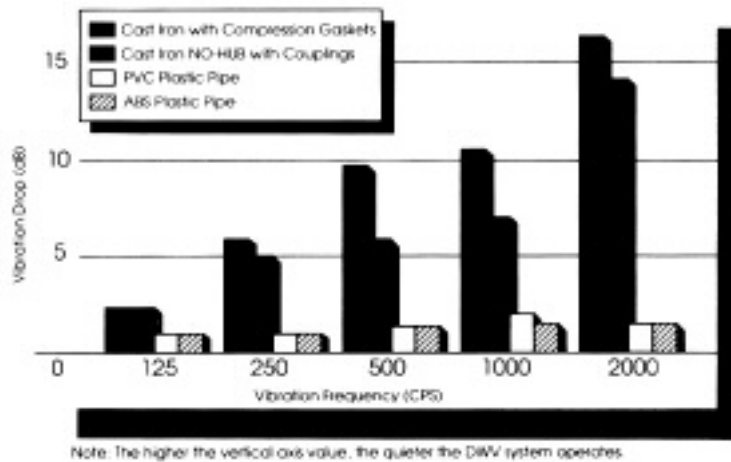

Taller bars indicate quieter system operation.

Figure 2—Noise Muffling Qualities of DWV Materials.

### *Strength, Durability, and Safety*

In terms of strength, none of the substitute materials exhibit the strength of cast iron. Thin-wall plastics such as ASTM D3034 lack the strength for under-foundation installation. In terms of crush strength, buried cast iron is ten times stronger than some of today's thermoplastic materials, which should only be installed in accordance with ASTM D2321. With cast iron, your piping has high crush strength and resistance to tree roots, penetration by rodents, and failure because of ground shifts. Unlike plastic pipe, no special bedding is required to support the pipe. As well, the thermal expansion and contraction of cast iron is far less than that of competing materials. Failures from expansion and contraction due to extreme cold and heat are virtually impossible.

Cast iron is permitted in all national plumbing standards and, therefore, will meet all local codes. From a safety and liability standpoint, it is the safest plumbing material because it will not burn or produce toxic gases.

### *Environmentally Friendly*

Finally, cast iron pipe and fittings are environmentally sensitive. Made from recycled scrap iron and steel, soil pipe and fittings represent a savings to our environment. Companies producing soil pipe and fittings are leaders in environmental control technology and have been energy conscious and ecologically aware for decades.

### *Cost Myths*

There are several myths concerning cast iron soil pipe and fittings: The first involves cost and is a common objection raised by contractors or builders. They often cite to the homeowner that cast iron plumbing will drastically increase the price of the drainage system. Based on recent studies, the



Figure 4—Assembling Hubless Cast Iron Soil Pipe Is Literally a Snap.  
Only Two Tools Are Required, a Pipe Cutter and Torque Wrench.

wholesaler cost differential between cast iron drainage and/or vent stacks and their plastic counterparts amounted to less than \$150 per bathroom.<sup>1</sup>

As a homeowner, what you need to ask is “Can I give up my peace and quiet for this small price difference?” Perhaps a better perspective is obtained by dividing \$150 by the total cost of your home. The resulting percentage will be minor in the overall project budget. Continuing quiet operation of your drainage system is of far greater value. For builders, the quiet system is a strong selling feature; for a homeowner, it can be an important selling tool in an eventual resale.

### *Availability Myths*

Other myths about cast iron are that it is not available and is difficult to install. Not true: The industry includes modern, well-capitalized producers located strategically across the United States. There are almost no locations in America more than two days from foundry sites. (See Figure 3.) Furthermore, most plumbing wholesalers stock cast iron soil pipe and fittings or have access to the manufacturers. Because cast iron is so widely used in the United States, most plumbers are very familiar with its installation. Ongoing plumber apprentice training continues to teach the installation of soil pipe and fittings as an essential component of its educational programs.

### *The Best Value*

We are happy that you took the time to learn more about why you should specify cast iron—the DWV material of choice—for your new home or remodeling project. Safe, time proven, quiet, and durable; you can rest assured that your plumbing performance will be flawless with a cast iron system. You will be glad that you took the time to specify a product of long-lasting value to you and your family—**Cast Iron Soil Pipe**.



Figure 3—Readily Available Inventory.

<sup>1</sup>Pricing reflects a range of differentials in actual wholesaler costs between cast iron and plastic pricing. Later trade markups are not included. Design or code requirements may differ from the model used.



# CHAPTER X

## ADVANTAGES OF SPECIFYING CAST IRON SOIL PIPE FOR A QUALITY PLUMBING SYSTEM

Throughout the years engineers, inspectors, installers, and building owners have recognized cast iron as the best material for use in drainage, waste, vent, and storm piping applications. There have been many different alternative materials utilized in these systems with varying degrees of success, but cast iron has remained the industry standard.

### CAST IRON—THE QUIET PIPE®

A number of studies have been performed to determine the effectiveness of cast iron soil pipe versus other materials as a noise suppressant in DWV systems. Two of the most important and conclusive test programs are discussed below. First, the principal conclusions of the respective studies and their recommendations are presented, followed by a detailed discussion of installation requirements for achieving quiet DWV systems.

A two-year research and testing program, conducted by Polysonics Acoustical Engineers, in Washington, D.C., to determine the acoustical characteristics of different materials commonly used in drainage, waste, and vent systems reached the conclusion that only cast iron soil pipe systems, with their high mass and resilient neoprene-sealed joints, are quiet enough to meet today's demands for low noise levels in homes, apartments, and commercial buildings. Polysonics' published report of the test results and evaluation<sup>1</sup> is a useful tool for the architect, engineer, and plumbing contractor to fulfill their clients' demands for noise control and acoustical privacy.

In a separate, more recent study MJM Acoustical Consultants was retained by the Cast Iron Soil Pipe Association to study the noise emitted by three-inch diameter cast iron, PVC, and ABS DWV pipes installed in a typical building. This study establishes clearly that DWV pipes made of cast iron are quieter than PVC pipes (by 6–10 dBA<sup>1</sup>, with an average difference of 8 dB) and ABS pipes (by as much as 15 dBA) whether pipes are open or enclosed by drywall.

### NOISE, ITS MEASUREMENT AND CONTROL

Noise is often defined as unwanted sound, and reaction to it is largely subjective. Sound is usually measured in decibels; one decibel is the faintest sound detectable by the human ear. For a change in sound to be clearly discernible, an increase or decrease of three decibels is usually required. Intensity, frequency, and quality or character are the dimensions of sound.

The public, increasingly aware of excessive environmental noise, demands greater acoustical privacy at home and at work. Human reaction to noise is determined by the intensity or loudness of the sound (measured in decibels), by its frequency or pitch, and by its duration or time pattern. These must all be considered in determining the “noise criteria” or acceptable noise level for any area.

<sup>1</sup> Polysonics Acoustical Engineers, *Noise and Vibration Characteristics of Soil Pipe Systems* (Job No. 1409, Report No. 1578 for the Cast Iron Soil Pipe Institute), Polysonics Acoustical Engineers, June, 1970.

To create an appropriate acoustical environment, noise criteria curves have been developed to express these factors scientifically in a single noise criteria, or NC, number. These curves serve as a precise design tool and provide guidelines to determine acceptable noise levels for interior spaces. (See Figure 1.) By using Figure 1, the engineer may choose the noise reduction factor for structural components and mechanical equipment.

Traditionally, the large mass of building materials has served as a barrier to sound transmission in buildings. Yet the same solid walls, floors, and double windows that help reduce the transmission of outside noise into the structure also may be a factor in retaining and transmitting noise and vibrations created within the structure. Further contributing to the transmission of noise are advances in material technology that have enabled us to use lighter and stronger “engineered” materials. The substitution of lighter materials has greatly contributed to the transmission of sound from the mechanical systems to occupied areas. The transmission of excessive noise has been found to be a significant factor in the occupant’s perception of quality and the owner’s perception of value.

**PIPE MATERIALS AND THE CONTROL OF PLUMBING NOISE**

Of all the acoustical problems that plague the builder and designer, plumbing noise is among the most serious. Because noisy plumbing systems produce some of the most difficult noise problems to solve in homes and other buildings, specifiers need precise information to help them select pipe materials most likely to produce a quiet drain, waste, and vent system.

The conventional considerations in specifying pipe include such variables as the initial cost of materials, installation and labor cost, potential operating problems, repairs, and pipe life. These considerations interact with each other; for example, an advantage in the basic materials cost for a partic-

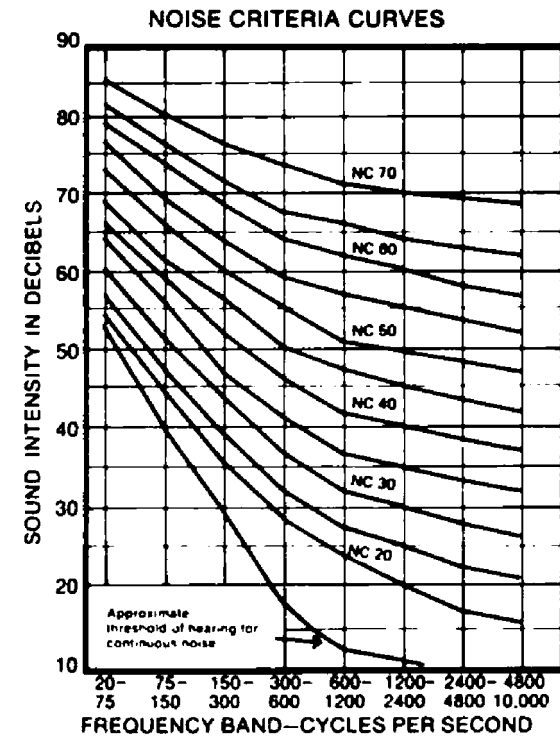

Each NC curve connects points of equal acceptability

Figure 1—Recommended Noise Criteria for Rooms.

ular system may be offset by its higher installation cost. Ease in making changes or additions once piping has been installed may be an advantage on one job but not on another. A requirement for noise and vibration control is often added to these various considerations.

The Polysonics study included both laboratory and field tests to objectively determine the vibration and noise-transmission characteristics of the following major DWV systems: cast iron soil pipe joined by three different methods (lead and oakum, neoprene compression gasket, and hubless coupling with neoprene gasket);<sup>2</sup> two types of plastic piping with cemented joints; copper pipe with soldered joints; and galvanized steel pipe with threaded joints. The tests demonstrated that cast iron soil pipe sealed with neoprene gaskets provides the quietest DWV system.

Because of its high mass, cast iron has inherent noise-dampening qualities that make it preferable to lighter materials. The Polysonics report indicates that high-mass cast iron soil pipe is harder to excite into vibration than other DWV piping. Further, control of plumbing system noise depends on the mass of the pipe wall. With the exception of lead, cast iron is the highest density material used as a DWV piping material. The advantage of cast iron is augmented by the use of resilient neoprene seals in either the compression gasket or the hubless joint. The density of cast iron combined with the isolating qualities of neoprene make cast iron soil pipe the quietest of all DWV piping materials. (See Figure 2.)

### *Test Methods*

In the laboratory, Polysonics prepared two mockup installations for each of the seven DWV systems tested, one using two-inch diameter pipe, the other using four-inch diameter pipe. The test rigs, built in a Z configuration (See Figures 3), were subjected to a vibration source (transducer), and measurements were then made of vibration levels at various points along the pipe. Measurements were taken at octave bands centered at 125, 250, 500, 1,000, and 2,000 cycles per second. These points were chosen because they cover the range of frequencies of most pipe-carried noise problems, including water flow, flush, and vibration from disposers and other machinery. Over 8,500 data points were recorded and analyzed during the laboratory study, and its findings were then corroborated by additional tests conducted on actual cast iron soil pipe DWV installations in high-rise buildings. These field tests showed close correlation with the laboratory test results.

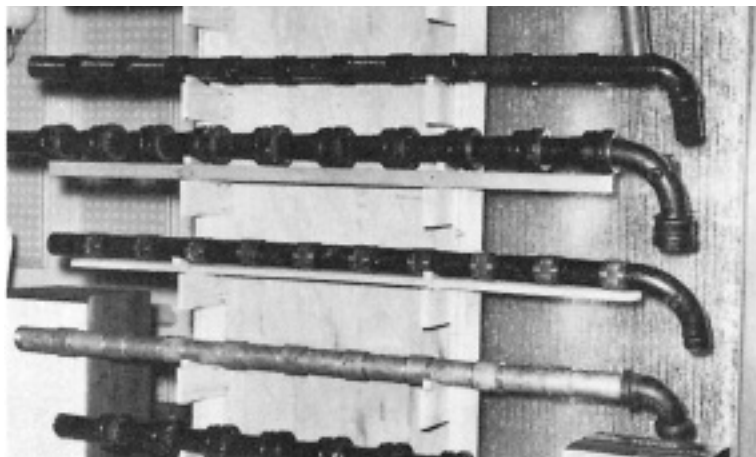

Figure 2—Test Rigs With Only One Bend Were Developed for Demonstration and Lecture Purposes.

<sup>2</sup>The Polysonics Study was conducted using hubless couplings of a design for which CISPI previously held patent rights.



Figure 2—“Z” Rig Configurations Used in Development of All Laboratory Data.



Figure 3—A “Z” Rig Being Tested for Acoustical Characteristics (Cast Iron with Neoprene Compression Gaskets).

### *Test Results*

As Figures 5(a) through 5(f) indicate, data recorded on all pipe systems except those sealed with neoprene gaskets showed essentially no reduction in vibration in straight piping runs. The two cast iron soil pipe systems sealed with neoprene gaskets showed a substantial overall vibration reduction across each joint (as high as 20 dB per joint). The significance of these test results to builders and designers is stated by the Polysonics' report in the following conclusions:

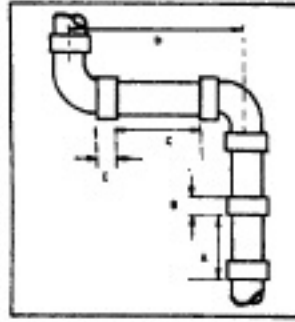

Detail of wet legs

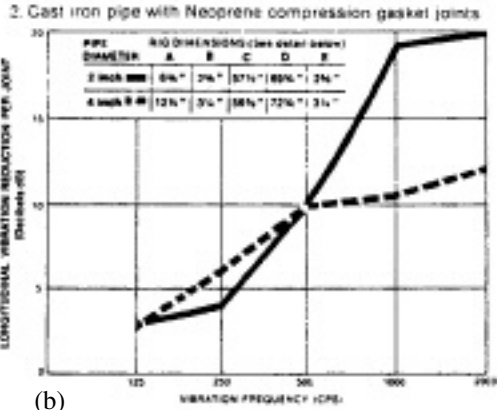

(b)

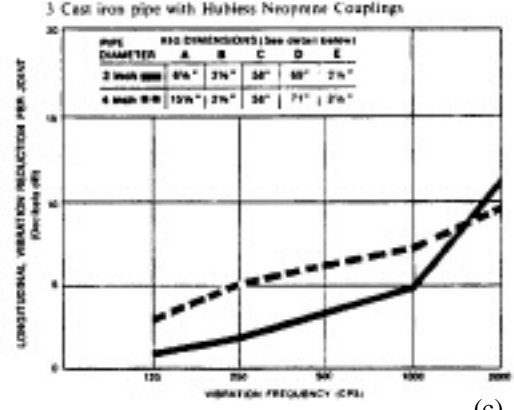

(c)

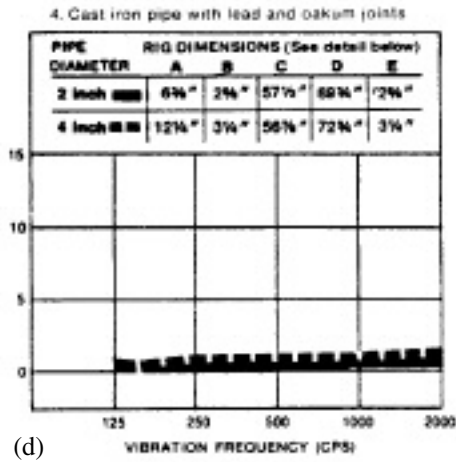

(d)

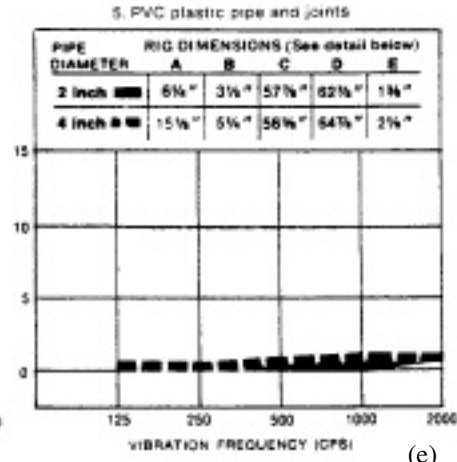

(e)

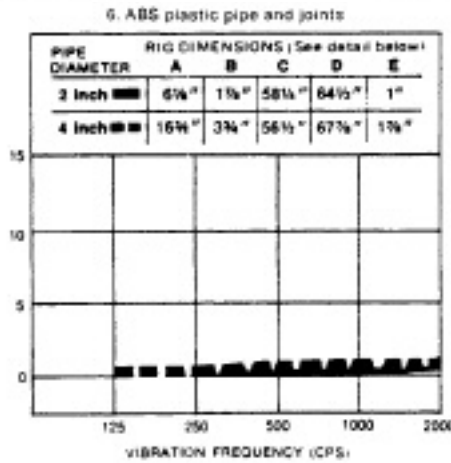

(f)

Figure 5—Vibration Drops Across the Pipe Joints of Six DWV Systems.

- Cast iron soil pipe/neoprene gasket systems can provide substantial vibration and noise drops over even a few joints, such as occur in back-to-back bathrooms, thus providing quiet waste pipe systems for areas in very close proximity.
- Lightweight systems such as copper, ABS, and PVC plastic transmit vibration and noise, and therefore should not be used where quiet waste pipe systems are required.

Figure 5 shows vibration drops across the pipe joints; thus, the steeper the curve, the less noise transmitted along the pipe run. Airborne noise (transmitted directly through the pipe wall) is controlled by the mass of the piping material. Cast iron soil pipe systems, with their heavy mass, have always been the quietest in this respect.

“In summation,” states Polysonics, “the intrinsic quietness of heavy-mass cast iron soil pipe, established through many years of use in home and high-rise construction, is now greatly enhanced by the use of resilient neoprene gaskets as joint seals.”

### *The Role of Neoprene in Plumbing Noise Reduction*

In analyzing reasons for the success of neoprene joint seals in reducing noise transmission, it was determined that both the compression gasket and the hubless system provide a positive isolation break at every joint by preventing direct metal-to-metal contact. (See Figures 6 and 7.) The neoprene compression gasket is inserted into the pipe hub, where it seats positively within the grooves. The male spigot end is inserted into the gasket, and the gasket thus effectively isolates the two pipes from each other.

With the hubless system, the center stop of the neoprene sleeve prevents direct metal-to-metal contact between the two plain-end pipes. The sleeve is secured with a stainless steel screw-band clamp, tightened with a simple torque wrench. Thus, in both systems an isolation break is provided at every joint.

In testing the various soil pipe systems, Polysonics drew distinctions between airborne and structurally borne vibration. Structurally borne vibration occurs where the pipe touches plaster or drywall, ceilings, and/or floors. Walls, ceilings, and floors are readily excited and radiate the vibration as airborne noise. Proper isolation of the pipe system therefore is another important factor in reducing plumbing noise.

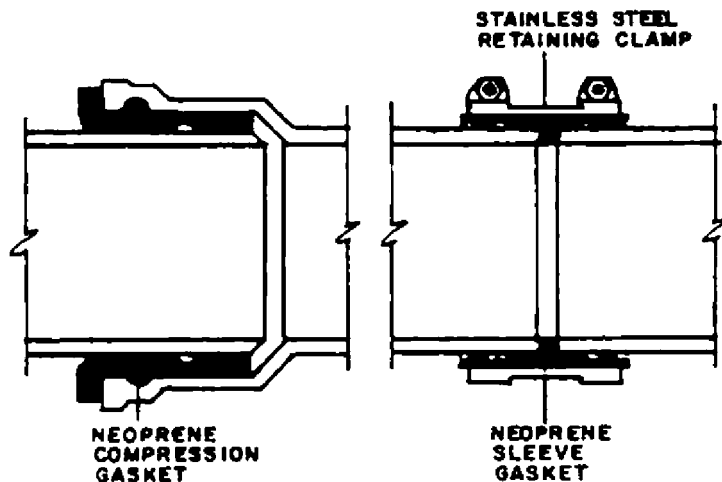

Figure 6—Isolation Breaks in Cast Iron Soil Pipe Systems With Neoprene Joint Seals.



Figure 7—Testing a Hubless System.

Neoprene's value as an isolating material has long been recognized by acoustical engineers. This synthetic rubber is widely used for engine mounts and pads under noise-producing machinery such as pumps, chiller-compressors, fans, and other equipment. The material isolates vibration because it exhibits excellent dampening qualities. Dampening helps to reduce the vibration that is otherwise radiated as airborne noise. Neoprene also isolates the high-frequency noises heard most often by humans.

### **MJM ACOUSTICAL CONSULTANTS**

MJM Acoustical Consultants, Inc., was retained by the Canadian Cast Iron Soil Pipe Association to conduct a research project on the noise produced by several three-inch diameter DWV pipes made of cast iron, PVC, and ABS, respectively. The experimental setup used for this study was typical of a DWV pipe installation found in most North American single- or multidwelling homes: A water closet discharging into a three-inch horizontal waste pipe connected to a three-inch vertical waste stack, enclosed in a wall constructed of  $\frac{5}{8}$  inch gypsum board. The objective of the project was to study the noise emitted by DWV pipes installed in a typical building.

#### ***Test Method***

During the course of this research project, eight series of acoustical measurements were conducted on eight types of North American DWV pipes: four with cast iron soil pipes, three with PVC pipes, and one with ABS pipes. All the pipes were installed in identical physical configurations and tested in the same acoustical conditions, strictly following the same procedure to allow for direct comparison of the sound pressure levels emitted by each pipe during a 1.6-gallon (6-liter) water closet flush.

- The background noise in the 90 m<sup>3</sup> reverberation chamber in which the pipes were installed was monitored to ensure that it was always 10 dB below the noise radiated by unenclosed pipes for frequencies above 125 Hz; in the case of enclosed pipes, especially at high frequencies, the noise radiated by the pipes was not always 10 dB higher than the background noise.
- For each type of pipe under test, a demonstration was made that the noise measured in the 90 m<sup>3</sup> room was exclusively radiated from the pipes under test and that there was no contribution resulting from airborne noise transmission from one chamber to another, which could have altered the measurement results for the frequency range selected.
- Repeatability and reproducibility tests have been conducted on each type of pipe under test.

Table 1 below is a summary of the overall noise levels in dBA emitted by each type of pipe while evacuating a 1.6-gallon (6 liter) water flush in the four configurations for which the tests were conducted.

The MJM Acoustical Consultants test results confirm the advantages of pipe-material mass and neoprene joints in controlling noise in DWV systems. The MJM test results also demonstrate two other important conclusions:

*Noise is Generated in Both Vertical and Horizontal DWV Piping*

For several years quality-minded contractors have used combination DWV systems to keep to a minimum the noise generated by the DWV systems in the houses they build. Most will use cast iron for all of the “wet” piping and use a less expensive material for the vent piping only. In many cases, however, cast iron was chosen for use only on the main stack that passes through the wall from the upstairs to the downstairs. The less-expensive material was used not only for the vent piping but also for the laterals that branch off of the stack to serve upstairs fixtures such as water closets, tubs, and lavatories.

Many plumbing designers have long believed that the majority of the noise in DWV systems is created in the vertical stack, where the waste flow is turbulent. The horizontal branch lines serving individual fixtures were not considered significant components in the generation of noise because

**TABLE 1**  
**Overall “A” Weighted Sound Pressure Level**  
**Radiated by Pipe Assemblies Tested**

Type of Pipe	Global Sound Pressure Level (dBA, ref 20 microPa)			
	Bare pipes	Enclosed pipes	Vertical pipe unenclosed	Horizontal pipe unenclosed
XH (extra heavy) – ASTM A74	40	24	39	32
No-Hub Long – CISPI 301, CSA B70	42	25	41	36
No-Hub Short – CISPI 301, CSA B70	41	24	40	36
SV (service) – ASTM A74	43	26	41	39
System 15 (solid wall)	49	32	42	48
PVC 7300 – ASTM D2665 (solid wall)	48	33	43	47
PVC 4300 – ASTM F891 (cellular core)	51	34	45	48
ABS 3300 – ASTM F628 (cellular core)	55	39	49	54
Average Cast Iron	41	25	40	36
Average PVC	49	33	43	48



these lines are smaller than the stack, and one would not suspect that the lateral flow of waste would generate significant noise compared to that same waste cascading down the vertical stack.

By testing vertical and horizontal piping installations separately, MJM Acoustical Consultants isolated the piping components and measured the noise generated in each. The results, in Table 1, demonstrate a very interesting phenomenon: The difference in noise levels between cast iron and plastic installed in the vertical position is 3 dB. The difference in noise levels between cast iron and plastic installed in a horizontal position is a full 12 dB. The test results demonstrate that substituting cast iron for plastic in the horizontal runs is 400 percent more effective in controlling plumbing noise than the same substitution in the vertical stack.

### *Drywall Does Not Solve Plumbing Noise Problems*

A common misconception is that once the piping enclosed by drywall, the noise will not be as bad. Although the test results do show that drywall reduces noise by 16 dB in both cast iron and plastic systems, they also demonstrate that the difference in noise levels between cast iron and plastic systems remains identical at 8 dB. The remaining 33 dB noise level of the plastic is often exacerbated in the field because a 3 inch plastic stack has a larger outside diameter, which frequently causes it to come into contact with the drywall on both sides of a 2 X 4 wall. If the pipe material is allowed to touch the drywall, the noise from the pipe will be transmitted to the drywall, making the noise far more noticeable. Cast iron soil pipe, however, will fit inside a 2 X 4 wall without touching the drywall on either side.

### *Writing Specifications for Quiet DWV Systems*

In writing specifications for the installation of a quiet drainage, waste, and vent system, the following requirements must be clearly spelled out:

- The pipe material should have a low coefficient of sound transmission and must also meet all applicable codes and serve the purpose for soil, waste, venting, and storm drainage. Cast iron soil pipe is superior for these purposes.
- When joining pipe and fittings, a material with good sound absorbing qualities should be specified. Such a material will help insulate and isolate each succeeding piece of pipe. Neoprene gaskets are recommended, either the compression gasket type or the hubless neoprene coupling.
- The materials used should conform to all appropriate standards and specifications.
- Proper methods of support must be provided, with hangers or hanger materials that will not transmit noise from the building structure to the pipe, or from the pipe to the building structure.

## **CAST IRON—THE GREEN PIPE**

### *What Makes a Building “Green”?*

During building construction and operation, natural resources are consumed. Trees and minerals are taken from the earth to produce building materials, and fossil fuels are burned to heat or cool a building, all of which can negatively impact the environment. Fortunately, a group of environmentalists studied the problem and developed a solution. They established a group of practices for “green” buildings. In this case, the term “green” is used to indicate that the design, construction, and operation of buildings minimize their negative impact on the environment. Federal, state, and local gov-

ernments, as well as individual building owners, have embraced “green” building practices because they believe that expansion of our built environment should not necessarily come at the expense of our natural environment. Today “green” building practices are receiving substantial support throughout the construction industry.

There are many factors that must be considered when evaluating the environmental sustainability of a building. Some of the more important factors include energy conservation, site development, water conservation and recycling, indoor environmental quality, and materials selection.

Environmental sustainability is a measure of how well a material meets the needs of the present without compromising the ability of future generations to meet their own needs. The selection of environmentally sustainable materials is an integral part of what makes the completed building “green.” The design professional strives to determine which materials are produced in the most environmentally sustainable manner.

### ***What Makes Cast Iron Soil Pipe “Green”?***

Engineers, contractors, and consumers have long appreciated many of the qualities of cast iron. Cast iron soil pipe systems have earned the reputation for being quiet, reliable, noncombustible, and highly durable. Today we are pleased to add environmentally friendly to the long list of advantages of cast iron soil pipe. What makes cast iron environmentally friendly?

***Post-Consumer Recycled:*** Today, many materials manufacturers struggle to make their finished goods recyclable in an effort to label them “environmentally friendly.” The member foundries of the Cast Iron Soil Pipe Institute have taken “environmentally friendly” to a level beyond “recyclable” by utilizing 100 percent post-consumer recycled materials in the production process. Few of the materials used in construction can support this claim.

***Recyclable and Reusable*** It stands to reason that a product cast from recycled materials can itself be re-melted and recycled after its useful life has come to an end. In fact, scrap iron and steel used in the production of new cast iron soil pipe and fittings includes, in addition to parts from your old ‘72 Buick, old cast iron pipe and fittings. (See Figure 8.) In addition, engineers engaged in the renovation of old buildings often choose to reuse much of their old cast iron DWV systems. The fact that these systems can often be reused lowers the cost of renovation and decreases the number of new resources expended in the renovation—another net gain for our environment.

### ***The Green Building Council***

The Green Building Council administers a certification program for green buildings called LEED®—Leadership in Energy and Environmental Design®. LEED® is a voluntary program that the building owner can follow from the planning stages through construction to building completion, and even into the building’s useful life. There are four LEED® certification levels, depending on the number of environmental “points” achieved by the project:

Certified	26–32 points
Silver	33–38 points
Gold	39–51 points
Platinum	52–69 points



Figure 8—Scrap Metal in the Process of Being Recycled.

Points are awarded in six different point categories, one of which is Materials and Resources. The Materials and Resources category can be awarded a total of 13 points. Some of the aspects that can apply to materials include:

- Using five- to ten percent salvaged or reused materials.
- Using five- to ten percent total value of materials from reused materials and products.
  - The two factors above are most applicable to building renovations, where cast iron soil pipe is frequently reused.
- Using five- to ten percent of total value of materials from post-consumer recycled content.
  - Cast iron soil pipe can make a significant contribution to attaining this goal.
- Using 20- to 50 percent building materials that are manufactured within 500 miles.
  - Because our member foundries are within 500 miles of many large urban centers, cast iron can help the owner realize this objective.

### *Specifying The Green Pipe*

Not every foundry that produces cast iron soil pipe and fittings utilizes post-consumer recycled raw materials, and not every foundry has achieved listing in the *GreenSpec Directory*.

However, all of the Cast Iron Soil Pipe Institute member foundries use post-consumer recycled scrap iron and steel, and have achieved listing in the *GreenSpec Directory*. In addition, all of the Cast Iron Soil Pipe Institute member foundries mark their material with the familiar CISPI collective trademark. Design professionals can ensure that the pipe and fittings on their projects are environmentally friendly simply by specifying the following language:

All pipe and fittings for use in storm and sanitary drainage systems shall be cast iron and shall bear the collective trademark of the Cast Iron Soil Pipe Institute.

## CAST IRON IN FIRE RESISTIVE CONSTRUCTION

Cast iron piping systems have many advantages over alternative materials in fire-resistive construction. Cast iron piping is noncombustible and will not burn in the event of a building fire. This lack of combustibility offers two distinct advantages over alternative materials, which will burn in a building fire. Some materials have even been found to generate toxic gasses, which can be extremely hazardous to building occupants and firefighters who inhale them.

### *Prevention of Fire Spread*

Building and fire codes require that modern buildings be designed to protect building occupants and to provide them with an opportunity to escape should a fire break out. Building occupants are protected by fire-rated barriers that separate spaces within the building and are intended to contain a fire to the room or area of origination for a specific amount of time. In order for compartmentalization to be successful, every penetration of the fire-rated barrier must be sealed in order to prevent fire and smoke from traveling from one area to another. Penetrations to permit building occupants to pass into and out of the space are protected by fire-rated doors equipped with automatic closing devices to ensure they are closed should a fire break out. Other penetrations of these barriers are made to enable the passage of mechanical systems above the ceiling and below the floor. Systems must be in place to prevent smoke and flame from passing through the fire-rated barrier if a fire should break out.

### *Combustible Piping Penetrations*

When combustible piping systems are exposed to a building fire, they will burn and melt away, leaving a hole in the fire-rated barrier, thereby defeating the purpose of the barrier. Once the pipe burns away, flame and smoke can easily travel from one area to another, exposing others within the building to danger and facilitating the spread of fire and hazardous combustion gasses. Building codes have addressed this problem by requiring that penetrations of fire-rated barriers be sealed in a manner that returns the barrier to its original fire rating. Penetrations by combustible piping systems must be firestopped utilizing an approved through-penetration firestop system installed and tested in accordance with ASTM E 814 or UL 1479. These two standards provide testing procedures used to evaluate the complete assembly to ensure that the fire rating of the fire-rated barrier has been maintained after that assembly has been exposed to heat, flame, and a hose stream, as detailed in the standard.

Most firestop systems utilized for penetrations of fire-rated barriers by non-metallic pipe are similar to the one detailed in Figure 9. This system utilizes an intumescent wrap strip and a metallic restraining collar. The intumescent material expands when exposed to heat, and the restraining collar directs this intumescent reaction inward, crushing the pipe and sealing the hole in the fire-rated wall with the charred remains of the intumescent material. This system, and all firestop systems, comes with detailed installation instructions that must be strictly adhered to in order for the system to be the same system that was tested and approved, Referring to Figure 9,

1. Item 1A indicates that this is a stud wall. This particular system shows two sheets of drywall (1B) on each side of the wall.
2. Item 2 is the pipe penetrating the firewall. The assembly instructions indicate that this system is for a 4-inch diameter non-metallic pipe centered in the opening and rigidly supported on both sides of the wall assembly.
3. Items 3 A, 3B and 3C depict the firestop system. This assembly requires that the installer wrap

foil tape around the pipe prior to installation of the wrap strip. The wrap strip is a one inch wide, one inch thick intumescent elastomeric material faced on one side with aluminum foil. The wrap strip is tightly wrapped around the pipe with the foil side exposed and butted against the wall surfaces on both sides of the assembly. Four-inch diameter pipe requires four layers of wrap strip.

4. The next item to be installed (3 C) is the steel restraining collar. The steel restraining collar is sold by the firestop manufacturers and must be one inch deep with one-inch wide by two inch long anchor tabs. The restraining collar is wrapped tightly around the wrap strip and compressed using a minimum 1 inch wide by 0.028 inch thick stainless-steel band clamp at the collar mid-height.
5. Once the restraining collar has been secured to the pipe, it must be secured to the wall using four  $\frac{3}{16}$ -inch diameter steel toggle bolts. The installer must then apply a generous bead of caulk or putty around the perimeter of the wrap strip at the interface with the wall and to the perimeter of the pipe where it exits the wrap strip layers.

It is easy to read the steps above and think to oneself that there must be an easier way. One must remember, however, that the manufacturer assembled the system in exactly this manner for testing in accordance with the testing standards. Any alteration or material substitution changes the system, resulting in an untested and unapproved system. Does that mean that if drywall screws are used rather than toggle bolts to secure the collar to the firewall this no longer is an approved firestop system? That is exactly what it means. Does this mean that if a contractor uses plastic ties to restrain the collar rather than the specified stainless steel band clamp, the system will not function properly in case of a fire? Maybe... Are we suggesting that these complicated systems are not always installed in exactly the same way they were assembled for testing? Yes, unfortunately we are.

### *Noncombustible Piping Penetrations*

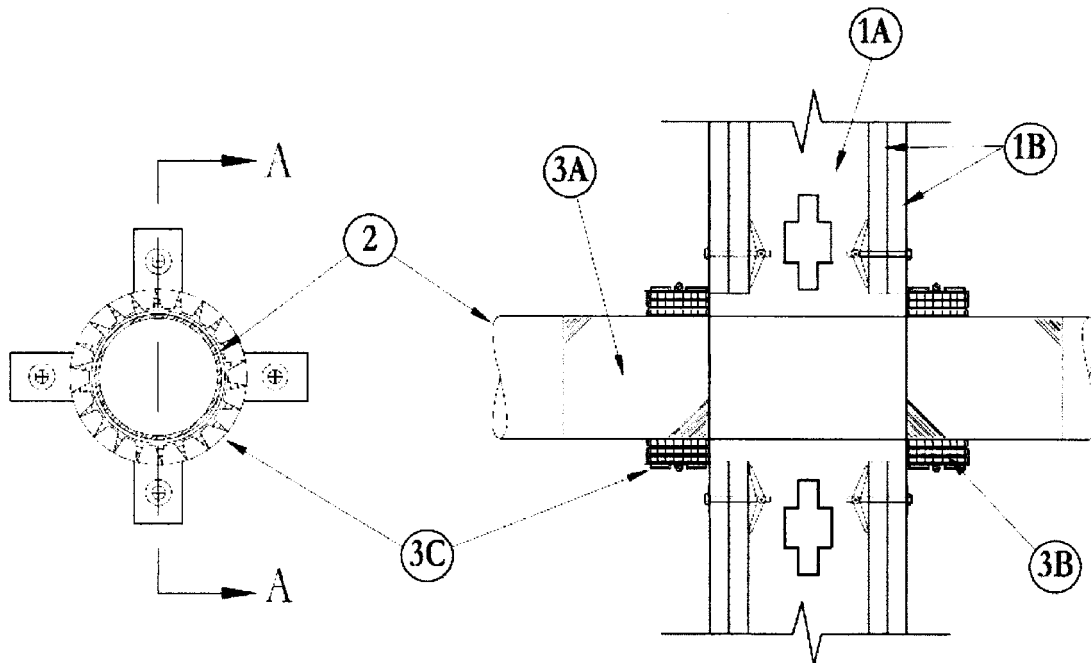

Figure 9—3M System No. W-L-2073, Through-Penetration Firestop System for Non-Metallic Piping.

<sup>1</sup> <http://multimedia.mmm.com/mws/mediawebsserver.dyn?LLLLLLuS1X&Leo4Lyo4LLETVw2R4IkX->

Fortunately, there is an alternative to these complex firestopping procedures used for combustible piping systems: Non-combustible cast iron soil pipe. Non-combustible pipe systems (including cast iron, copper, and steel) will not burn in a building fire. Because these piping systems do not burn away, leaving a hole in the fire-rated barrier, the installer is only required to seal the annular space between the wall and the pipe to firestop penetrations. In the International Building Code, for example, non-combustible penetrations up to six inches in diameter are permitted to be filled with a material sufficient to prevent the “passage of flames or hot gasses sufficient to ignite cotton waste where subject to ASTM E 119...” Although there are endothermic caulks made for this purpose, the most commonly used materials are grout, concrete, and mortar.

### ***Piping Exposed in Plenums***

The use of return-air plenums is more and more common in commercial construction today. Return-air plenums are used to return air to the HVAC system utilizing the space between the ceiling of one level and the floor of the level above. Return-air plenums are very efficient because they do not require the installation of ductwork to convey the return air from the return vent to the air-handling unit. Because of the gasses given off when combustible piping and other mechanical systems burn, these materials are prohibited from use in return-air plenums. The logic behind the prohibition is that material burning in a return-air plenum is likely to affect occupants throughout the building as the combustion byproducts are circulated throughout the building via the HVAC system. Most codes require that combustible materials approved for use in plenums be tested in accordance with ASTM E 84 and achieve a flame-spread index of not more than 25 and a smoke development index of not more than 50. Very few combustible piping materials can pass the ASTM E 84 to be approved for use in plenums. Cast iron soil pipe, because it will not burn in the event of a building fire, is approved by all national codes for use in plenums.

### **WHY SPECIFY CAST IRON SOIL PIPE IN YOUR PROJECT?**

1. Cast iron soil pipe systems provide the quietness building occupants prefer.
2. All member foundries of the Cast Iron Soil Pipe Institute utilize 100 percent post-consumer recycled iron and steel in the production of pipe and fittings. Thus, cast iron soil pipe is more environmentally friendly than many alternative piping materials.
3. Firestopping cast iron soil pipe is inexpensively and easily accomplished.
4. Noncombustible cast iron soil pipe is approved for use in return-air plenums, unlike many combustible piping materials.

A recommended firestopping specification for both combustible and non-combustible pipe penetrations can be found in Chapter XII.

# CHAPTER XI

## CAST IRON SOIL PIPE FOR CONDENSATE DRAIN LINES

Condensation and recovery (for disposal) of treated water is common to high-pressure steam systems in many industrial plants. Return of reusable water to the power house—or its drainage to a ditch, pond, or sewer—is handled through gravity systems that must be able to withstand condensate temperatures from 60°F up to 190°F. The piping used in these systems is traditionally made from stainless steel, carbon steel, or a metal alloy, because the aggressive condensate rapidly corrodes ordinary mild steel pipe.

At several manufacturing plants owned and operated by the Du Pont company, both exposed and underground gravity condensate drain lines were traditionally made of stainless steel piping. In an effort to save the high materials cost of this coated and wrapped alloy piping, a major evaluation of alternate materials was conducted at Du Pont's Engineering Test Center near Wilmington, Delaware. The evaluation program extended over a 14-month period and involved tests of three different types of fiber-reinforced plastic piping (joints made with adhesives) and cast iron soil pipe joined with neoprene compression gaskets. Results showed that the cast iron pipe gave satisfactory performance for the full test period, equivalent to the best of the plastic pipes. In addition, because of lower material costs and ease of installation, the cast iron soil pipe proved far more economical than any of the plastic systems. Details of the evaluation program are reviewed in this chapter.

### ASSEMBLY AND INSTALLATION OF MATERIALS TESTED FOR USE IN CONDENSATE DRAIN LINES

The materials tested for use in condensate drain lines are shown in Figure 1. The cast iron soil pipe system tested was joined with neoprene compression gaskets, developed mainly for use with indus-

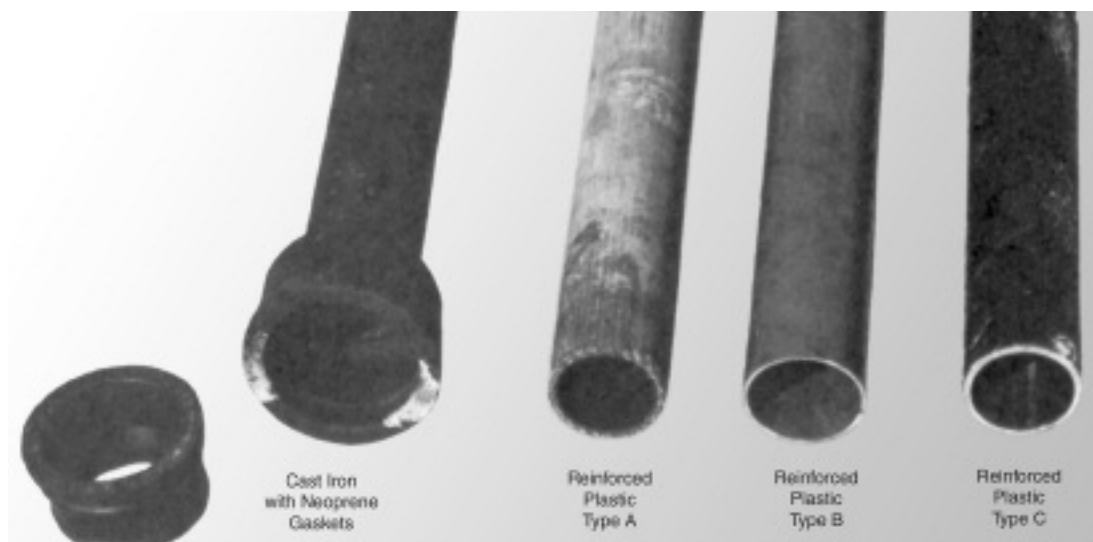

Figure 1—Materials Tested for Use in Condensate Drain Lines.

trial and residential drain, waste, and vent piping. Prior to the introduction of neoprene joint seals, cast iron soil pipe, despite its corrosion resistance, had not been used in steam condensate drain lines because the lead and oakum joints traditionally used would not remain leak-free under the extensive thermal fluctuations encountered. The three commercial brands of fiber-reinforced plastic pipe tested were all in the same materials-cost range, and all employed an adhesive system for making joints. Major differences among the three were in outside surface finish and wall thickness.

### *Assembly Procedures and Comparative Costs*

The amount of joint preparation for the plastic pipes varied with the type involved. The rough O.D. of one had to be removed using a drum sander, equipped with a dust collector for safety, thus increasing its preparation time. All three plastic pipes required strict cleanliness to obtain a satisfactory joint. As a minimum, surfaces had to be sanded, solvent wiped, and kept dry. In cold weather, the plastic pipe joint and adhesive had to be heated above 60°F before assembly. Joint cure time was also dependent upon temperature. Above 80°F, the adhesive had to be kept cool or mixed in very small quantities to prolong pot life. Without these precautions, in warm weather, adhesive pot life would have been as short as five minutes. Saddles were used to connect the water, steam, and condensate lines to the plastic pipes. This was quickly done, except in the case of the type with the rough O.D., which required more than twice as long to connect as the other two.

Some joints in the cast iron system were assembled dry; others were made using the recommended combination lubricant/adhesive. No problems were encountered during installation, and joints were made quickly and without difficulty. Previous experience with this system had proven that installation was practical at any temperature or in any weather condition in which a person would be willing to work.

Upon completion of the test assembly, it was apparent that a significantly lower cost had been incurred with the neoprene-gasketed cast iron soil pipe than with any of the fiber-reinforced plastic pipes. (See Figure 2.) This was primarily a result of the negligible joint preparation that was needed to assemble the cast iron system compared to the strict cleanliness and assembly temperature requirements for the plastic pipe.

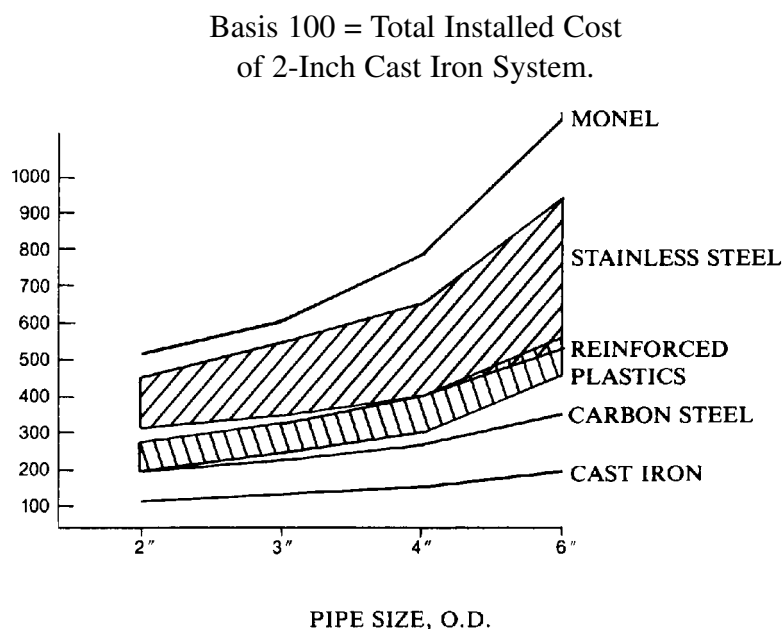

Figure 2—Comparative Costs of Steam Condensate Test Systems.



## DESCRIPTION OF TEST RIGS AND CHRONOLOGY OF TESTING PROCEDURES

### *Test Rigs*

One system of each test material was assembled from two-inch diameter pipe, with a joint located approximately every three feet along the line. Each rig consisted of a nine-foot high stack and a 30-foot long horizontal run, with a 90° turn approximately midway in the run. (See Figure 3.) The lower end of each system was left open. A ball valve was mounted at the top of each stack to provide a slight pressurization on the system. (In actual service, the upper end of a gravity drainage system's vent stack would be open to the atmosphere.)

Separate water, steam, and condensate inlets were provided near the top of each stack. Initially, cold tap water was supplied for occasional manual thermal cycling. (This was changed partway through the test to warm water, and the system was equipped for automatic thermal cycling.)

Steam was supplied from a 25 psi regulator. An impulse-type trap was used for condensate supply, with additional water injected upstream to increase the flow to approximately 2 gpm per section. Two thermocouples were installed in each line to measure pipe wall temperature. One was located in the first two feet of the horizontal run, with the second approximately 12 feet downstream of the first.

### *Testing Procedures*

The test rigs were put into service, and after two months of operation, all test lines were insulated with one-inch thick fiberglass with an asphalt-impregnated asbestos overwrap to maintain satisfactory pipe temperature during the winter weather and to simulate underground burial.

During the first five months of the test, heat in the lines was supplied by the condensate water injection system. Pipe wall temperatures averaged 145°F before insulation, and 165°F after. For the next two months, only the steam condensate was used. Pipe temperature dropped to 120°F during that time. Then the cold water supply line to the stack was replaced with a warm water discharge from another test. This pumped 110°F to 120°F water into each stack for two minutes of every eight. At that time, the introduc-

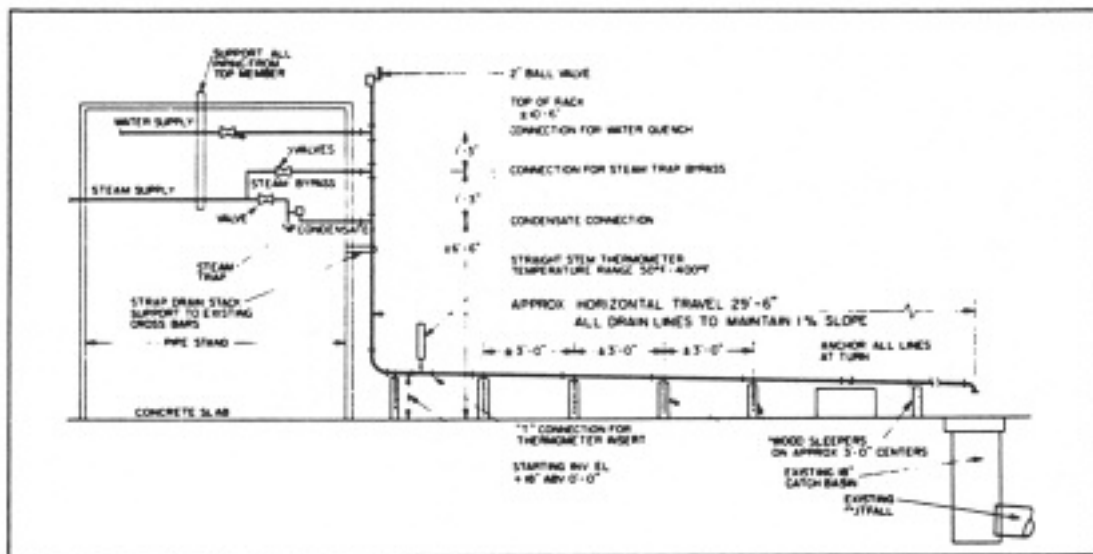

Figure 3—Details of Steam Condensate Test Systems.

tion of continuous low-pressure steam to each stack was also begun. Maximum pipe temperatures were then approximately 185°F. These decreased to approximately 145°F (in the plastic) and 160°F (in the cast iron) during the water flush cycle. The cycling rate was approximately one cycle per hour.

After nine months the systems were modified to cycle from cold water (60°F) to atmospheric steam (212°F) in alternative ten-minute intervals. Pipe temperatures recorded by the thermocouples ranged between 90°F and 200°F in the cast iron pipe to 85°F and 185°F in the plastic pipe. Three thousand cold-hot cycles were run under these conditions.

The system was again modified a month later to a cold water (65°F), 5 psig steam (225°F), ten minutes “on,” ten minutes “off” cycle. Recorded temperatures ranged between 90°F and 190°F in the cast iron, and 85°F and 175°F in the plastic pipe. A split in an elbow of one of the plastic pipes was detected during the first pressure cycle. After 300 cycles at this condition, the same material had an adhesive failure at an elbow joint. The pipe run was removed from the testing cycle. Cycling was then continued on the remaining systems to a total of 1500 cycles. (See Figure 4.)

## CONCLUSIONS AND RECOMMENDATIONS

The cast iron and two types of plastic pipe passed all tests. One type of plastic pipe failed in an adhesive joint. The elbow fitting might have cracked during the heat cycling or pressure cycling. Though considerably lower in materials cost, the cast iron pipe using the neoprene gasket performed as well as the plastics in all tests that were considered realistic in a condensate gravity drain line. It was also the easiest and least costly to assemble.

In summary, the neoprene gasketed cast iron soil pipe and two of the plastic candidates passed all test requirements. All three materials were substantially less expensive than metal alloy piping, but both materials and installation costs were far greater for the plastics than for the cast iron. This was because proper assembly of the plastics require special, labor-consuming preparation of joints. Unfavorable weather and low temperature conditions intensified difficulties of making the adhesive-bonded plastic piping joint.

Upon completion of the tests and full evaluation of the results, Du Pont’s Engineering Department issued the following recommendation to its operating plant personnel: “Recommendation that cast iron soil pipe (ASTM A74, XH or SV) with neoprene compression-type gaskets (ASTM C564) be considered as a material of construction for underground, gravity flow, non-pressure condensate drainage systems. The only design qualifications shall be that the system be properly vented to free atmosphere.”

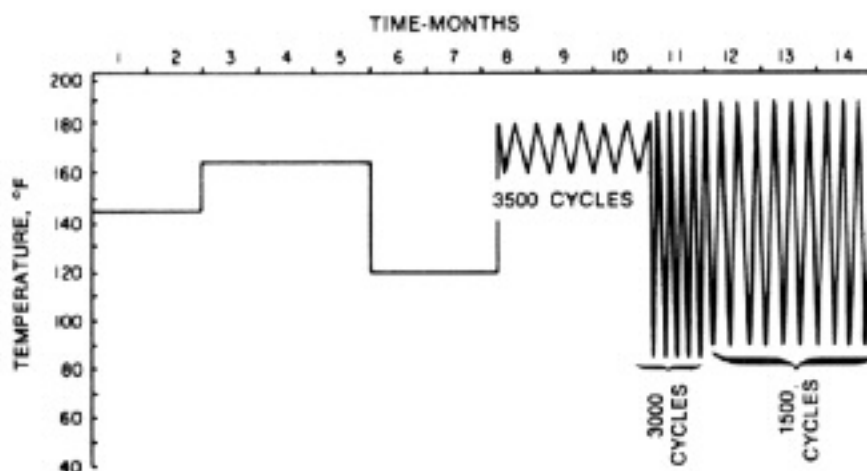

Figure 4—Pipe Wall Temperatures During Test Period.

# **CHAPTER XII**

## **SUGGESTED SPECIFICATIONS FOR ENGINEERS, ARCHITECTS, AND PLUMBING DESIGNERS FOR SANITARY DRAIN WASTE, VENT, SEWER, AND STORM DRAINAGE SYSTEMS**

### **ABOVE GRADE**

All drain, waste, vent, sewer, and storm lines shall be of cast iron soil pipe and fittings and shall conform to the requirements of CISPI Standard 301\*, ASTM A 888\*, or ASTM A 74\*. Pipe and fittings shall be marked with a collective trademark of the Cast Iron Soil Pipe Institute or receive prior approval of the engineer.

### **BELOW GRADE**

All drain, waste, vent, sewer, and storm lines shall be of cast iron soil pipe and fittings, and shall conform to the requirements of CISPI Standard 301\*, ASTM A 888\*, or ASTM A 74\*. Pipe and fittings shall be marked with a collective trademark of the Cast Iron Soil Pipe Institute or receive prior approval of the engineer.

Building or house sewers shall be of cast iron soil pipe and fittings from the building drain to point of connection with city sewer or private disposal plant. All pipe and fittings shall conform to the requirements of CISPI Standard 301\*, ASTM A 888\*, or ASTM A 74\*. Pipe and fittings shall be marked with a collective trademark of the Cast Iron Soil Pipe Institute or receive prior approval of the engineer.

### **JOINTS**

Joints for hubless pipe and fittings shall conform to the manufacturer's installation instructions, the CISPI Standard 310\* and local code requirements. Hubless coupling gaskets shall conform to ASTM Standard C-564\*.

Joints for hub-and-spigot pipe shall be installed with compression gaskets conforming to the requirements of ASTM Standard C 564\* and ASTM Standard C 1563\* or shall be installed with lead and oakum.

**Note:** Referenced standards on following page.

\*Latest issue of each standard shall apply.

**CAST IRON SOIL PIPE INSTITUTE (CISPI) STANDARD SPECIFICATIONS**

- CISPI 301: Hubless Cast Iron Soil Pipe and Fittings for Sanitary and Storm Drain, Waste, and Vent Piping Applications.
- CISPI 310: Couplings for Use in Connection With Hubless Cast Iron Soil Pipe and Fittings for Sanitary and Storm Drain, Waste, and Vent Piping Applications.

**ASTM STANDARD SPECIFICATIONS**

- A 888: Standard Specifications for Hubless Cast Iron Soil Pipe and Fittings.
- A 74: Standard Specifications for Hub and Spigot Cast Iron Soil Pipe and Fittings.
- C 564: Standard Specifications for Rubber Gaskets for Cast Iron Soil Pipe and Fittings.
- C 1563: Standard Test Method for Gaskets for Use in Connection With Hub and Spigot Cast Iron Soil Pipe and Fittings for Sanitary Drain, Waste, Vent, and Storm Piping Applications.

## FIRESTOPPING SPECIFICATION

**1) Applicability.** All piping penetrations of required fire-resistance-rated walls, partitions, floors, floor-ceiling assemblies, roof-ceiling assemblies, or shaft enclosures shall be protected in accordance with the requirements of this specification and the Building Code adopted by the Authority Having Jurisdiction. Where this specification conflicts with other specified requirements, the more restrictive requirement shall govern.

**2) Submittals.** Submittals shall indicate, with sufficient detail, how penetrations of fire-resistance-rated assemblies shall be firestopped. Submittals to include:

- a) Manufacturers Product Data Sheets for each type of product selected.
- b) System design listings, including illustrations from a qualified testing and inspection agency that is applicable to each firestop configuration.
- c) Installer qualifications to perform firestop installations.

**3) Installation.** Firestop materials shall be installed in accordance with this specification, the Building Code, and the firestop manufacturer's installation instructions. Where this specification conflicts with other specified requirements, the more restrictive requirement shall govern. Firestopping installation shall be performed by a certified installer.

### 4) Standards.

- a) ASTM Standards:
  1. E 119 Test Method for Fire Tests of Building Construction and Materials.
  2. E 814 Standard Test Method for Fire Tests of Through-Penetration Fire Stops.
  3. E 2174 Standard Practice for On-Site Inspection of Installed Fire Stops.
- b) Underwriter's Laboratories Standards:
  1. UL 1479 Fire Tests of Through-Penetration Fire Stops
- c) International Firestop Council:
  1. Ref. 1, *Recommended IFC Guidelines for Evaluating Firestop Engineering Judgments*
  2. Ref. 2, *Inspectors Field Pocket Guide*

### 5) Definitions.

- a) Penetration Firestop System: A specific assemblage of field-assembled materials, or a factory-made device, that has been tested to a standard test method and, when installed properly on penetrating piping material, has proven capable of maintaining the fire resistance rating of the fire-rated barrier penetrated.
- b) F Rating. The time period that the penetration firestop system, including the penetrating item, limits the spread of fire through the penetration when tested in accordance with ASTM E 814.
- c) T Rating. The time period that the penetration firestop system, including the penetrating item, limits the maximum temperature through the penetration on the non-fire side, when tested in accordance with ASTM E 814.

## 6) Combustible Installations.

- a) Combustible piping installations shall be protected in accordance with the appropriate fire resistance rating requirements in the building code that list the acceptable area, height, and type of construction for use in specific occupancies to assure compliance and integrity of the fire resistance rating prescribed.
- b) When penetrating a fire-resistance-rated wall, partition, floor, floor–ceiling assembly, roof–ceiling assembly, or shaft enclosure, the fire-resistance rating of the assembly shall be restored to its original rating with a material or product tested to standard ASTM E 814 or UL 1479 and at an independent testing agency acceptable to the engineer and the authority having jurisdiction.
- c) Penetrations shall be protected by an approved penetration firestop system installed as tested in accordance with ASTM E 119 or ASTM E 814, with a minimum positive pressure differential of 0.01 inch of water. Systems shall have an F rating of at least one hour but not less than the required fire-resistance rating of the assembly being penetrated. Systems protecting floor penetrations shall have a T rating of at least one hour but not less than the required fire-resistance rating of the floor being penetrated. Floor penetrations contained within the cavity of a wall at the location of the floor penetration do not require a T rating. No T rating shall be required for floor penetrations by piping that is not in direct contact with combustible material.
- d) When piping penetrates a rated assembly, combustible piping shall not connect to non-combustible piping unless it can be demonstrated that the transition complies with the requirements of item 6c.
- e) Insulation and coverings on or in the penetrating item shall not be permitted unless the specific insulating or covering material has been tested as part of the penetrating firestop system.
- f) Where sleeves are used, the sleeves should be securely fastened to the fire-resistance-rated assembly. The (inside) annular space between the sleeve and the penetrating item and the (outside) annular space between the sleeve and the fire-resistance-rated assembly shall be firestopped in accordance with the requirements for a sleeve penetrating item.

## 7) Noncombustible Piping Installations.

- a) Noncombustible piping installations shall be protected in accordance with the appropriate fire resistance rating requirements in the building code that list the acceptable area, height, and type of construction for use in specific occupancies to assure compliance and integrity of the fire-resistance rating prescribed.
- b) When penetrating a fire-resistance-rated wall, partition, floor, floor–ceiling assembly, roof–ceiling assembly, or shaft enclosure, the fire-resistance rating of the assembly shall be restored to its original rating with a material or product tested to ASTM E 119 or ASTM E 814 and at an independent testing agency acceptable to the engineer and the authority having jurisdiction.
- c) Exceptions:
  1. Concrete, mortar, or grout may be used to fill the annular spaces around cast iron, copper, or steel piping that penetrates concrete or masonry fire-resistant-rated assemblies. The nominal diameter of the penetrating item should not exceed six inches, and

the opening size should not exceed 144 in<sup>2</sup>. The thickness of concrete, mortar, or grout should be the full thickness of the assembly or the thickness necessary to provide a fire-resistance rating of the assembly penetrated; or

2. The material used to fill the annular space shall prevent the passage of flame and hot gases sufficient to ignite cotton waste for the time period equivalent to the fire-resistance rating of the assembly when tested to ASTM E 119 or ASTM E 814.
- d) Penetrations shall be protected by an approved penetration firestop system installed as tested in accordance with ASTM E 119 or ASTM E 814, with a minimum positive pressure differential of 0.01 inch of water. Systems shall have an F rating of at least one hour but not less than the required fire-resistance rating of the assembly being penetrated. Systems protecting floor penetrations shall have a T rating of at least one hour but not less than the required fire-resistance rating of the floor being penetrated. Floor penetrations contained within the cavity of a wall at the location of the floor penetration do not require a T rating. No T rating shall be required for floor penetrations by piping that is not in direct contact with combustible material.
  - e) When piping penetrates a rated assembly, combustible piping shall not connect to non-combustible piping unless it can be demonstrated that the transition complies with item 7d.
  - f) Unshielded couplings shall not be used to connect non-combustible piping unless it can be demonstrated that the fire-resistive integrity of the penetration is maintained.
  - g) Where sleeves are used, the sleeves should be securely fastened to the fire-resistance-rated assembly. The (inside) annular space between the sleeve and the penetrating item and the (outside) annular space between the sleeve and the fire-resistance-rated assembly shall be firestopped in accordance with the requirements for a sleeve-penetrating item.
  - h) Insulation and coverings on or in the penetrating item shall not be permitted unless the specific insulating or covering material has been tested as part of the penetrating firestop system.

### **8) Required Inspection.**

- a) Prior to being concealed, piping penetrations shall be inspected by the Authority Having Jurisdiction to verify compliance with the fire-resistance rating prescribed in the Building Code.
- b) Inspection shall include a thorough examination of sufficient representative installations, including destructive inspection, to provide verification of satisfactory compliance of this specification, the appropriate manufacturers' installation standards applied by the installer, construction documents, specifications, and applicable manufacturers' product information.
- c) The authority having jurisdiction shall determine the type, size, and quantity of penetrations to be inspected.
- d) The authority having jurisdiction shall compare the field installations with the documentation supplied by the installer to determine the following:
  1. The required F ratings (1,2,3, or 4 hour) and T ratings (0,1,2,3, or 4 hour) of the firestop penetration firestop systems are suitable for the assembly being penetrated.
  2. The penetrating firestop systems are appropriate for the penetrating items as documented through testing of the systems conducted by an independent testing agency.
  3. The penetrating firestop system is installed as tested.

# APPENDIX A

## STRENGTH ANALYSIS OF THIN-WALLED, SYMMETRICALLY LOADED RINGS

The correct analysis of a loaded ring can be complicated enough to justify computer solutions using finite-element methods. However, with adequate accuracy for design of the cross section (ring) of a soil-loaded cast iron soil pipe, a few reasonable assumptions result in analysis that makes design simple. Computers are not required or justified.

### SIMPLIFYING ASSUMPTIONS

1. The ring is thin walled, i.e., the ratio of wall thickness to diameter is less than ca, 1:10. If the ring is thin walled, mean diameter may be used for analysis without significant error.
2. The pipe material performs elastically.
3. Ring deformations are small. For example, stress analyses are sufficiently accurate even though the effect of ring deflection is neglected, provided that ring deflection is less than ten percent. Ring deflection is the percent decrease in vertical diameter due to soil loading. It is essentially equal to the corresponding increase in horizontal diameter. In fact, a cast iron soil pipe with  $D_m T=60$  does not deflect six percent without exceeding the modulus of rupture. Moreover, the ring is so stiff that ring deflection is generally less than one- or two percent in typical installations.
4. Loads and reactions are symmetrical around a vertical axis.
5. Loads and reactions are either concentrated loads (truck load per unit length of pipe) or uniformly distributed loads (constant pressures).
6. The three-edge bearing load is equivalent to the parallel-plate load for purposes of stress analysis. (See Figure 1.)
7. All loads and reactions are vertical. Radial pressures, such as internal pressure or external hydrostatic pressure (including internal vacuum) are disregarded. In fact, a cast iron soil pipe with  $D_m/t = 60$  can withstand over 100 psi of external hydrostatic pressure and vacuum. Clearly, internal hydrostatic pressure is of no concern in typical design. It is equivalent to a depth in water of over 230 feet.

### HORIZONTAL SOIL SUPPORT

Horizontal soil support on the sides of the ring is disregarded. This is conservative because horizontal soil support decreases ring deflection and so decreases flexural stress in the ring. (Any horizontal support provides an additional safety factor.) Horizontal soil support is not always dependable in the case of relatively stiff rings, such as in cast iron soil pipe. Because it requires either excellent



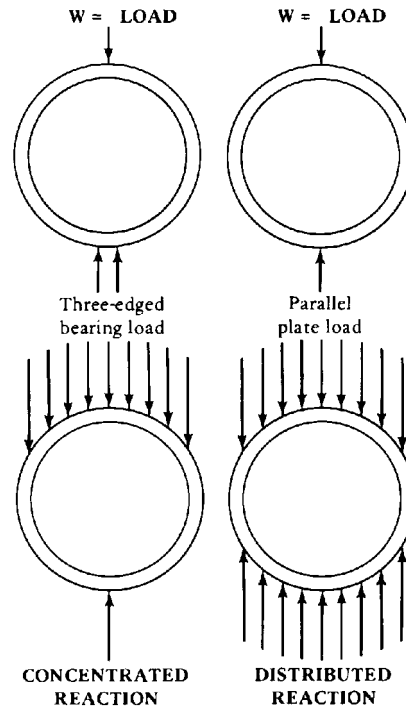

Figure 1—Typical Loads on Rings Vertical and Symmetrical.

compaction of the sidefill soil against the pipe or enough horizontal ring expansion to develop horizontal soil support. Neither can be completely assured in typical stiff-ring installations. With  $D_m/T$  less than about 60, cast iron soil pipe has a pipe stiffness greater than 250 lb/in<sup>2</sup>. Because of the ring stiffness, ring deflection of cast iron soil pipe in typical installations is less than one or two percent.

## PIPE STIFFNESS

Pipe stiffness is defined as  $F/\Delta$ , where  $F$  is a parallel plate load on a ring and  $\Delta$  is the deflection due to that load. The test procedure is essentially the same as the three-edge bearing test described in the next section. Because ring deflection is not a concern in the design of cast iron soil pipe, ring stiffness is not important and is not considered further.

## DESIGN SOIL PRESSURE

By equating  $\sigma = R$ , the failure stress is a function of the three-edge bearing load  $W$  at failure. If an appropriate safety factor is included, allowable external soil pressure  $P$  can be written in terms of  $W$ .  $P$  is the design soil pressure.

Values of  $P$  are listed in the last column of Table 1 for the three most common loadings in the design of cast iron soil pipe. The three loadings are called Installation Conditions 1, 2, and 3.

For design, the allowable  $P$  can be found from the design soil pressure equations of Table 1 in terms of three-edge bearing strength  $W$  and pipe diameter. For convenience, the values of  $P$  are found in Table 1.

## SAFETY FACTOR

A safety factor is included in each equation for  $P$ . All safety factors include 1.25 to account for statistical deviation of loads, geometry, and material properties. In addition, the idealized loads assumed for analysis are adjusted conservatively to reflect actual installation conditions.

For the concentrated reaction of Installation Condition 1, the critical stress occurs at point A. (See Table 1). The critical stress is the sum of the ring-compression stress plus the flexural stress  $M_c/I$ , where  $M_c$  is the moment that can be found by the area-moment method, virtual work, or Castigliano theorem; where  $c$ , the section modulus of the wall, is  $t^2/6$ . Noting that the ring compression stress is negligible for typical installations, the critical stress  $\sigma$  can be calculated and equated to the three-edge bearing stress  $R$  (45,000 psi) at failure (called modulus of rupture). The result is a critical load of  $PD_m = 1.084 W$ . Yet from experience, the concentrated reaction does not happen in the field. The actual distribution of the reaction justifies an increase of more than 15 or 20 percent in critical load  $PD$ . If only 15 percent, the adjusted critical load becomes  $PD = 1.25 W$  in units of pounds and feet. If the safety factor of 1.25 is included and  $D_m$  is inches, the design soil pressure is

$$P = \frac{12W}{D_m}$$

For the distribution reaction  $PD$  of Installation Condition 2, Table 1, the same reasoning applies to the safety factor except that the uniformly distributed pressure cannot be assured in the field. From experience, the actual distribution of pressure results in a slight pressure concentration that justifies a decrease of less than roughly 15 or 20 percent in the critical load  $PD$ . If 20 percent, the adjusted critical load becomes  $PD = 2.08 W$  in units of pounds and feet. If the safety factor of 1.25 is included and if  $D$  is inches, the design soil pressure is

$$P = \frac{20W}{D_m}$$

For Installation Condition 3, the same rationale for the safety factor applies as for Installation Condition 2.

It goes without saying that the margin of safety is increased significantly by such conditions as the arching action of the soil envelope, the horizontal support of the ring by sidefill soil, and the additional strength of hubs or joints. All of these conditions were conservatively neglected in the safety-factor analysis. Of course, special installation conditions may require a modified safety factor, depending on risk.

The strength of a pipe cross section (ring) is measured by the three-edge bearing test. A section of pipe barrel is positioned on two closely spaced, longitudinal quarter-round supports, as shown in Figure 2a.

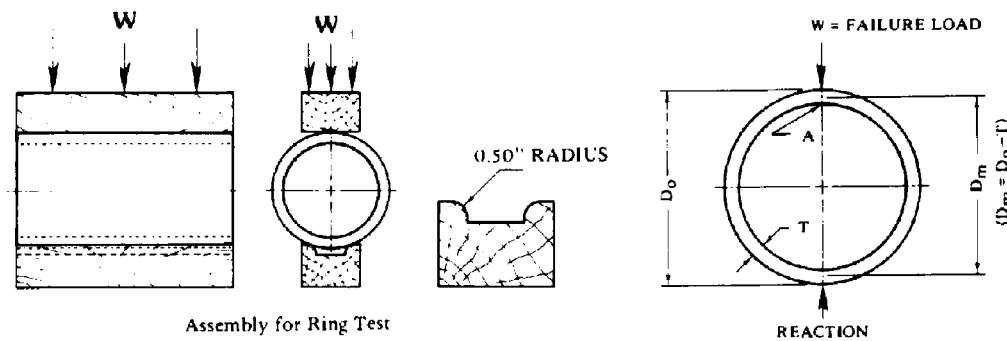

Figure 2—(a) Three-Edge Bearing Test to Determine Failure Load  $W$ ;  
(b) Equivalent Free-Body Diagram for Analysis.

**TABLE A-1**  
**Comparison of Ring Strengths for Various Ring Loadings**

Loading	Moment at A = M	$\sigma$ = Stress	Load $PD_m$ at Failure		Design Soil Pressure P Reduced by Safety Factor of 1.25
			For $\sigma = R$	**Adjusted $PD_m$	
Three-edge bearing load at failure	$M = \frac{WD_m}{2\pi}$	*R = $\frac{.0795 WD_m}{t^2}$	_____	_____	Here units are adjusted such that: W= 3-edge bearing load (lbs./lin. ft.) P= Soil Pressure (lb./lin. ft.) $D_m = (D_o - t)$ = mean diameter (in.)
Installation Condition 1	$M = \frac{PD_m^2}{4\pi} \left( \frac{2}{3} + \frac{3\pi}{8} \right)$	$\sigma = \frac{0.88}{P(D_m/t)^2}$	$PD_m = 1.084W$	$PD_m = 1.25W$	$P = \frac{12W}{D_m}$
Installation Condition 2	$M = \frac{PD_m^2}{16}$	$\sigma = 0.375P(D_m/t)^2$	$PD_m = 2.547W$	$PD_m = 2.08W$	$P = \frac{20W}{D_m}$
Installation Condition 3	$M = \frac{KPD_m^2}{16}$	$\sigma = 0.375KP(D_m/t)^2$	$PD_m = \frac{2.547W}{K}$	$PD_m = \frac{2.08W}{K}$	***P = $\frac{20W}{KD_m} = \frac{40W}{D_m}$

\*R = Stress at failure.

\*\*\*Because in practice reactions are not as ideal as assumed in diagrams, adjustment from experience is included in an adjusted load  $PD_m$ . The concentrated reaction is, in fact, slightly distributed. Consequently,  $PD_m$  is adjusted up by 15 percent. The distributed reaction is not really uniform, so  $PD_m$  is adjusted downward about 20 percent.

\*\*\*K = Stress Reduction Factor for Compressible Soil Envelope =  $\frac{1}{2}$

# **APPENDIX B**

## **TECHNIQUES FOR PLACEMENT OF SOIL AROUND BURIED CAST IRON SOIL PIPE**

The soil in which a cast iron pipe is buried should possess some basic qualities. In general, cast iron soil pipe is more forgiving of poor soil quality than is pipe of softer material. Recommended soil quality limits are as follows:

- Stones or rocks greater than three inches in diameter should not be in contact with the pipe.
- Liquid soil (mud) in which the pipe could float, sink, or shift alignment should not be used as a soil envelope unless the pipe is appropriately anchored and alignment is fixed.
- Corrosive (hot) soils should be avoided.
- Special soil engineering is required if the pipe is to be installed in expansive or collapsible soil—especially if expansion or collapse is not uniform.

### **RECOMMENDED TECHNIQUES FOR PLACEMENT OF SOIL AROUND PIPE**

#### ***Installation Condition 1***

Soil supporting the pipe must be sufficiently level so that support is provided all along the full length of the pipe. This is especially important if the gap under the pipe is great enough to allow critical deflections or critical bearing forces at the support points. (Critical deflections are either deflections at which longitudinal stress approaches the failure point, or deflections that can cause leakage at joints.)

If the base is not sufficiently flat, it should be overexcavated and backfilled to grade with select soil that can be leveled to become a suitable base.

High impact compactors should not be operated down the center line of the pipeline.

#### ***Installation Condition 2***

Soil must be placed and compacted under the haunches (below the horizontal diameter that intersects the pipe at the spring lines). The purpose is to cradle the pipe with uniform uplifting pressure under the bottom half. Loose soil, called sidefill, is placed and distributed in one lift up to the spring line on both sides of the pipe. This prevents sideshift. The sidefill may be compacted adequately by any of a number of different methods. (See Installation Condition 3.)

#### ***Installation Condition 3***

A soil arch must be densely compacted up over the pipe, springing from good abutments or rigid trench sidewalls. In so doing, the pipe and loose soil envelope in which it is packed must not be crushed or compacted. Sidefill is usually placed in lifts or layers on both sides of the loose soil envelope. These sidefill lifts can be compacted to over 90 percent density (AASHTO T-99) by any of a number of different methods. The loose soil envelope should be at least twice as high as the pipe diameter. Soil must be moved into place under the haunches. This can be done by hand use of a

bar slid down on the side of the pipe by an operator standing on the pipe. It can be done by flushing the soil into place, or vibrating the soil, or ponding, or jetting.

For Installation Condition 3, sidefill and topfill above one foot of protective cover can be compacted in lifts by any of the following techniques:

***Dumping and Shoving:*** If the soil is gravel or dry, coarse sand, it falls into place at density greater than 90 percent AASHTO T-99. It only needs to be dumped and shoved into place.

***Flushing:*** If the soil is drainable, it can be flushed into place by a high-pressure water jet directed by hand from a nozzle. Water must be removed quickly enough to prevent flotation of the pipe or loss of flushing action.

***Vibrating:*** Some soils can be compacted by vibration. If the soil is saturated, a concrete vibrator can be effective. If the soil is not saturated, commercial soil vibrators may be used.

***Mechanical Impact:*** Many types of impact compactors are now available on the market. Soil should be placed in layers, usually less than eight or ten inches, and then compacted. The soil should be at or near optimum moisture content.

## APPENDIX C

# PRESSURE REDUCTION FACTOR K FOR COMPRESSIBLE SOIL ENVELOPE

The maximum allowable vertical soil load over a buried pipe can be greatly increased by packing the pipe in a compressible soil envelope. (See Figure 1.) A well-compacted soil sidefill and topfill arches over similarly to masonry arch bridge and supports much of the load.

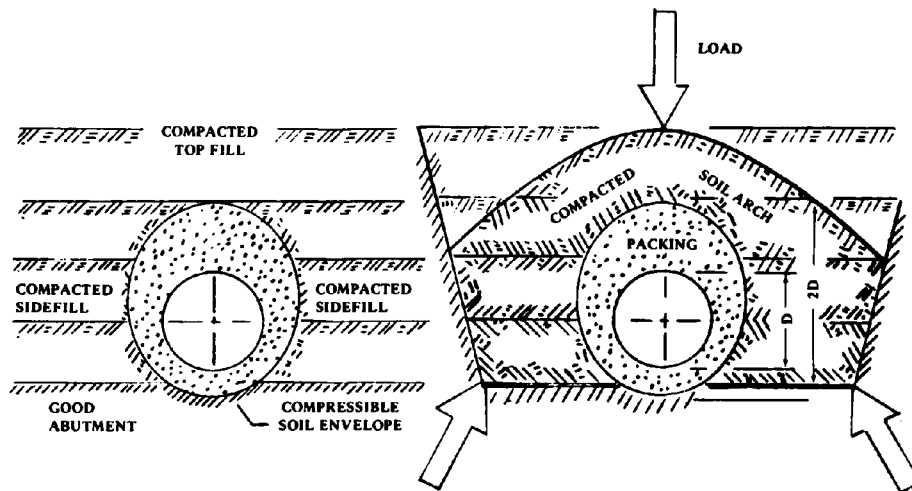

Figure 1—Pipe Packed in a Relatively Compressible Soil Envelope Showing How a  
Compacted Soil Arch Can Support the Load.

This is tantamount to the compressible packing around a fragile object in a protective crate. The crate, like a compacted soil arch, takes the brunt of the loads and shocks. Note that a well-compacted soil arch is imperative. This implies good, high-bearing abutments and densely compacted sidefill and topfill. Adequate clearance is required for compacting sidefills. The sidefill soil must be of good quality. The compressible soil envelope is usually a well-graded, sand such as the fine aggregate used in manufacture of Portland cement concrete. It is not compacted. Loose sand falls into place at a compressibility of good sidefill soil compacted to 90 percent AASHTO T-99 density or greater.

If the height of the compressible soil envelope is twice the pipe diameter, and if the pipe is assumed to be noncompressible, then the vertical strain in the envelope is twice as great as the strain in the sidefill soil. But if the vertical compressibility of the envelope is four times as great as the compressibility of the sidefill, then the vertical stress in the soil envelope is only half as great as the vertical stress in the sidefill. Clearly, the pressure reduction factor in the soil envelope would be only one fourth the vertical pressure in the soil envelope, which would be only one-fourth the vertical pressure in the sidefill for which  $K=1/4$ , and the allowable height of soil cover would quadruple. Following this line of reasoning, is there no limit? The compressibility of the soil envelope could be

increased until ultimately it is completely compressible, that is, it ceases to exist. Then  $K=0$ , the height of cover is infinite and, in fact, the pipe is entombed in a soil tunnel. Unfortunately cohesionless sidefill soil cannot retain a tunnel without a horizontal retaining side pressure inside the tunnel equal to:

$$P_x = \frac{P(1-\phi)}{(1+\sin \phi)}$$

$P_x$  =Horizontal confining pressure of soil envelope against sidefill.

$P$  =Vertical soil pressure in sidefill.

$\phi$  =Soil friction angle for sidefill.

But to maintain  $P_x$ , the minimum vertical pressure in the soil envelope  $KP$  would have to be greater than:

$$KP = P_x = \frac{(1 - \sin \phi')}{(1 + \sin \phi')}$$

or:

$$K = \frac{(1 - \sin \phi) (1 - \sin \phi')}{(1 + \sin \phi) (1 + \sin \phi')}$$

$K$  = Pressure reduction factor for compressible soil envelope.

$\phi'$  = Soil friction angle for envelope soil.

If  $\phi=\phi'=15^\circ$ , then minimum  $K=0.347$ , and the vertical pressure in the soil envelope would have to be greater than  $0.347 P$ . The compressibility would have to be less than  $2/K$  times the compressibility of the sidefills. Apparently the compressibility of the soil envelope should be less than roughly 5.8 times as compressible and more than 4 times as compressible as the sidefill if allowable depth of burial is to be doubled, i.e.,  $K = 1/2$ . Compressibility ratios must be less than 5.8, so depths of soil cover would not be tripled without great care in placing the soil envelope. With reasonable care and a pressure reduction factor of  $K = 1/2$  can be accomplished. But values less than  $1/2$  are not easily achieved under average installation procedures.

# APPENDIX D

## ABBREVIATIONS, DEFINITIONS, AND RECOMMENDED SYMBOLS FOR PLUMBING

### ABBREVIATIONS USED IN THE PLUMBING TRADES

A	Area
ABS	Acrylonitrile-butadiene-styrene
AC	Above Center
ADAPTR	Adapter
&	and
Assy	Assembly
AGA	American Gas Association
Al	Aluminum
AISI	American Iron and Steel Institute
ANSI	American National Standards Institute
API	American Petroleum Institute
ASCE	American Society of Civil Engineering
ASHRAE	American Society of Heating, Refrigeration and Air Conditioning Engineers
ASME	American Society of Mechanical Engineers
ASPE	American Society of Plumbing Engineers
ASSE	American Society of Sanitary Engineers
ASTM	American Society for Testing and Materials
Avg	Average
AWWA	American Water Works Association
BD	Bend ( $\frac{1}{8}$ , $\frac{1}{4}$ , $90^\circ$ )
B & S	Bell and Spigot (also used for Brown & Sharpe gauge)
B.O.D.	Biochemical Oxygen Demand
BTU	British Thermal Unit
C	Centigrade
C to C	Center to Center
$^\circ\text{C}$	Degree Centigrade
CF	Carlson Fitting
cfm	Cubic Feet per minute
CI	Cast Iron
$\text{C}\text{I}^\circ$	$\text{C}\text{I}^\circ$ NO-HUB <sup>®</sup> Cast Iron Soil Pipe Institute Trademark
CISP	Cast Iron Soil Pipe
CISPI	Cast Iron Soil Pipe Institute
Cl	Chlorine
CLO	Closet
CO	Cleanout
COMB	Combination



CS	Cast Steel
Cu	Copper (chemical abbreviation)
Cu. Ft.	Cubic Feet
Cu. In.	Cubic Inch
C.W.	Cold Water
DBL	Double
deg. or °	Degree
D.F.	Drinking Fountain
DH	Double Hub Cast Iron Soil Pipe
dwg	Drawing
EWC	Electric Water Cooler
EXT	Extended, Extension
F	Figure
°F	Degree Fahrenheit
Fe	Iron (Chemical Abbreviation)
FER	Ferrule
FF	Finish Floor
F.G.	Finish Grade
Fig.	Figure
FLNG	Flange
F.P.	Fire Plug
FS	Federal Specification
FTG	Fitting
F.U.	Fixture Unit
Ga or ga	Gage or Gauge
Gal.	Gallon (231 Cu. In.)
gpm or	
Ga. Per. Min.	Gallons per minute
Galv.	Galvanized
G.V.	Gate Valve
GPD	Gallons per day
H	Hydrogen (Chemical Abbreviation)
H.B.	Hose Bib
H & S	Hub and Spigot
hd. or Hd.	Head
HI	High
HOR	Horizontal
hr.	Hour
H.W.	Hot Water
I.A.P.M.O.	International Association of Plumbing and Mechanical Officials
I.C.C.	International Code Council
ID	Inside Diameter
IN	Inch
INC	Increaser, Increasing
I.P.C.	International Plumbing Code
IPS	Iron pipe size
LH	Left Hand

I or L	Length
L	Less
lav.	Lavatory
lb	Pound
LG	Long
LH	Left Hand
LNG	Long
LS	Long Sweep
/MAIN	On Main
Max	Maximum
MCAA	Mechanical Contractors Association of America
MGD	Million Gallons Per Day
Mfr.	Manufacturer
M.H.	Manhold
MI	Malleable Iron
Min.	Minimum
Min.	Minute
MN	On Main
MS	Mild Steel
NAPHCC	National Association of Plumbing, Heating and Cooling Contractors
NBFU	National Board of Fire Underwriters
NBS	National Bureau of Standards
NFPA	National Fire Protective Association
NH	Hubless Pipe & Fittings
NPS	Nominal Pipe Size (also called IPS)
NSF	NSF International
O	Oxygen (Chemical Abbreviation)
O.D.	Outside Diameter
oz.	Ounce
P.	Pressure
Pb	Lead (chemical abbreviation)
PDI	Plumbing Drainage Institute
PIV	Post Indicator Valve
pH	Hydrogen-ion concentration
PHCC NA	Plumbing Heating Cooling Contractors – National Association
ppm	Parts per Million
psi	Pounds per Square Inch
psig	Pounds per Square Inch Gage
PVC	Polyvinyl Chloride
qt	Quart
R	Hydraulic Radius
Rad	Radius
RD	Rate of Demand
R.D.	Roof Drain
red.	Reducer
REV	Revent
RH	Right Hand

R.L.	Roof Leader
RS	Rate of Supply
S	Hydraulic slope (in inches per ft.)
San	Sanitary
Sb	Antimony (chemical abbreviation)
SD	Side
Sec	Second
SH	Single Hub Cast Iron Soil Pipe
SL & Notch	Slotted & Notched
Sn	Tin (chemical abbreviation)
SO	Side Opening
Spec	Specification
Sq	Square
Sq. Ft.	Square Feet
Sq. In.	Square Inches
SS	Service Sink
SS	Short Sweep
SSU	Seconds Saybolt Universal
ST	Sanitary Tap
Std	Standard
SV	Service Cast Iron Soil Pipe
S & W	Soil & Waste
T	Tee
T or t	Temperature
T or t	Thickness
t	Time
TAP	Tap, Tapped
TOT	Tap on Top
TP	Tap, Tapped
TY	Tee Wye, (San Tee)
U or Urn	Urinal
U.L.	United Laboratories, Inc.
UPC	Uniform Plumbing Code
v	Valve
v	Velocity
v	Vent
V	Volume
VERT	Vertical
vtr	Vent through roof
W	Waste
W/	With
WC	Water Closet
WH	Wall Hydrant
W.L.	Water Level
Wt	Weight
XH	Extra Heavy Cast Iron Soil Pipe
Y	Wye

**DEFINITIONS USED IN THE PLUMBING TRADES**

**AEROBIC**—Living with air.

**ABSORPTION**—Applies to immersion in a fluid for a definite period of time. Usually expressed as a percent of the weight of the dry pipe.

**ANAEROBIC**—Living without air.

**ANCHOR**—Usually a piece of metal used to fasten or secure pipes to the building or structure.

**AREA OF CIRCLE**—The square of the radius multiplied by  $\pi$ (3.1416). Area =  $\pi^2$  or (rxrx3.1416).

**BACKFILL**—Portion of the trench excavation that is replaced after the sewer line has been laid. The material above the pipe up to the original earth line.

**BACKFLOW**—The flow of water or other liquids, mixtures, or substances into the distribution pipe of a potable supply of water from any source other than that intended.

**BACKFLOW PREVENTER**—A device or assembly designed to prevent backflow into the potable water system.

**BACK-SIPHONAGE**—A term applied to the flow of used water, wastes, and/or contamination into the potable water supply piping due to vacuums in the distribution system, building service, water main or parts thereof.

**BASE**—The lowest portion or lowest point of a stack of vertical pipe.

**BRANCH**—Any part of the piping system other than a main riser, or stack.

**CAST IRON SOIL PIPE**—The preferred material for drain, waste, vent, and sewer systems.

**CAULKING**—A method of sealing against water or gas by means of pliable substances, such as lead and oakum.

**CI No-Hub<sup>®</sup>** — A registered trademark of the Cast Iron Soil Pipe Institute.

**CIRCUMFERENCE OF CIRCLE**—The diameter of the circle multiplied by  $\pi$ . Circumference =  $\pi D$ .

**CLARIFIED SEWAGE**—A term used for sewage from which suspended matter has been removed.

**CODE**—An ordinance, rule, or regulation that a city or governing body may adopt to control the plumbing work within its jurisdiction.

**COLIFORM BACTERIA**—Organisms in the *coili aerogenes* group, as set forth in the American Water Works Association and the American Public Health Association literature.

**COMPRESSION**—Stress that resists the tendency of two forces acting toward each other.

**CONDUCTOR**—That part of the vertical piping which carries the water from the roof to the storm drain, which starts either six inches above grade if outside the building, or at the roof sump or gutter if inside the building.

**CROSS CONNECTION**—(or inter-connection) Any physical connection between a city water supply and any waste pipe, soil pipe, sewer, drain, or any private or uncertified water supply. Any potable water supply outlet that is submerged or can be submerged in wastewater and/or any other source of contamination.

**CRUDE OR RAW SEWAGE**—Untreated sewage.

**DEAD END**—A branch leading from any soil, waste, or vent pipe, building drain, or building sewer, which is terminated at a distance of two feet or more by means of a cap, plug, or other fitting not used for admitting water or air to the pipe, except branches serving as cleanout extensions.

**DEVELOPED LENGTHS**—Length measured along the center line of the pipe and fittings.

- DIAMETER**—A straight line that passes through the center of a circle and divides it in half.
- DIGESTER/DIGESTION**—Portion of the sewage treatment process when biochemical decomposition of organic matter takes place, resulting in the formation of simple organic and mineral substances.
- DOMESTIC SEWAGE**—Sewage originating principally from dwellings, business buildings, and institutions, and usually not containing storm water. In some localities it may include industrial wastes and rain water from combination sewers.
- DRAIN**—Any pipe that carries wastewater or water-borne wastes in a building drainage system.
- DRAIN, BUILDING OR HOUSE**—Part of the lowest horizontal piping of a building drainage system that receives and conveys the discharge from soil, waste, and drainage pipes, other than storm drains, from within the walls or footings of any building to the building sewer.
- DRAINS, COMBINED**—Portion of the drainage system within a building that carries storm water and sanitary sewage.
- DRAINS, STORM**—Piping and its branches that convey subsoil and/or surface water from areas, courts, roofs, or yards to the building or storm sewer.
- DRAINS, SUBSOIL**—Part of the drainage system that conveys the subsoil, ground, or seepage water from the footings of walls or from under buildings to the building drain, storm water drain, or building sewer.
- DRY-WEATHER FLOW**—Sewage collected during the dry weather that contains little or no ground water and no storm water.
- DUCTILITY**—The property of elongation above the elastic limit but short of the tensile strength.
- EFFLUENT**—Sewage, treated or partially treated, flowing from sewage treatment equipment.
- ELASTIC LIMIT**—The greatest stress a material can withstand without permanent deformation after release of stress.
- EROSION**—The gradual destruction of metal or other materials by the abrasive action of liquids, gases, solids, or mixtures of these materials.
- EXISTING WORK**—Portion of a plumbing system that has been installed prior to current or contemplated addition, alteration or correction.
- FIXTURES, BATTERY OF**—Any group of two or more similar adjacent fixtures that discharge into a common horizontal waste or soil branch.
- FIXTURES, COMBINATION**—Any integral unit, such as a kitchen sink or laundry unit.
- FIXTURES, PLUMBING**—Installed receptacles, devices, or appliances that are supplied with water, or which receive liquids and/or discharge liquids, or liquid-borne wastes, either directly or indirectly into a drainage system.
- FIXTURE UNIT**—Amount of fixture discharge equivalent to 7½ gallons or more; one cubic foot of water per minute.
- FLOOD LEVEL RIM**—The top edge of the receptacle from which water overflows.
- FLUSH VALVE**—A device located at the bottom of the tank for flushing water closets and similar fixtures.
- FLUSHMETER VALVE**—A device that discharges a predetermined quantity of water to a fixture for flushing purposes; powered by direct water pressure.
- FOOTING**—The part of a foundation wall resting on the bearing soil, rock, or piling that transmits the superimposed load to the bearing material.

- FRESH SEWAGE**—Sewage of recent origin still containing free dissolved oxygen.
- INVERT**—A line that runs lengthwise along the base of the channel at the lowest point on its wetted perimeter, its slope established when the sewer or drain is installed.
- LATERAL SEWER**—A sewer that does not receive sewage from any other common sewer except house connections.
- LEACHING WELL OR CESSPOOL**—Any pit or receptacle with porous walls that permits the contents to seep into the ground
- LEADER**—The piping from the roof that carries rainwater.
- MAIN SEWER**—The main stem or principal artery of the sewage system to which branches may be connected (also called the trunk sewer).
- MASTER PLUMBER**—A plumber licensed to install and assume responsibility for contractual agreements pertaining to plumbing and to secure any required permits. The journeyman plumber is licensed to install plumbing under the supervision of a master plumber.
- NO-HUB**—Classification of cast iron soil pipe joined using no-hub couplings. Also referred to as hubless and CI No-Hub®
- NO-HUB Couplings**—Used for joining hubless pipe and fittings.
- OFFSET**—In a line of piping, a combination of pipe, pipes, and/or fittings that join two approximately parallel sections of a line of pipe.
- OUTFALL SEWERS**—Sewers that receive sewage from the collection system and carry it to the point of final discharge or treatment; usually the largest sewer of a system.
- OXIDIZED SEWAGE**—Sewage in which the organic matter has been combined with oxygen and has become stable.
- PIPE, HORIZONTAL**—Any pipe installed in a horizontal position or that makes an angle of less than 45° from the horizontal.
- PIPE, INDIRECT WASTE**—Pipe that does not connect directly with the drainage system but conveys liquid wastes into a plumbing fixture or receptacle that is directly connected to the drainage system.
- PIPE, LOCAL VENTILATING**—A pipe on the fixture side of the trap through which pipe vapors or foul air can be removed from a room fixture.
- PIPE, SOIL**—Any pipe which conveys to the building drain or building sewer the discharge of one or more water closets and/or the discharge of any other fixture receiving fecal matter, with or without the discharge from other fixtures.
- PIPE, SPECIAL WASTE**—Drain pipe that receives one or more wastes that require treatment before entry into the normal plumbing system; the special waste pipe terminates at the treatment device on the premises.
- PIPE, VERTICAL**—Any pipe installed in a vertical position or that makes an angle of not more than 45° from the vertical.
- PIPE, WASTE**—A pipe that conveys only liquid or liquid-borne waste, free of fecal matter.
- PIPE, WATER RISER**—A water supply pipe that extends vertically one full story or more to convey water to branches or fixtures.
- PIPE, WATER DISTRIBUTION**—Pipes that convey water from the service pipe to its points of usage.

- PIPES, WATER SERVICE**—That portion of the water piping which supplies one or more structures or premises and that extends from the main to the meter or, if no meter is provided, to the first stop cock or valve inside the premises.
- PITCH**—The amount of slope given to horizontal piping, expressed in inches or vertically projected drop per foot of horizontal pipe.
- PLUMBING**—The practice, materials, and fixtures used in the installation, maintenance, extension, and alteration of all piping, fixtures, appliances, and appurtenances in connection with any of the following: Sanitary drainage or storm drainage facilities; venting system and public or private water-supply systems; also the practice and materials used in the installation, maintenance, extension, or alteration of water-supply systems and/or the storm water, liquid waste, or sewage system of any premises to their connection with any point of public disposal or other acceptable termina.
- PLUMBING INSPECTOR**—Any person who, under the supervision of the Authority Having Jurisdiction, is authorized to inspect plumbing and drainage as defined in the code for the municipality, and complying with the laws of licensing and/or registration of the State, City, or County.
- PRECIPITATION**—The total measurable supply of water received directly from clouds as snow, rain, hail, and sleet. It is usually expressed in inches per day, month, or year.
- PRIVATE USE**— A term which applies to a toilet room or bathroom intended specifically for the use of an individual or family and such visitors as they may permit to use such toilet or bathroom.
- PUBLIC USE**—A term that applies to toilet rooms and bathrooms used by employees, occupants, visitors, or patrons in or about any premises.
- PUTREFACTION**—Biological decomposition of organic matter resulting in foul-smelling products. It usually takes place where there is a deficiency of oxygen.
- REVENT (individual vent)**—Part of a vent pipe line that connects directly with any individual waste pipe or group of wastes, underneath or behind the fixture, and extends to the main or branch vent pipe.
- ROUGHING IN**—A term referring to the installation of all parts of the plumbing system that should be completed before the installation of plumbing fixtures. Includes drainage, water supply, vent piping, and necessary fixture connections.
- SANITARY SEWER**—The conduit of pipe carrying sanitary sewage, storm water, and infiltration of ground water.
- SEPTIC SEWAGE**—Sanitary sewage undergoing putrefaction.
- SEPTIC TANK**—A receptacle that receives the discharge of a drainage system or part thereof, and is designed and so constructed as to separate solids from liquids to discharge into the soil through a system of open-joint or perforated piping, or into a disposal pit.
- SEWAGE**—Any liquid waste containing animal, vegetable, or chemical wastes in suspension or solution.
- SEWER, BUILDING**—Also called house sewer. That part of the horizontal piping of a drainage system extending from the building drain, storm drain, and/or subsoil drain to its connection into the point of disposal and carrying the drainage of a building or part thereof.
- SEWER, BUILDING STORM**—The extension from the building storm drain to the point of disposal.

al (also called house storm sewer).

**SEWER, PRIVATE**—A sewer located on private property that conveys the drainage of one or more buildings to a public sewer or to a privately owned sewage disposal system.

**SEWER, STORM**—A sewer used to convey rainwater, surface water, condensate, cooling water, or similar water wastes, exclusive of sewage and industrial wastes.

**SLICK**—The thin, oily film that gives the characteristic appearance to the surface of water into which sewage or oily water is discharged.

**SLUDGE**—The accumulated suspended solids of sewage deposited in tanks, beds, or basins mixed with sufficient water to form a semiliquid mass.

**STACK**—The vertical main of a system of soil, waste, or vent piping.

**STACK VENT**—The extension of a soil or waste stack above the highest horizontal drain connected to the stack.

**STALE SEWAGE**—Sewage that contains little or no oxygen but is free from putrefaction.

**STRAIN**—Change of shape or size produced by stress.

**STRESS**—External forces resisted by reactions within.

**SUB-MAIN SEWER**—A sewer into which the sewage from two or more lateral sewers is discharged (also called branch sewer).

**SUBSOIL DRAIN**—A drain that receives the discharge from drains or other wastes located below the normal grade of the gravity system, which must be emptied by mechanical means.

**SUMP**—A tank or pit that receives the discharge from drains or other wastes, located below the normal grade of the gravity system, which must be emptied by mechanical means.

**TENSION**—That stress that resists the tendency of two forces acting opposite from each other to pull apart two adjoining planes of a body.

**TRAP**—A fitting or device so designed and constructed as to provide, when properly vented, a liquid seal that will prevent the back passage of air or sewer gas without materially affecting the flow of sewage or wastewater through it.

**TRAP SEAL**—The vertical distance between the crown weir and the top of the dip of the trap.

**TURBULENCE**—Any deviation from parallel flow.

**UNDERGROUND PIPING**—Piping in contact with the earth below grade. Pipe in a tunnel or in a watertight trench is not included within the scope of this term.

**VACUUM**—Any pressure less than that exerted by the atmosphere (also called negative pressure).

**VELOCITY**—Time rate of motion in a given direction.

**VENT, CIRCUIT**—A branch vent that serves two or more traps and extends from in front of the last fixture connection of a horizontal branch to the vent stack.

**VENT, COMMON**—Also called dual vent, vent connecting at the junction of two fixture drains and serving as a vent for both fixtures.

**VENT, CONTINUOUS**—A vent that is a continuation of the drain to which it connects. A continuous vent is further defined by the angle which the drain and vent make with the horizontal at the point of connection; for example, vertical continuous waste-and-vent, 45° continuous waste-and-vent, and flat (small angle) continuous waste-and-vent.

**VENT STACK**—A vertical vent pipe installed primarily to provide circulation of air to that part of a venting system to which circuit vents are connected. Branch vents, revents, or individual vents may be led to and connected with a vent stack. The foot of the vent stack may be con-



nected either into a horizontal drainage branch or into a soil or waste stack.

**VENT SYSTEM**—Pipes installed to provide airflow to or from a drainage system or to provide air circulation within such system to protect trap seals from siphonage and back pressure.

**VENT, WET**—A vent that receives the discharge of wastes other than from water closets.











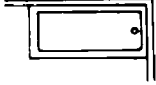

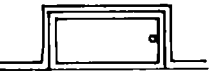
**VENTING, STACK**—A method of venting a fixture through the soil and waste stack.

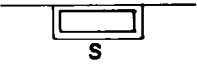
**VENTS, INDIVIDUAL**—Separate vents for each fixture.



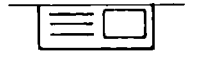
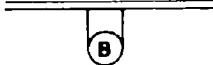
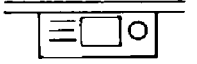
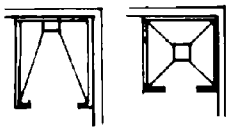
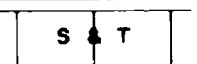
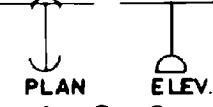
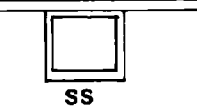
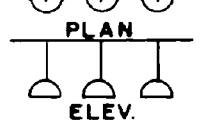
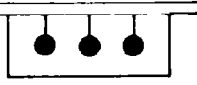

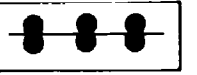
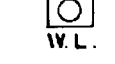







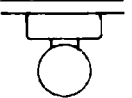











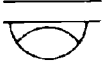

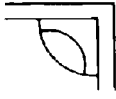

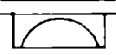
**WASTE**—The discharge from any fixture, appliance, or appurtenance in connection with the plumbing system that does not contain fecal matter. For example, the liquid from a lavatory, a tub, a sink, or a drinking fountain.

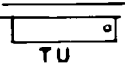
**RECOMMENDED SYMBOLS FOR PLUMBING**

*Symbols for Fixtures<sup>1</sup>*

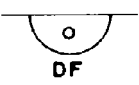
	<b>CORNER BATH</b>		<b>MANICURE LAVATORY</b>
	<b>RECESSED BATH</b>		<b>DENTAL LAVATORY</b>
	<b>ROLL RIM BATH</b>		<b>PLAIN KITCHEN SINK</b>
	<b>SITZ BATH</b>		<b>KITCHEN SINK, R &amp; L DRAIN BOARD</b>
	<b>FOOT BATH</b>		<b>KITCHEN SINK, LH DRAIN BOARD</b>
	<b>BIDET</b>		<b>COMBINATION SINK AND DISH WATER</b>
	<b>SHOWER STALL</b>		<b>COMBINATION SINK AND LAUNDRY TRAY</b>
	<b>SHOWER HEAD</b>		<b>SERVICE SINK</b>
	<b>OVERHEAD GANG SHOWER</b>		<b>WASH SINK, WALL TYPE.</b>
	<b>PEDESTAL LAVATORY</b>		<b>WASH SINK</b>
	<b>WALL LAVATORY</b>		
	<b>CORNER LAVATORY</b>		

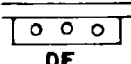









<sup>1</sup> Symbols adopted by the American National Standards Association (ANSI)













	LAUNDRY TRAY		HOT WATER TANK
	WATER CLOSET (LOW TANK)		WATER HEATER
	WATER CLOSET (LOW TANK)		METER
	WATER CLOSET (NO TANK)		HOSE RACK
	WATER CLOSET		HOSE BIBB
	WATER CLOSET		GAS OUTLET
	URINAL (PEDESTAL TYPE)		VACUUM OUTLET
	URINAL (WALL TYPE)		DRAIN
	URINAL (CORNER TYPE)		GREASE SEPARATOR
	URINAL (STALL TYPE)		OIL SEPARATOR
	URINAL (TROUGH TYPE)		CLEANOUT
	DRINKING FOUNTAIN (PEDESTAL TYPE)		GARAGE DRAIN
	DRINKING FOUNTAIN (WALL TYPE)		FLOOR DRAIN WITH BACKWATER VALVE
	DRINKING FOUNTAIN (TROUGH TYPE)		ROOF SUMP

*Symbols for Pipe Fittings and Valves*

FLANGED	SCREWED	BELL & SPIGOT	WELDED	SOLDERED	
					<b>JOINT</b>
					<b>ELBOW - 90°</b>
					<b>ELBOW - 45°</b>
					<b>ELBOW - TURNED UP</b>
					<b>ELBOW - TURNED DOWN</b>
					<b>ELBOW - LONG RADIUS</b>
					<b>SIDE OUTLET ELBOW - OUTLET DOWN</b>
					<b>SIDE OUTLET ELBOW - OUTLET UP</b>
					<b>BASE ELBOW</b>
					<b>DOUBLE BRANCH ELBOW</b>
					<b>SINGLE SWEEP TEE</b>
					<b>DOUBLE SWEEP TEE</b>
					<b>REDUCING ELBOW</b>
					<b>TEE</b>
					<b>TEE - OUTLET UP</b>
					<b>TEE - OUTLET DOWN</b>
					<b>SIDE OUTLET TEE - OUTLET UP</b>
					<b>SIDE OUTLET TEE - OUTLET DOWN</b>
					<b>CROSS</b>
					<b>REDUCER</b>
					<b>ECCENTRIC REDUCER</b>

FLANGED	SCREWED	BELL & SPIGOT	WELDED	SOLDERED	
					LATERAL
					GATE VALVE
					GLOBE VALVE
					ANGLE GLOBE VALVE
					ANGLE GATE VALVE
					CHECK VALVE
					ANGLE CHECK VALVE
					STOP COCK
					SAFETY VALVE
					QUICK OPENING VALVE
					FLOAT OPERATING VALVE
					MOTOR OPERATED GATE VALVE
					MOTOR OPERATED GLOBE VALVE
					EXPANSION JOINT FLANGE
					REDUCING FLANGE
					UNION
					SLEEVE
					BUSHING

CHARACTER	PLAN	LINE	OR
CIRC. HOT CITY WATER		-----	
CHILLED DRINK. WATER		-----	
FIRE LINE		-----	----- F -----
COLD INDUSTRIAL WATER		-----	
HOT INDUSTRIAL WATER		-----	
CIRC. HOT INDUS. WATER		-----	
AIR		-----	----- A -----
GAS		-----	----- G -----
OIL		-----	----- O -----
VACUUM CLEANER		-----	----- V -----
LOCAL OR SURFACE VENT		-----	

CHARACTER	PLAN	LINE
SANITARY SEWAGE		-----
SOIL STACK		-----
WASTE STACK		-----
VENT STACK		-----
COMBINED SEWAGE		-----
STORM SEWAGE		-----
ROOF LEADER		-----
INDIRECT WASTE		-----
INDUSTRIAL SEWAGE		-----
ACID OR CHEMICAL WASTE		-----
COLD CITY WATER		-----
HOT CITY WATER		-----

# APPENDIX E STATISTICAL TABLES AND CALCULATIONS

**TABLE 1**  
*Expansion of Pipe*

Expansion: Allowances for expansion and contraction of building materials are important design considerations. Material selection can create or prevent problems. *Cast iron is in tune with building reactions to temperature. Its expansion is so close to that of steel and masonry that there is no need for costly expansion joints and special off-sets.* That is not always the case with other DWV materials.

Thermal expansion of various materials.

Material	Inches per inch 10 <sup>6</sup> X per °F	Inches per 100' of pipe per 100°F.	Ratio-assuming cast iron equals 1.00
Cast iron	6.2	0.745	1.00
Concrete	5.5	0.66	.89
Steel (mild)	6.5	0.780	1.05
Steel (stainless)	7.8	0.940	1.26
Copper	9.2	1.11	1.49
PVC (high impact)	55.6	6.68	8.95
ABS (type 1A)	56.2	6.75	9.05
Polyethylene (type 1)	94.5	11.4	15.30
Polyethylene (type 2)	83.3	10.0	13.40

Here is the *actual* increase in length for 50 feet of pipe and 70° temperature rise.

Cast Iron		.261
Concrete		.231
Mild Steel	Building Materials	2.73
Copper	Other Materials	.388
PVC (high Impact)	Plastics	2.338
ABS (type 1A)		2.362
Polyethylene (type 1)		3.990
Polyethylene (type 2)		3.500

**TABLE 2**  
***Thrust or Displacement Forces Encountered in  
 Hydrostatic Testing of Hubless Cast Iron Soil Pipe***

Pipe Size		1½"	2"	3"	4"	5"	6"	8"	10"	12"	15"
Head, Feet of Water	Pressure psi	Thrust lb.	Thrust lb.	Thrust lb.	Thrust lb.	Thrust lb.	Thrust lb.	Thrust lb.	Thrust lb.	Thrust lb.	Thrust lb.
10	4.3	12	19	38	65	95	134	237	377	538	847
20	8.7	25	38	77	131	192	271	480	762	1088	1714
30	13.0	37	56	115	196	287	405	717	1139	1626	2562
40	17.3	49	75	152	261	382	539	954	1515	2164	3409
50	21.7	62	94	191	327	479	676	1197	1900	2714	4276
60	26.0	74	113	229	392	574	810	1434	2277	3252	5124
70	30.3	86	132	267	457	668	944	1671	2654	3790	5971
80	34.7	99	151	306	523	765	1082	1914	3039	4340	6838
90	39.0	111	169	344	588	860	1216	2151	3416	4878	7685
100	43.4	123	188	382	654	957	1353	2394	3801	5429	8552
110	47.7	135	208	420	719	1052	1487	2631	4178	5967	9400
120	52.0	147	226	458	784	1147	1621	2868	4554	6505	10247
Area, OD. in. <sup>2</sup>		2.84	4.34	8.81	15.07	22.06	31.17	55.15	87.58	125.09	197.06

Thrust = Pressure x Area



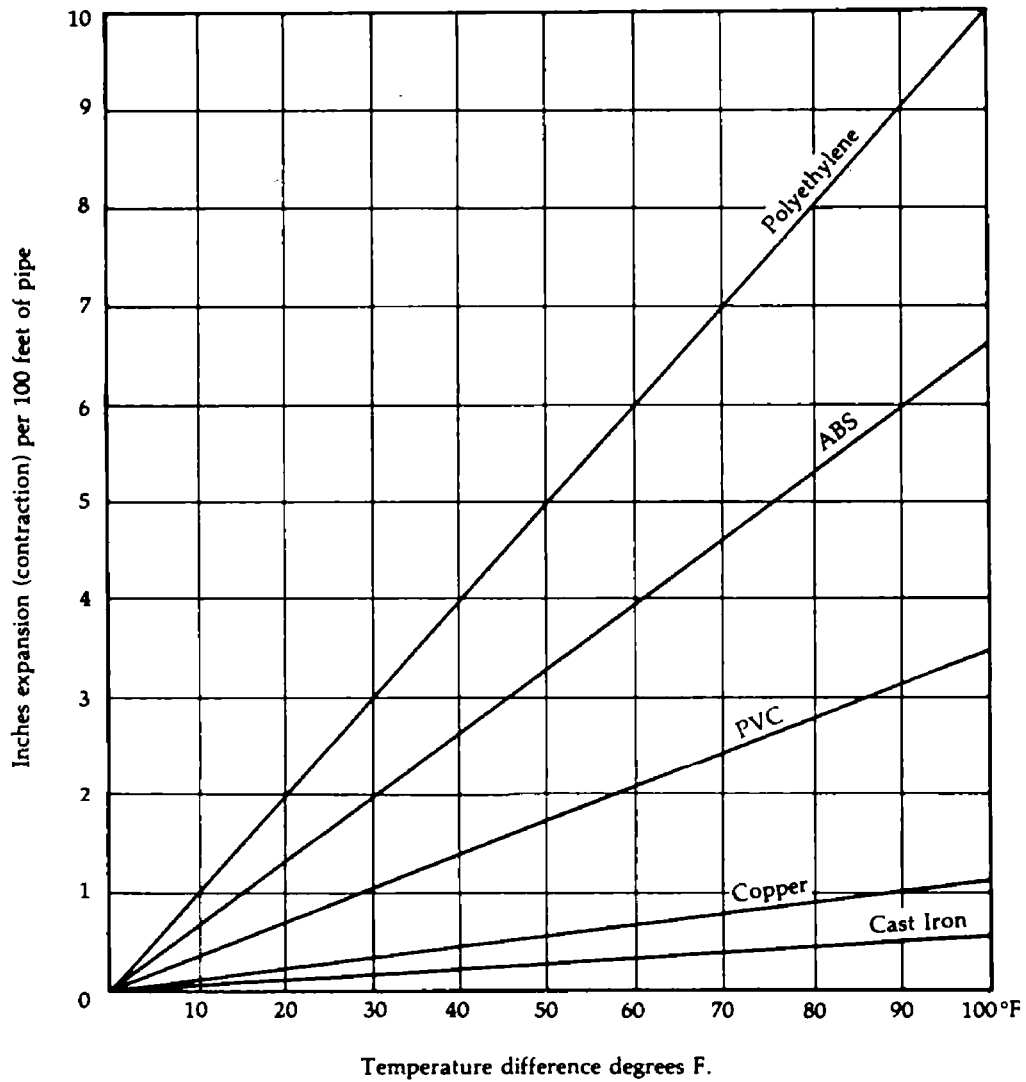

Figure 1—Expansion in Plumbing Systems.

Example: Find the expansion allowance required for a 120 ft. run of ABS pipe in a concrete & masonry building and for a temperature difference of 90°F.

Answer: At a temperature difference of 90°F read from the chart, ABS expands 6" and concrete expands  $\frac{3}{4}$ ".

$$(6 - \frac{3}{4}) \times \frac{120}{100} = 5 \frac{1}{4} \times \frac{120}{100} = 6.3 \text{ inches}$$

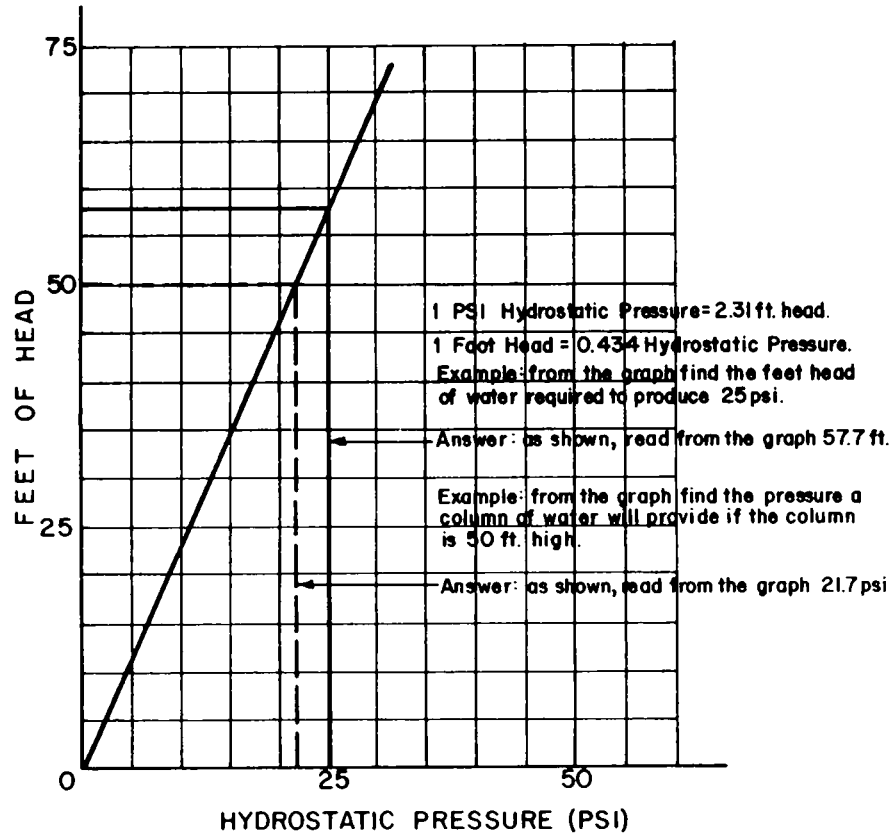

Figure 2 Hydrostatic Conversion Graph. Feet of Head Into Pounds Per Sq. In.  
(See Table 2, Page \_\_)

## CYLINDRICAL TANK CAPACITIES

(By Calculation)

Where D is the diameter in inches

r is the radius, or half the diameter in inches

r is half the diameter in inches

L is the length or height in inches

$$\text{Volume in Gallons} = \frac{\pi \times r^2 \times L}{231}$$

---

If D, r and L are measured in feet.

$$\text{Volume in Gallons} = \pi \times r^2 \times L \times 7.48$$

Note: 1 gallon contains 231 cu. inches

1 cu. ft. contains 7.48 gallons

*SAMPLE PROBLEM*

Let D equal 24"

r equal 12"

L equal 48"

$$\begin{aligned} \text{Volume} &= \frac{\pi r^2 \times 48}{231} \\ &= \frac{3.1416 \times 12 \times 12 \times 48}{231} \\ &= 93.006 \text{ gallons, or } 94.0 \text{ Ans.} \end{aligned}$$

---

*SAMPLE PROBLEM*

Let D equal 2 ft.

r equal 1 ft.

L equal 4 ft.

Find volume in gallons

$$\begin{aligned} \text{Volume} &= \pi \times r^2 \times 4 \times 7.48 \\ &= 93.006 \text{ gallons, or } 94.0 \text{ Ans.} \end{aligned}$$

---

*The formula for the volume is:*

$$\text{U.S. Gallons} = \frac{.7854 \times D^2 \times L}{231} = \frac{A \times L}{231}$$

Where D, the diameter and L, the length are in inches

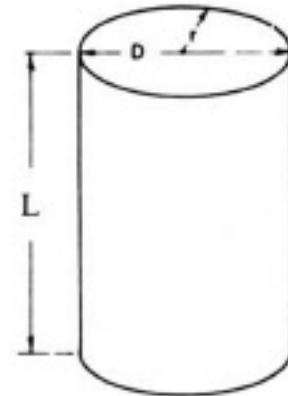

The equation for computation of volume when the tank is less than half full is shown below. When more than half full, compute the full capacity of the tank as noted above; consider the shaded portion to represent the unfilled portion at the top of the tank and compute the volume as indicated below; then deduct the volume determined for the unfilled portion from the total volume of the tank to arrive at the volume of the filled portion.

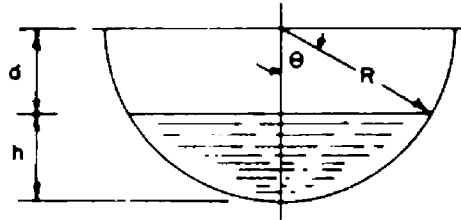

Calculate the value of  $\theta$  where  $\text{Cos } \theta = \frac{d}{R} = \frac{R - h}{R}$

Then Area =  $A = \pi R^2 \frac{\theta}{180} - R \sin \theta (R - h)$

Volume =  $V = L \frac{\left[ \pi R^2 \frac{\theta}{180} - R \sin \theta (R - h) \right]}{231}$  gallons

Where A is the cross section area of the filled portion of the tank measured in square inches

V is the volume of the filled portion of the tank, measured in U.S. gallons of 231 cu. inches

L is the length of the tank in inches

D is the diameter of the tank in inches

R is the radius of the tank in inches or half the diameter

h is the depth of the liquid, in inches

d is R minus h, in inches

**TABLE 3**  
*Capacity of Cylindrical Tanks in Horizontal Position*

% Depth Filled	% of Capacity	% Depth Filled	% of Capacity	% Depth Filled	% of Capacity	% Depth Filled	% of Capacity
1	.20	26	20.73	51	51.27	76	81.50
2	.50	27	21.86	52	52.55	77	82.60
3	.90	28	23.00	53	53.81	78	83.68
4	1.34	29	24.07	54	55.08	79	84.74
5	1.87	30	25.31	55	56.34	80	85.77
6	2.45	31	26.48	56	57.60	81	86.77
7	3.07	32	27.66	57	58.86	82	87.76
8	3.74	33	28.84	58	60.11	83	88.73
9	4.45	34	30.03	59	61.36	84	89.68
10	5.20	35	31.19	60	62.61	85	90.60
11	5.98	36	32.44	61	63.86	86	91.50
12	6.80	37	33.66	62	65.10	87	92.36
13	7.64	38	34.90	63	66.34	88	93.20
14	8.50	39	36.14	64	67.56	89	94.02
15	9.40	40	37.36	65	68.81	90	94.80
16	10.32	41	38.64	66	69.97	91	95.50
17	11.27	42	39.89	67	71.16	92	96.26
18	12.24	43	41.14	68	72.34	93	96.93
19	13.23	44	42.40	69	73.52	94	97.55
20	14.23	45	43.66	70	74.69	95	98.13
21	15.26	46	44.92	71	75.93	96	98.66
22	16.32	47	46.19	72	77.00	97	99.10
23	17.40	48	47.45	73	78.14	98	99.50
24	18.50	49	48.73	74	79.27	99	99.80
25	19.61	50	50.00	75	80.39	100	100.00

**TABLE 4**  
*Volume of Cylindrical Tanks in Gallons per Foot of Depth  
 in a Vertical Position*

Diameter in		U. S. Gallons	Diameter in		U. S. Gallons	Diameter in		U. S. Gallons
Feet	Inches		Feet	Inches		Feet	Inches	
1	0	5.875	3	6	71.97	6	0	211.5
1	1	6.895	3	7	75.44	6	3	220.5
1	2	7.997	3	8	78.99	6	6	248.2
1	3	9.180	3	9	82.62	6	9	267.7
1	4	10.44	3	10	86.33	7	0	287.9
1	5	11.79	3	11	90.13	7	3	308.8
1	6	13.22	4	0	94.00	7	6	330.5
1	7	14.73	4	1	97.96	7	9	352.9
1	8	16.32	4	2	102.0	8	0	376.0
1	9	17.99	4	3	106.1	8	3	399.9
1	10	19.75	4	4	110.3	8	6	424.5
1	11	21.58	4	5	114.6	8	9	449.8
2	0	23.50	4	6	119.0	9	0	475.9
2	1	25.50	4	7	123.4	9	3	502.7
2	2	27.58	4	8	127.9	9	6	530.2
2	3	29.74	4	9	132.6	9	9	558.5
2	4	31.99	4	10	137.3	10	0	587.5
2	5	34.31	4	11	142.0	10	3	617.3
2	6	36.72	5	0	146.9	10	6	647.7
2	7	39.21	5	1	151.8	10	9	679.0
2	8	41.78	5	2	156.8	11	0	710.9
2	9	44.43	5	3	161.9	11	3	743.6
2	10	47.16	5	4	167.1	11	6	777.0
2	11	49.98	5	5	172.4	11	9	811.1
3	0	52.88	5	6	177.7	12	0	846.0
3	1	55.86	5	7	183.2	12	3	881.6
3	2	58.92	5	8	188.7	12	6	918.0
3	3	62.06	5	9	194.2	12	9	955.1
3	4	65.28	5	10	199.9			
3	5	68.58	5	11	205.7			

## RECTANGULAR TANK CAPACITIES (By Calculation)

Where L is the length

w is the width

h is the height

If L, w, and h are measured in inches,

$$\text{Volume} = \frac{L \times w \times h}{231} \text{ Gallons}$$

Note: there are 231 cubic inches  
in one gallon

If L, w, and h are measured in feet.

$$\text{Volume} = L \times w \times h \times 7.48 \text{ Gallons}$$

Note: one cubic foot contains  
7.48 gallons

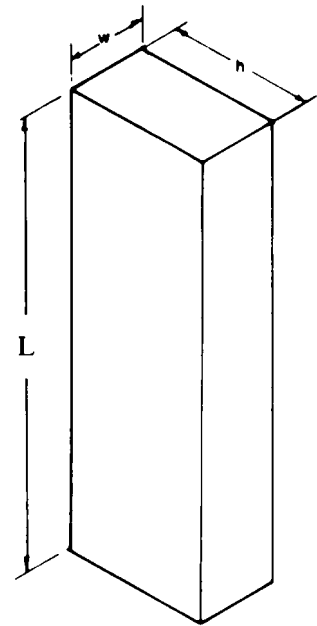

### *SAMPLE PROBLEM*

Let L equal 60"

w equal 12"

h equal 24"

Find volume in gallons

$$\begin{aligned} \text{Volume} &= \frac{60 \times 12 \times 24}{231} \\ &= \frac{17,280}{231} \text{ Gallons} \\ &= 74.8 \text{ (Ans.)} \end{aligned}$$

### *SAMPLE PROBLEM*

Let L equal 5 ft.

w equal 1 ft.

h equal 2 ft.

Find volume in gallons

$$\begin{aligned} \text{Volume} &= 5 \times 1 \times 2 \times 7.48 \\ &= 74.8 \text{ Gallons (Ans.)} \end{aligned}$$





RECTANGULAR OR SQUARE TAPERED TANK CAPACITIES  
 (Frustrum of Pyramid)  
 (By Calculation)

$$\text{Volume in Gallons} = \frac{h}{3} [(Area_{Base} + Area_{Top}) + \sqrt{(Area_{Base} + Area_{Top})}] \times 7.48$$

Providing h and Areas are in Sq. Feet

$$\text{Volume} = \frac{h^3 [(Area_{Top} + Area_{Base}) + \sqrt{(Area_{Top} + Area_{Base})}]}{3 \times 231}$$

Providing the dimensions are in inches

*SAMPLE PROBLEM*

- Let x be 12"
- y be 12"
- w be 18"
- L be 18"
- h 24"

$$\begin{aligned} \text{Volume} &= \frac{24 [(12 \times 12) + (18 \times 18) + \sqrt{144 \times 324}]}{3 \times 231} \\ &= 23.7 \text{ gal.} \end{aligned}$$

If feet are used, the following solution is in order

$$\begin{aligned} \text{Volume} &= \frac{2}{3} [(1 + 2^{1/4}) + \sqrt{1 \times 2^{1/4}}] \times 7.48 \\ &= 23.7 \text{ gal.} \end{aligned}$$

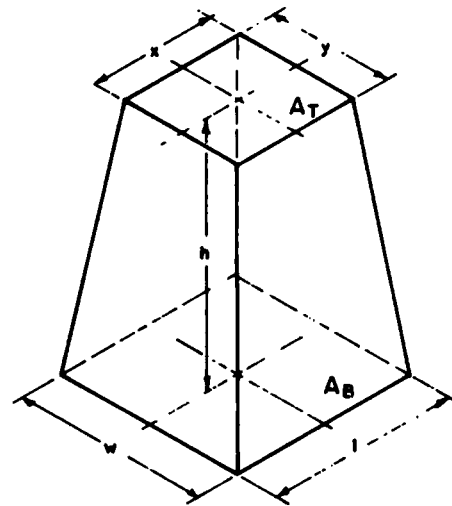

ROUND TAPERED TANK CAPACITIES  
(Frustrum of Cone)  
(By Calculation)

$$\text{Volume} = \frac{h^3}{3} \frac{[(\text{Area}_{\text{Top}} + \text{Area}_{\text{Base}}) + \sqrt{(\text{Area}_{\text{Top}} + \text{Area}_{\text{Base}})}]}{231}$$

If inches are used.

$$\text{Volume} = \frac{h}{3} [(\text{Area}_{\text{Base}} + \text{Area}_{\text{Top}}) + \sqrt{(\text{Area}_{\text{Base}} + \text{Area}_{\text{Top}})}] \times 7.48$$

If feet are used.

*SAMPLE PROBLEM*

Let d be 12", or 2 ft.

D be 36", or 3 ft.

h be 48", or 4 ft.

Find volume in gallons.

$$\text{Volume} = \frac{48}{3} \frac{[(\pi \times 12^2) + (\pi \times 18^2) + \sqrt{\pi \times 12^2 \times 18^2}]}{231}$$

Where dimensions are in inches

$$\text{Volume} = \frac{4}{3} [(\pi \times 12^2) + (\pi \times 1\frac{1}{2}^2) + \sqrt{(\pi \times 1^2) \times (\pi \times \frac{1}{2}^2)}] \times 7.48$$

Where dimensions are in feet

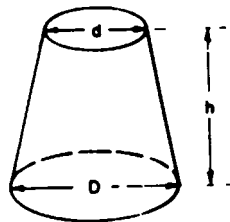

**TABLE 6***Finding the Length of Pipe Needed to Connect Two Ends, Offset, and in the Same Plane (Figure 3)*

Degree of Offset "a"	When A = 1 B is	When B = 1 A is	When A = 1 C is
72° ( $\frac{1}{5}$ bd)	.3249	3.077	1.0515
60° ( $\frac{1}{6}$ bd)	.5773	1.732	1.1547
45° ( $\frac{1}{8}$ bd)	1.0000	1.000	1.4142
22 1/2° ( $\frac{1}{16}$ bd)	2.414	.4142	2.6131

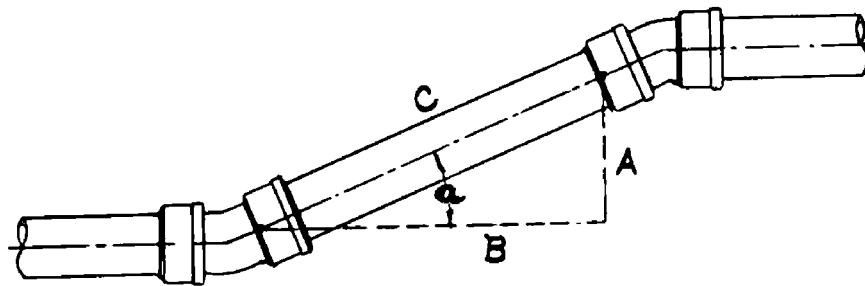

Figure 3—SIMPLE OFFSET

EXAMPLE: When Angle  $a = 22.50^\circ$  and Side  $A = 12''$   
 Side  $C = 2.6131 \times 12''$   
 $C = 31.36''$

When Angle  $a = 45^\circ$  and Side  $A = 12''$   
 Side  $C = 1.4142 \times 12''$   
 $C = 16.97''$

**TABLE 7**  
***Circumferences and Areas of Circles***

Of One Inch					Of Inches or Feet				
Fract.	Decimal	Circ.	Area	Dia.	Circ.	Area	Dia.	Circ.	Area
1/64	.015625	.04909	.00019	1	3.1416	.7854	64	201.06	3216.99
1/32	.03125	.09818	.00077	2	6.2832	3.1416	65	204.20	3318.31
3/64	.046875	.14726	.00173	3	9.4248	7.0686	66	207.34	3421.19
1/16	.0625	.19635	.00307	4	12.5664	12.5664	67	210.49	3525.65
5/64	.078125	.24545	.00479	5	15.7080	19.635	68	213.63	3631.68
3/32	.09375	.29452	.00690	6	18.850	28.274	69	216.77	3739.28
7/64	.109375	.34363	.00939	7	21.991	38.485	70	219.91	3848.45
1/8	.125	.39270	.01227	8	25.133	50.266	71	223.05	3959.19
9/64	.140625	.44181	.01553	9	28.274	63.617	72	226.19	4071.50
5/32	.15625	.49087	.01917	10	31.416	78.540	73	229.34	4185.50
11/64	.171875	.53999	.02320	11	34.558	95.033	74	232.48	4300.84
3/16	.1875	.58905	.02761	12	37.699	113.1	75	235.62	4417.86
13/64	.203125	.63817	.03241	13	40.841	132.73	76	238.76	4536.46
7/32	.21875	.68722	.03757	4	43.982	153.94	77	241.90	4656.63
15/64	.234375	.73635	.04314	15	47.124	176.71	78	245.04	4778.36
1/4	.25	.78540	.04909	16	50.265	201.06	79	248.19	4901.67
17/64	.265625	.83453	.05542	17	53.407	226.98	80	251.33	5026.55
9/32	.28125	.88357	.06213	18	56.549	254.47	81	254.47	5153.0
10/64	.296875	.93271	.06922	19	59.690	283.53	82	257.61	5281.02
5/16	.3125	.98175	.07670	20	63.832	314.16	83	260.75	5410.61
21/64	.328125	1.0309	.08456	21	65.973	346.36	84	263.89	5541.77
11/32	.34375	1.0799	.09281	22	69.115	380.13	85	267.04	5674.50
23/64	.35975	1.1291	.10144	23	72.257	415.48	86	270.18	5808.80
3/8	.375	1.1781	.11045	24	75.398	452.39	87	273.32	5944.68
25/64	.390625	1.2273	.11984	25	78.540	490.87	88	276.46	6082.12
13/32	.40625	1.2763	.12962	26	81.681	530.93	89	279.60	6221.14
27/64	.421875	1.3254	.13979	27	84.823	572.56	90	282.74	6361.71
7/16	.4375	1.3744	.15033	28	87.965	615.75	91	285.88	6503.88
29/64	.453125	1.4236	.16126	29	91.106	660.52	92	289.03	6647.61
15/32	.46875	1.4726	.17257	30	94.248	706.86	93	292.17	6792.91
31/64	.484375	1.5218	.18427	31	97.389	754.77	94	295.31	6939.78
1/2	.5	1.5708	.19635	32	100.53	804.25	95	298.45	7088.22

(Continued Next page)

**TABLE 7 (Continued)**  
*Circumferences and Areas of Circles*

Of One Inch					Of Inches or Feet				
Fract.	Decimal	Circ.	Area	Dia.	Circ.	Area	Dia.	Circ.	Area
<sup>33</sup> / <sub>64</sub>	.515625	1.6199	.20880	33	103.67	855.30	96	301.59	7238.23
<sup>17</sup> / <sub>32</sub>	.53125	1.6690	.22166	34	106.81	907.92	97	304.73	7339.81
<sup>35</sup> / <sub>64</sub>	.546875	1.7181	.23489	35	109.96	962.11	98	307.88	7542.96
<sup>9</sup> / <sub>16</sub>	.5625	1.7671	.24850	36	113.10	1017.88	99	311.02	7697.69
<sup>37</sup> / <sub>64</sub>	.578125	1.8163	.26248	37	116.24	1075.21	100	314.16	7853.98
<sup>19</sup> / <sub>32</sub>	.59375	1.8653	.27688	38	119.38	1134.11	101	317.30	8011.85
<sup>30</sup> / <sub>64</sub>	.609375	1.9145	.29164	39	122.52	1194.59	102	320.44	8171.28
<sup>5</sup> / <sub>8</sub>	.625	1.9635	.30680	40	125.66	1256.64	103	323.58	8332.29
<sup>41</sup> / <sub>64</sub>	.640625	2.0127	.32232	41	128.81	1320.25	104	326.73	8494.87
<sup>21</sup> / <sub>32</sub>	.65625	2.0617	.33824	42	131.95	1385.44	105	327.87	8659.01
<sup>43</sup> / <sub>64</sub>	.671875	2.1108	.35453	43	135.09	1452.20	106	333.01	8824.73
<sup>11</sup> / <sub>16</sub>	.6875	2.1598	.37122	44	138.23	1520.53	107	336.15	1992.02
<sup>45</sup> / <sub>64</sub>	.703125	2.2090	.38828	45	141.37	1590.43	108	339.29	9160.88
<sup>23</sup> / <sub>32</sub>	.71875	2.2580	.40574	46	144.51	1661.90	109	342.43	9331.32
<sup>47</sup> / <sub>64</sub>	.734375	2.3072	.42356	47	147.65	1734.94	110	345.58	9503.32
<sup>3</sup> / <sub>4</sub>	.75	2.3562	.44179	48	150.80	1809.56	111	348.72	9676.89
<sup>49</sup> / <sub>64</sub>	.765625	2.4050	.45253	49	153.94	1885.74	112	351.86	9853.03
<sup>25</sup> / <sub>32</sub>	.78125	2.4544	.47937	50	157.08	1963.50	113	355.0	10028.75
<sup>51</sup> / <sub>64</sub>	.796875	2.5036	.49872	51	160.22	2042.82	114	358.14	10207.03
<sup>13</sup> / <sub>16</sub>	.8125	2.5525	.51849	52	163.36	2123.72	115	361.28	10386.89
<sup>53</sup> / <sub>64</sub>	.828125	2.6017	.53862	53	166.50	2206.18	116	364.42	10568.32
<sup>27</sup> / <sub>32</sub>	.84375	2.6507	.55914	54	169.65	2290.22	117	367.57	10751.32
<sup>55</sup> / <sub>64</sub>	.859375	2.6999	.58003	55	172.79	2375.83	118	370.71	10935.88
<sup>7</sup> / <sub>8</sub>	.875	2.7489	.60123	56	175.93	2463.01	119	373.85	11122.02
<sup>57</sup> / <sub>64</sub>	.890625	2.7981	.62298	57	179.07	2551.76	120	376.99	11309.73
<sup>29</sup> / <sub>32</sub>	.90625	2.8471	.64504	58	182.21	2642.08	121	380.13	11499.01
<sup>59</sup> / <sub>64</sub>	.921875	2.8963	.66746	59	185.35	2733.97	122	383.27	11689.07
<sup>15</sup> / <sub>16</sub>	.9375	2.9452	.69029	60	188.50	2827.43	123	386.42	11882.29
<sup>61</sup> / <sub>64</sub>	.953125	2.9945	.71349	61	191.64	2922.47	124	389.56	12076.28
<sup>31</sup> / <sub>32</sub>	.96875	3.0434	.73708	62	194.78	3019.07	125	392.70	12271.85
<sup>63</sup> / <sub>64</sub>	.984375	3.0928	.76097	63	197.92	3117.25	126	395.84	12468.98

**TABLE 8**  
*Cast Iron Soil Pipe Equivalents*

	1½	2	3	4	5	6	8	10	12	15
1½	1	1.8	4	7.1	10.8	15.7	28.	44.4	63.4	100
2		1	2.3	4	6.1	8.8	15.8	25	35.6	56.3
3			1	1.8	2.7	3.9	7	11.1	15.8	25
4				1	1.5	2.2	3.9	6.3	8.9	14.1
5					1	1.4	2.6	4.1	5.8	9.2
6						1	1.8	2.8	4	6.4
8							1	1.6	2.3	3.6
10								1	1.4	2.3
12									1	1.6
15										1

EXAMPLE: A 4" cast iron soil pipe is equivalent to how many 2" cast iron soil pipe? In the vertical column under 4", and opposite 2", read the equivalent which is 4: This means that four 2" cast iron soil pipe are the equivalent of one 4" cast iron soil pipe in inside cross-sectional area.

**TABLE 9**  
*The Conversion of Fractions to Decimals*

Fractions	Decimal	Fractions	Decimal
1/64	.015625	33/64	.515625
1/32	.03125	17/32	.53125
3/64	.046875	35/64	.546875
1/16	.0625	9/16	.5625
5/64	.078125	37/64	.578125
3/32	.09375	19/32	.59375
7/64	.109375	38/64	.609375
1/8	.125	5/8	.625
9/64	.140625	41/64	.640625
5/32	.15625	21/32	.65625
11/64	.1719	43/64	.67187
3/16	.1875	11/16	.6875
13/64	.2031	45/64	.70312
7/32	.2188	23/32	.71875
15/64	.234375	47/64	.734375
1/4	.25	3/4	.75
17/64	.265625	49/64	.765625
9/32	.28125	25/32	.78125
19/64	.296875	51/64	.796875
5/16	.3125	13/10	.8125
21/64	.328125	53/64	.828125
11/32	.34375	27/32	.84375
23/64	.359375	55/64	.859375
3/8	.375	7/8	.875
25/64	.398625	57/64	.890625
13/32	.40625	29/32	.90625
27/64	.421875	60/64	.921875
7/16	.4375	15/16	.9375
20/64	.453125	61/64	.953125
15/32	.46875	31/32	.96875
31/64	.484375	63/64	.984375
1/2	.50	1	1.000000

**TABLE 10**  
*Decimal Equivalents of Inches in Feet and Yards*

Inches	Feet	Yards
1	.0833	.0278
2	.1667	.0556
3	.2500	.0833
4	.333	.1111
5	.4166	.1389
6	.5000	.1667
7	.5833	.1944
8	.6667	.2222
9	.7500	.2500
10	.8333	.2778
11	.9166	.3056
12	1.000	.3333

**TABLE 11**  
*Solution of the Right Triangle*

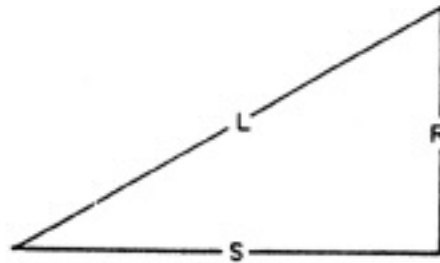

To find side	When you know side	Multiply side	For 45 Ells-By	For 22 1/2 Ells-By	For 67 1/2 Ells-By	For 72 Ells-By	For 60 Ells-By	For 80 Ells-By
L	S	S	1.4142	2.6131	1.08	1.05	1.1547	2.00
S	L	L	.707	.3826	.92	.95	.866	.50
R	S	S	1.000	2.4142	.414	.324	.5773	.1732
S	R	R	1.000	.4142	2.41	3.07	1.732	.5773
L	R	R	1.4142	1.0824	2.61	3.24	2.00	1.1547
R	L	L	.7071	.9239	.38	.31	.50	.866



**TABLE 12**  
**Conversion Factors**

	MULTIPLY NUMBER OF	BY	TO OBTAIN EQUIVALENT NUMBER OF	MULTIPLY NUMBER OF	BY	TO OBTAIN EQUIVALENT NUMBER OF
Linear measures	Millimetres (mm.) Centimetres (cm.)	0.03937 0.3937	Inches (in.) Inches	Inches	{ 23.40 2.340	Millimetres Centimetres
	Metres (m.) Kilometres	{ 3.2808 1.0936 0.3468 0.6214 0.5396	Feet (ft.) Yards (yd.) Fathoms Miles (land) Miles (sea <sup>1</sup> )	Feet Yards Fathoms (6 ft.) Cables (200 yd.) Miles (land: 5,880 ft.) Miles (sea: 6,080 ft.)	{ 30.48 0.3048 0.9144 1.8288 182.880 1.6093 1.8332 }	Centimetres Metres Metres Kilometres
Square measures	Sq. millimetres Sq. millimetres Sq. metres	0.001550 0.1550 { 10.7639 1.1960 2.4711 247.105 0.3861	Sq. inches Sq. inches Sq. feet Sq. yards Acres Acres Sq. miles	Sq. inches Sq. feet Sq. yards Acres Sq. miles	{ 643.160 6.4516 929.030 0.09290 0.8361 4,046.86 0.4047 0.004047 2.3900	Sq. millimetres Sq. centimetres Sq. centimetres Sq. metres Sq. metres Sq. metres Hectares Sq. kilometres Sq. kilometres
	Hectares (hs.) Sq. kilometres					
Cubic measures and Capacities	Cu. centimetres (c.c.) Litres (lit.) (1,000 c.c.) Hectolitres (hl.) Cu. metres (cu. m.)	{ 0.06102 61.0238 0.03531 0.2642 .02200 26.4178 31.9976 2.8378 2.7497 35.3147 264.178 219.976 6.1104	Cu. inches Cu. inches Cu. feet Gallons (US) Gallons (Imp.) Gallons (US) Gallons (Imp.) Bushels (US) Bushels (Imp.) Cu. feet Gallons (US) Gallons (Imp.) Bulk Barrels	Cu. inches Pints (Imp.) Pints (Imp.) Gallons (Imp.) Gallons (US) Cu. feet Bushels (Imp.) (US) Gallons (Imp.) (US) Bulk barrels	{ 16.3871 34.6775 0.3882 4.5460 3.7853 28.3268 0.3637 0.3524 1.2010 0.8327 36.0000 43.2343 0.1637	Cu. centimetres Cu. inches Litres Hectolitres Gallons (US) Gallons (Imp.) Gallons (US) Cu. metres
Weights	Grams (gm.) Kilograms (kg.) Metric quintals (q.) Metric tons	{ 0.03527 0.03215 2.2046 220.462 3,304.62 1.1023 0.9842	Ounces (av. <sup>2</sup> ) (os.) Ounces (troy <sup>2</sup> ) (os. tr.) Pounds (lb.) <sup>2</sup> Pounds <sup>3</sup> Short tons Long tons	Ounces (av. <sup>2</sup> ) Ounces (troy <sup>2</sup> ) Ounces (av. <sup>2</sup> ) Pounds <sup>2</sup> Hundred weights (cuf.) (112 lb.) Long tons (2,240 lb.) Short tons (2,000 lb.)	{ 28.3495 31.1035 0.9115 453.392 0.4336 0.0500 0.3080 1.1200 1.0161 0.8929 0.9072	Grams Ounces (troy <sup>2</sup> ) Grams Kilograms Long tons Metric quintals Short tons Metric tons Long tons Metric tons
Speed and Energy	Kilometres/hour Cheval vapeur	{ 0.6214 0.3396 0.9863	Miles/hour Knots (sea miles/hour) Horsepower	Miles, hour Horsepower	{ 1.6093 0.8684 1.0139	Kilometres/ hour Knots Cheval vapour
Temperature	Centigrade 100° C. 30° C. 37° C.	9/5, and add 32° equals equals	Fahrenheit 212° F. 123° F. 98.6° F.	Fahrenheit 59° F 32° F	5/9, after subtracting 32° equals equals	Centigrade 15° C. 0° C.

<sup>2</sup> United Kingdom measure. An international nautical mile = 6,076.115 feet. <sup>3</sup> Avoirdupois. <sup>4</sup> Or foe.

**TABLE 13**  
*Miscellaneous Tables of Weights, Measures and Other Information*

**Square Measure**

144 inches .....	1 square foot
9 square feet .....	1 square yard
30¼ sq. yds. 272¼ sq. ft. ....	1 square rod
160 square rods .....	1 acre
640 acres .....	1 square mile

**Cubic Measure**

1728 cubic inches .....	1 cubic foot
1 cubic foot.....	7.4805 gallons
27 cubic feet .....	1 cubic yard
128 cubic feet .....	1 cord

**Dry Measure**

2 pints .....	1 quart
8 quarts .....	1 peck
4 pecks.....	1 bushel
1 bushel.....	1.24 cu. feet
1 bushel.....	2150.42 cu inches

**Liquid Measure**

4 gills .....	1 pint
2 pints .....	1 quart
4 quarts. ....	1 gallon
31½ gallons. ....	1 barrel
2 barrels .....	1 hogshead

**Linear Measure**

12 inches .....	1 foot
3 feet .....	1 yard
16½ feet .....	1 rod or pole
5½ yards.....	1 rod or pole
40 rods or poles .....	1 furlong
8 furlongs .....	1 statute mile
320 rods .....	1 mile
5280 feet .....	1 mile
4 inches .....	1 hand
7.92 inches.....	1 link
18 inches.....	1 cubit
1.15156 miles.....	1 knot or 1 nautical mile

**Weight – Avoirdupois or Commercial**

437.5 grains .....	1 ounce
16 ounces.....	1 pound
112 pounds .....	1 hundredweight
2000 pounds.....	1 net ton or 1 short ton
20 hundredweight.....	1 gross or long ton
20 hundredweight .....	2240 pounds
2204.6 pounds.....	1 metric ton

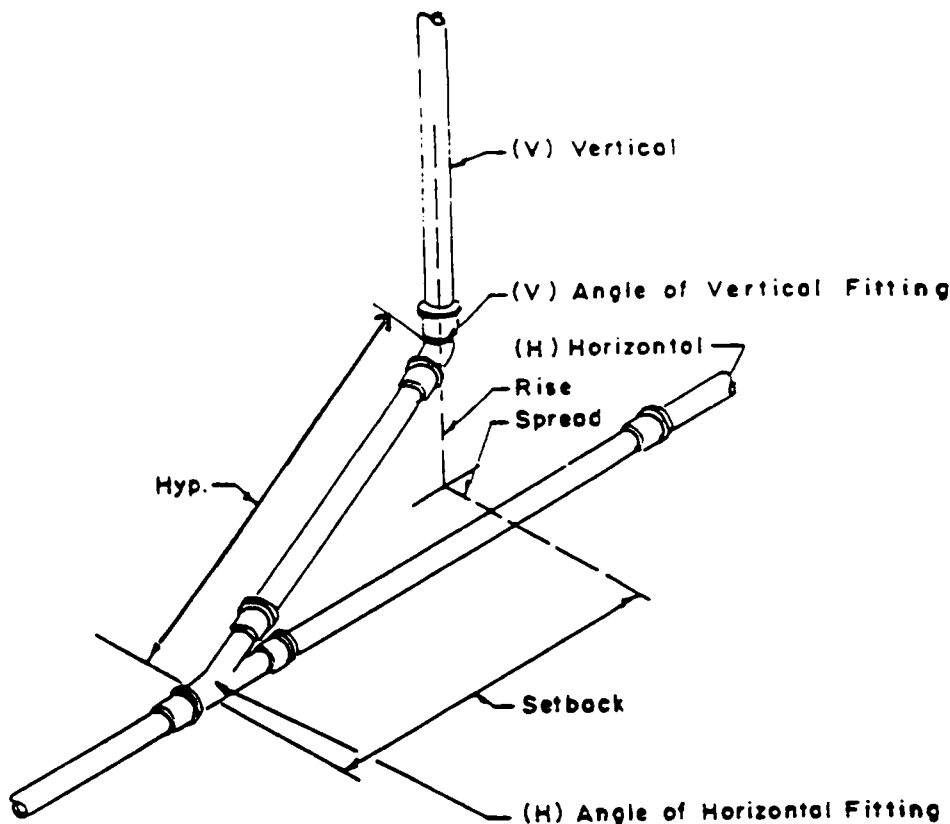

Figure 5—Explanation of the Compound Offset Table.

**TABLE 14**  
*Compound Offsets*

		60° ( $\frac{1}{6}$ bd)V	45° ( $\frac{1}{8}$ bd)V	72° ( $\frac{1}{5}$ bd)V	60° ( $\frac{1}{6}$ bd)V	45° ( $\frac{1}{8}$ bd)V	72° ( $\frac{1}{5}$ bd)V	60° ( $\frac{1}{6}$ bd)V	
		45° ( $\frac{1}{5}$ bd)H	72° ( $\frac{1}{5}$ bd)H	60° ( $\frac{1}{6}$ bd)H	60° ( $\frac{1}{6}$ bd)H	60° ( $\frac{1}{6}$ bd)H	45° ( $\frac{1}{8}$ bd)H	45° ( $\frac{1}{8}$ bd)H	
Spread	X	1.24	1.57	1.23	1.41	2.	1.57	2.	= Hyp
Rise	X	2.	1.41	3.323	2.	1.41	3.358	2.	= Hyp
Setback	X	3.25	3.25	1.96	2.	2.	1.41	1.41	= Hyp
Hyp	X	.807	.684	.81	.71	.5	.634	.5	= Spread
Rise	X	1.61	.90	2.66	1.41	.707	2.	1.	= Spread
Setback	X	2.62	2.	1.60	1.41	1.	.90	.71	= Spread
Hyp	X	.5	.70	.305	.5	.71	.307	.5	= Rise
Spread	X	.62	1.11	.3697	.71	1.41	.469	1.	= Rise
Setback	X	1.62	2.29	.584	1.	1.41	.437	.71	= Rise
Hyp	X	.307	.307	.587	.5	.5	.71	.71	= Setback
Spread	X	.38	.48	.625	.71	1.	1.114	1.41	= Setback
Rise	X	.615	.437	1.70	1.	.71	2.377	1.41	= Setback

## BIBLIOGRAPHY

- American Association of State Highway and Transportation Officials Pamphlet T-99, 1981 edition.
- American Iron and Steel Institute: *Annual Statistical Report*, editions 1916-1942.
- American Public Works Association, *The Construction of Sanitary Sewers*, Chicago, 1958.
- American Society for Testing and Materials: *Standard Method for Transverse Testing of Gray Cast Iron*, ASTM Designation: A 438, Philadelphia, *Specifications for Gray Iron Castings for Valves, Flanges and Pipe Fittings*, ASTM Designations: A126, Philadelphia. *Specifications for Rubber Gaskets for Cast Iron Soil Pipe and Fittings*, ASTM Designation: C 564, Philadelphia
- Babitt, H.E., Baumann, E.R. and Hayward, H.N.: *The Corrosion of Copper Tube Used in Soil- Stack Installations*, University of Illinois Engineering Experiment Station, Bulletin No. 419.
- Babbitt, H.E. and Caldwell, D.H.: *Turbulent Flow of Sludges in Pipes*, University of Illinois Engineering Experiment Station, Bulletin No. 323.
- Brown, T.C. Sr., P.E., "Specifying Soil Pipe Systems for a Quieter Installation," *Construction Specifier*, February, 1981, pp. 15-20.
- Cast Iron Pipe Research Association: *Handbook of Cast Iron Pipe*, Second Edition, Chicago, 1952.
- Cast Iron Soil Pipe Institute, *Hubless Cast Iron Sanitary System with Pipe and Fittings, Specification Data, Standard No. 301*, Washington, D.C.
- Cast Iron Soil Pipe Institute (CISPI): *Recommendations for Deep Burial of Cast Iron Soil Pipe*, Washington, D.C., 1983.
- Clark, Victor S.: *History of Manufacturers in the United States*, Volume III 1893-1928, New York, McGraw-Hill Book Company, Inc., 1929.
- History of Manufacturers in the United States*, Volume III 1893-1928, New York, McGraw- Hill Book Company, Inc., 1929, pp. 127-128.
- Crane Company, Engineering and Research Division, *Flow of Fluids, through Valves, Fittings and Pipe*, Chicago, 1942 and 1957.
- Crocker, S.: *Piping Handbook*, 4th ed., New York, McGraw-Hill Book Company, 1945.
- Davis, Paul G.: *Plumbing, Heating and Piping Estimators Guide*, New York, McGraw-Hill Book Company, 1960.
- Dawson, F.M. and Kalinske, A.A.: "Hydraulics and Pneumatics of the Plumbing Drainage System," *Technical Bulletin, No. 2*, National Association of Master Plumbers of the United States, Inc., Washington, D.C. 1939.
- E.I. du Pont de Nemours and Company, Elastometer Chemicals Department, *The Language of Rubber*, Wilmington, Delaware, 1963.
- The Engineer*, Vol. SCI, London, January to June, 1901, pp. 157, 232, 258, 268, 313, 389, 443, 533, 534, 587.
- Fairbanks Morse and Company: *Hydraulic Handbook*, 2nd ed., Chicago, 1956.
- French, John L.: "Stack Venting of Plumbing Fixtures," in U.S. Bureau of Standards, *Building Material and Structure Report BMS 118*, Washington, D.C., U.S. Government Printing Office, 1950.
- French, Eaton and Wyly: "Wet Venting of Plumbing Fixtures," in U.S. Bureau of Standards, *Building Material and Structure Report BMS 119*, Washington, D.C., U.S. Government Printing Office, 1951.

- General Services Administration: *Federal Specifications, Iron Castings, Gray*, Federal Specification QQ-I-652b, Washington, D.C., U.S. Government Printing Office, February 17, 1964. *Federal Specification, Pipe and Pipe Fittings, Cast-Iron, Soil*, Federal Specification WW-P-401E, Washington, D.C., U.S. Government Printing Office, October 24, 1974.
- Gray Iron Founders' Society: *Casting Design, Volume II: Taking Advantage of the Experience of Patternmaker and Foundryman to Simplify the Designing of Castings*, Cleveland, 1962. *Straight Line to Production: The Eight Casting Processes Used to Produce Gray Iron Castings*, Cleveland, 1962.
- Henderson, G.E. and Roberts, Jane A.: *Pumps and Plumbing for the Farmstead*, Tennessee Valley Authority Publication, Washington, D.C., U.S. Government Printing Office, 1948.
- Housing and Home Finance Agency, Division of Housing Research, *Performance of Plumbing Fixtures and Drainage Stacks*, Research Paper No. 31, 1954.
- Imhoff, Karl and Fair, Gordon M.: *Sewage Treatment*, 2nd ed., New York, John Wiley and Sons, Inc., 1956.
- "Infiltration into Sewers Can Cost Lots of Money," *Public Works*, August, 1958.
- Kellogg (M.W.) Company: *Design of Piping Systems*, New York, John Wiley and Sons, Inc., 1964.
- King, Horace W. and Brater, Ernest F.: *Handbook of Hydraulics for the Solution of Hydrostatic and Fluid-Flow Problems*, 5th edition, New York: McGraw-Hill Book Company, Inc., 1963, p. 6-1.
- King, Horace W., Wisler, Chest O. and Woodburn, James G.: *Hydraulics*, 5th edition, New York: John Wiley and Sons, Inc., 1948, P. 175.
- Koelble, Frank T., ed.: *Cast Iron Soil Pipe and Fittings Engineering Manual*, Washington, D.C., Cast Iron Soil Pipe Institute, 1972.
- Malleable Founders' Society, *American Malleable Iron Handbook*, Cleveland, 1944.
- Manly, M.P.: *Plumbing Guide*, Wilmette, Illinois, Frederick J. Drake and Company, 1954.
- Manning, Robert: *Flow of Water in Open Channels and Pipes*, Trans, Inst. Civil Engrs., Vol. 20, Ireland, 1890.
- Manners, David X.: *Plumbing and Heating Handbook*, Greenwich, Connecticut, Fawcett Books, 1960.
- Marston, A.: "The Theory of Loads on Pipes in Ditches and Tests of Cement and Clay Drain Tile and Sewer Pipe," *Iowa State University Engineering Experiment Station, Bulletin 31*, 1913.
- "Supporting Strength of Sewer Pipe in Ditches and Methods of Testing Sewer Pipe in Laboratories to Determine Their Ordinary Supporting Strength," *Iowa State University Engineering Experiment Station, Bulletin 47*, 1917.
- Matthias, A.J. Jr.: *Plumbing*, Chicago, American Technical Society, 1948.
- Merritt, Frederick, S., ed.: *Building Construction Handbook*, New York, McGraw-Hill Book Company, 1958.
- National Academy of Sciences: "Cathodic Protection," *Federal Construction Council Technical Report No. 32*, Washington, D.C., National Research Council Publication No. 741.
- "Criteria for the Acceptance of Cast Iron Soil Pipe," Publication 836, *Federal Construction Council Technical Report No. 40*, Washington, D.C., 1960.
- National Tank and Pipe Company: *Wood Pipe Handbook*, Portland, 1945.
- Noble, Henry Jeffers: "Development of Cast Iron Soil Pipe in Alabama," Supplement to *Pig Iron Rough Notes*, Birmingham, Sloss-Sheffield Steel and Iron Company, January 1941.
- Plum, Svend; *Plumbing Practice and Design*, Vol. I, New York, John Wiley and Sons, Inc., 1943.

- Polysonics Acoustical Engineers, *Noise and Vibration Characteristics of Soil Pipe Systems* (Job No. 1409, Report No. 1578 for the Cast Iron Soil Pipe Institute), Washington, D.C.: Polysonics Acoustical Engineers, June 1970.
- Geological Survey, Water Resources Division, *A Study of Detergent Pollution in Ground Water*, Washington, D.C., 1959.
- U.S. War Department: *Plumbing Repairs and Utilities*, TM 5-619, Washington, D.C., U.S. Government Printing Office, 1945.
- Watkins, R.K.: *Principles of Structural Performance of Buried Pipes*, Utah State University Printing Services, 1977.
- Wright, Lawrence: *Clean and Decent*, New York, The Viking Press, 1960.
- Wyly, Robert S.: *A Review of the Hydraulics of Circular Sewers in Accordance With the Manning Formula*; paper presented at 54th Annual Meeting of the American Society of Sanitary Engineering, Oct. 9–14, 1960, Washington, D.C.: U.S. Department of Commerce, National Bureau of Standards, 1960, p.1.
- Wyly and Eaton: “Capacities of Plumbing Stacks in Buildings,” in U.S. Bureau of Standards, *Building Material and Structure Report BMS 132*, Washington, D.C., U.S. Government Printing Office, 1952.
- York, J.E.: *Methods of Joining Pipe*, New York, The Industrial Press, 1949.
- Zozzora, Frank: *Engineering Drawing*, 2nd Ed., New York, McGraw-Hill Book Company, 1958.

# INDEX

## A

AB & I, 11

Abbreviations:  
     plumbing trades, used in, 154

Abrasion:  
     high velocity, and, 7  
     resistance to, cast iron soil pipe, of, 7

Absorption:  
     definition of, 158

Acoustical characteristics:  
     cast iron, of, 9  
     compression joint, of, 9, 123-131  
     copper pipe, of, 125  
     drainage, waste, and vent systems, of, 123  
     galvanized steel pipe, of, 125  
     hubless coupling, of, 127-128  
     lead and oakum joint, of, 127  
     neoprene, of, 128-129  
     plastic pipe, of, 130-131  
     test for, piping, in, 123-131

Air pressure test, piping systems, 57-58

Alabama:  
     foundry construction at Anniston, 1920's, 4  
     pig iron production in, 4-5  
     prominence in soil pipe, 4-5

American Gas Association, 154

American Iron and Steel Association, 1

American Iron and Steel Institute, 154

American National Standards Institute:  
     abbreviation for, 154  
     plumbing symbols adopted by, 164

American Petroleum Institute, 154

American Society of Civil Engineering, 154

American Society of Heating, Refrigeration,  
     and Air Conditioning Engineers, 154

American Society of Mechanical Engineers, 154

American Society of Plumbing Engineers, 154

American Society of Sanitary Engineers, 154

American Society for Testing and Materials, 154

American Standards Association  
     (See American National  
     Standards Institute.), 154

American Water Works Association, 154

Anaerobic:  
     definition of, 158

Anchor:  
     definition of, 158

Anthracite coal:  
     iron ore reduction, use in, 2

Areas of circles, 182

## B

Backfill:  
     definition of, 158  
     placing of, 64

Backflow:  
     definition of, 158

Backflow preventer:  
     definition of, 158

Back-siphonage  
     definition of, 158

Backwater, 32

Backwater valve, 32

Base, plumbing-system:  
     definition of, 158

Beam stresses, 97

Bedding conditions:  
     earth loads, 71-87

Bell and spigot joint  
     (see Hub and Spigot joint)

Bituminous coal:  
     coke production, use in, 2

Bog ore:  
     pipe production, use in, 2  
     Weymouth, New Jersey, at 2

Branch plumbing-system:  
     definition of, 158

Bronze pipe, 1

Building codes (see Plumbing codes)

Building drain, cast iron:  
     connection to septic tank, 5  
     connection to sewer, 5  
     definition of, 159  
     sizing of, 60

Building sewer, cast iron:  
     city sewer, connection to, 61, 70

cleanouts for, 64  
 definition of, 61  
 excavation for, 61  
 installation of, 49  
 line, grade, and alignment of, 61, 64  
 maintenance of, 65  
 septic tank, connection to, 64  
 testing and inspection of, 64  
 velocity in, 61  
 Butt joints, 1

## C

- Carbon steel pipe:  
 comparative cost, condensate drain lines,  
 for, 137  
 condensate drain lines, use in, 137
- Cast iron:  
 inherent noise control qualities of, 9,  
 123-131  
 pipe, available sizes and types, 7-8  
 pipe, consensus standards for, 7-8, 142  
 pipe, availability and delivery time  
 required, 10  
 pipe, raw materials contained in, 13, 132  
 pipe, handling and method of shipment, 30  
 pipe, methods of cutting to length, 44  
 pipe, trenching recommendations, 71-87  
 pipe, compared to plastic installed  
 underground, 81-87  
 properties of, 6-8
- Cast Iron Pressure Pipe:  
 centrifugal casting of, 29  
 difference, soil pipe, from, 1  
 early history of, 1
- Cast Iron Soil Pipe Industry:  
 capacity of, 11-12  
 companies in, 11  
 emergence in the 1890's, 4  
 foundry locations, of, 11  
 geographic distribution of, 1890, 2-4  
 melting capacity, 1898, 4  
 number of foundries, 1894 and 1898, 4  
 strategic location of, 12  
 technological advances by, 29-31
- Cast Iron Soil Pipe Institute:  
 abbreviation for, 158  
 acoustical study, and, 123-131  
 member companies of, 11  
 "Cast-on-end-in-pit" principle, 2
- Casting:  
 centrifugal, 17  
 permanent mold, fittings for, 23-24  
 soil pipe and fittings of, 18-23  
 static, 18  
 technological advances in, 29-31
- Caulking:  
 definition of, 158
- Centrifugal casting:  
 description of, 17  
 illustration of, 17  
 introduction of, 4  
 molds for, 17-18  
 technological advance, and, 29
- Cesspool:  
 see Leaching Well
- Charcoal:  
 furnace plants, New Jersey, 2  
 iron ore reduction, use in, 2
- Charlotte Pipe and Foundry Company, 11
- Chelsea Water Company, 1  
 Trademark, xiv
- Circles:  
 areas of, 182  
 circumferences of, 182
- Circuit vents:  
 illustrations of, 40
- Circumferences of circles, 182
- Clamps, pipe (*see* Hangers, pipe)
- Clark, Victor S., 1
- Clay pipe, 1
- Cleanouts:  
 cast iron soil pipe, for, 36, 64
- Closet bends:  
 above ground, 53-54
- Coating, cast iron soil pipe and fittings: 24
- Coke:



- iron ore reduction, use in, 1
  - manufacture of cast iron soil pipe, used in, 15
  - Coliform bacteria:
    - definition of, 158
  - Commercial construction:
    - cast iron soil pipe, use in, 5
  - Common vent:
    - definition of, 162
  - Compound offsets:
    - data for, 189
  - Compression:
    - definition of, 158
  - Compression joint:
    - deflection of, 9
    - description of, 8-9
    - installation instructions for, 45-46
    - soundproofing qualities of, 9, 123
    - testing of systems installed with, 57-59
    - tests on, acoustical characteristics, for, 123-131
    - watermains, use in, 8-9
  - Condensate drain lines:
    - carbon steel pipe, and, 137
    - cast iron soil pipe, use for, 140
    - Du Pont Company, and, 137-140
    - installation of test materials for, 137-140
    - lead and oakum joint, and, 138
    - materials for, comparative cost of, 137-138
    - neoprene joint seals, and, 140
    - plastic pipe, tested for, 137-140
    - results of tests on, 140
    - stainless steel pipe, and, 137
    - temperatures in, 140
    - testing procedures for, 139-140
  - Conductor, plumbing system:
    - definition of, 158
  - Continuous vent:
    - definition of, 162
  - Cope, 19
  - Copper pipe:
    - tests on, acoustical characteristics, for, 125
  - Coremaking:
    - core room of foundry, in, 21
    - description of, 21
    - illustration of, 21
  - machinery for, 21
  - technological advances in, 30
  - Cores:
    - centrifugal casting, in, 17
    - dry sand, use prior to 1850, 2
    - fittings production, and, 21
    - green sand:
      - mechanization, and 2
      - production, 2
    - hand-ramming of, 29
    - permanent mold casting, in, 21, 23
    - preparation of, fittings for, 23-24
    - technological change in preparation of, 29
  - Corrosion:
    - caused by soils, 6-7
    - common forms of, 6-7
    - factors controlling the rate of, 6
    - resistance to, cast iron soil pipe of, 6-7
    - protection from 6, 66-69
    - stress-accelerated, 7
  - Cross connection:
    - definition of, 158
  - Cupola-furnace process
    - advances in, 29
    - automatic, controls in, 29
    - coke use in, 13, 15
    - description of, 13, 15
    - exterior, furnace of, 14, 29
    - illustration of, 14
    - iron use in, 15
    - limestone use in, 15
    - raw materials used in, 13, 15, 29
    - temperatures in, 15
    - water-cooling in, 13, 29
- D**
- Dead end, plumbing system, in:
    - definition of, 158
  - Decimal equivalents, 185
  - Decimals to fractions:
    - conversion of, 185
  - Definitions:
    - plumbing trades, used in, 158
  - Design of Sewers and Drains, 115
  - Design Soil Pressure, 147

Design Summary, Deep Burial 95  
 Developed length, pipe, of:  
   definition of, 158  
 Drag, 19  
 Drainage:  
   battery of fixtures, for, 36  
   building or house, definition of, 159  
   building sub-drains, 32  
   combined drains, definition of, 159  
   condensate drain lines, in, 137  
   drain, definition of, 159  
   house drain, invert of, 61  
   principles of, 32  
   roof, alternative means of, 32-35  
   roof drains:  
     layouts for, 33-35  
     sewer gas, and, 32  
   sanitary sewers, and, 32  
   storm:  
     cast iron used in, 5  
     definition of, 159  
   storm drains, traps and vents for, 32  
   sub-soil drains, 32  
   terminals, 32  
 Drains (*see* Drainage)  
 Dry weather flow, 159  
 Ductility:  
   definition of, 159  
 Dumping and Shoving, 151  
 Du Pont Company;  
   condensate drain lines tested by, 137-140  
 Durability, pipe:  
   cast iron soil pipe, of, 5-10  
 DWV Systems (*see* Drainage, Waste, Venting)

## E

Earth loads:  
   determination of, 71, 97  
 Economic advantages:  
   cast iron soil pipe, of, 9, 10  
   low-cost installation, in terms of, 10  
   performance, in terms of, 9  
   product availability, in terms of, 10  
   versatility, in terms of, 10

Effluent:  
   definition of, 159  
 Elastic limit:  
   definition of, 159  
 Erosion:  
   definition of, 159  
 Excavation:  
   building sewer, for, 61  
   deep-trench, 61  
   mechanical equipment, for, 61  
   safety precautions, and, 61  
   unstable soil, and, 61  
 Exfiltration:  
   cast iron soil pipe, and, 70  
   definition of, 70  
   problem of, 70  
 Existing work, plumbing in:  
   definition of, 159  
 Expansion:  
   pipe in, 169

## F

Firestopping, 134-136, 143-145  
 Fittings:  
   cast iron soil pipe, for, 17  
   casting of, 18  
   cleaning of, 24  
   coating of, 24  
   coremaking for, 21  
   definition of, 11  
   inspection and testing of, 24  
   mold used in production of, 18-21  
   molding techniques for, 18-21  
   molds for, illustration of, 20  
   permanent mold casting of, 23, 24  
   plumbing codes, and, 11  
   pouring of, 22  
   shaking out of, 22-23  
   symbols for, 166-167  
   technological advances in  
     production of, 29, 30  
 Fixture unit basis:  
   definition of, 159  
   plumbing fixtures, and, 60-62

use in sizing pipe, 60-61  
 Fixtures, plumbing:  
   battery of, 159  
   combination, 159  
   definition of, 159  
   fixture units, and, 60-62  
 Flaskless compress molding, 19, 20  
 Flasks:  
   cope of, 19, 20  
   drag of, 19, 20  
   machine molding in, 20  
   mold preparation, use in, 19, 20  
 Flood level rim:  
   definition of, 159  
 Flow and velocity:  
   cast iron soil pipe, in, 104  
 Flow capacity of cast iron soil pipe sewers and  
   drains, 100, 102  
 Flow in sewers and drains, 100, 102  
 Flushing, 151  
 Flushometer valve:  
   definition of, 159  
 Flush valve:  
   definition of, 159  
 Footing:  
   definition of, 159  
 Foran, John:  
   coremaking making, invention by, 4  
 Fordham University:  
 Industrial Economics Research Institute, xiv  
 Formulas for flow determination, 102  
 Foundry, cast iron soil pipe:  
   casting area of, 12  
   cleaning department of, 12  
   cleaning operations of, 24, 25  
   core room of, 13  
   cupola furnace of, 13-15  
   description of, 12, 13  
   finishing operations of, 24  
   molding area of, 12  
   molding operations, fittings, for, 18, 19, 20  
   patternmaking shop in, 29  
   pouring operations, fittings, for, 22  
   raw materials storage yard of, 13  
   shaking out operations, fittings, for, 22  
   static casting, modern, in, 18-24

  storage area of, 12  
   technological change in, 29-31  
   testing laboratory in, 24-28  
 Fractions to decimals:  
   conversion of, 185

## G

Galvanized steel pipe:  
   tests on, acoustical characteristics, for, 125  
 Gray iron:  
   chemical composition of, 16  
   metallurgical structure of, 6, 16  
   resistance to corrosion of, 6, 66  
   soil pipe manufacture, and, 12  
 Grinding equipment:  
   foundry use, for, 25  
 Green sand, 18

## H

Hangers, pipe:  
   beam clamps, 51  
   horizontal piping, suspended, and, 50  
   illustrations of, 51, 52  
   installation of, 50-54  
   spacing of, 51  
   vertical piping, and, 55  
 Heads of water:  
   pressure, corresponding to, 60  
 Horizontal piping:  
   hangers for, 50-52  
   installation instructions for, 50-54  
   supports for, 51-54  
 Horizontal Soil Support, 146  
 House sewer (*see* Building sewer and  
   Sewage systems)  
 Hub and spigot joint:  
   compression gaskets, use with, 8  
   installation instructions for, 45  
   invention of, 1  
   lead and oakum, use with, 9  
 Hubless coupling:  
   description of, 9  
   installation instructions for, 47  
   neoprene gaskets of, 9

soundproofing qualities of, 9  
 stainless steel clamp of, 8  
 test on, acoustical characteristics, for,  
 128  
 torque recommended for, 47

Hydrostatic test (*see* Water test)

## I

Individual vents:

definition of, 163  
 illustration, 41

Industrial construction:

cast iron soil pipe, use in, 4

Infiltration:

cast iron soil pipe, and, 69, 70  
 definition of, 69  
 problem of, 69, 70

Inspection:

house (building) sewer, of, 64  
 pipe systems, of, inside building, 57  
 soil pipe and fittings, of, 24  
 test plugs, illustration of, 59

Inspector, plumbing:

definition of, 161  
 test of plumbing system, and,  
 57, 58, 59, 64

Installation, cast iron soil pipe and fittings, of:

building (house) sewer, of, 61  
 compression joint, 45  
 condensate drain lines, for, 137-140  
 cost of, 10  
 hangers for, 51, 52  
 horizontal piping:  
   suspended, 51  
   underground, 61  
   hubless joint, 47  
 inside the building, 50  
 instructions for, general, 44-70  
 lead and oakum joint, 47-49  
 lead and oakum required for, 48  
 noise control, and, 123-131  
 performance of plumbing system, and, 5  
 sizing of pipe in, 60  
 supports for, 51  
 testing and inspection in, 57-59  
 vertical piping, 55

International Association of Plumbing and  
 Mechanical Officials, 155

Island Vent:

illustration, 41

## J

Joints, cast iron soil pipe:

characteristics of, 8  
 hubless coupling, 8, 47  
 compression joint, 8, 45  
 hub and spigot, 8  
 installation costs, and, 10  
 installation instructions for, 45-49  
 lead and oakum joint, 47-49  
 pipe length, and, 10  
 tests of, 57-59  
 versatility of, 10

## L

Laminar flow and turbulent flow, 101

Langensalza, German, 1

Layouts:

cast iron soil pipe, 32-43

Leaching Well, Definition, 160

Lead:

quantity required, cast iron soil pipe for, 48  
 specifications for, 48  
 use of, lead and oakum joint, in, 47-49

Lead and oakum joint:

caulking of, 49  
 condensate drains, and, 138  
 description of, 9  
 installation instructions for, 47-49  
 lead, use in, 47-49  
 oakum fiber, use in, 47-49  
 tests on, acoustical characteristics, for,  
 123-128

Lead Industries Association, 48

Lead pipe, 1

Leader, pipe:

definition of, 160

Limestone:

cupola-furnace process, use in, 13, 14  
 manufacture of cast iron soil, pipe,

used in, 13, 14

Loam cores:  
use prior to 1850, 2

## M

Main vent (*see* Vent stack)

Manholes:  
building (house) sewer, and, 64

Manufacture, cast iron soil pipe and fittings:  
capital invested in, 1890, 3  
companies engaged in, 11  
early, in United States, 2  
gray iron, used in, 12  
iron, type of, used in, 12  
materials handling equipment for, 30  
origins of, 1  
raw materials used in, 12, 132  
techniques, new, for, 29-31  
technology, and, 12, 29-31

Marking, 57

Marly-on-Seine, 1

Master plumber:  
definition of, 160

Materials handling equipment:  
foundry use, for, 30

Mechanical Contractors  
Association of America, 156

Mechanical impact compactors, 151

Melting section, foundry, of  
(*see* Cupola-furnace process)

Metals molds (*see* Molds)

Metric conversion factors, 187

Millville, New Jersey:  
first cast iron pipe foundry at, 2

Molding:  
area in foundry, for, 12  
centrifugal casting, and, 17  
cope used in, 19  
core prints, function of, in, 19  
drag used in, 19  
flaskless compression techniques,  
use in, 20  
flasks, in, 19  
machines for, 20

mechanization of, 20, 23, 24  
sand used in, 19, 20  
technological advances in, 29

Molds:  
centrifugal casting, for, 17  
dry sand, 2, 18  
fittings, for, preparation of, 19-21  
green sand:  
definition of, 18  
modern use, 18  
use prior to 1850, 2  
lubrication of, 18  
metal, water-cooled, 18  
permanent, fittings production, for, 23  
sand-lined, preparation of, 18-19  
technological change in preparation  
of, 29-31

## N

National Association of Plumbing Heating and  
Cooling Contractors, 156

National Board of Fire Underwriters, 156

National Bureau of Standards:  
abbreviation for, 156

National Fire Protective Association, 156

Neoprene  
control of vibration, and, 128-130  
hubless coupling, use in, 8  
joint seals, condensate drains,  
for, 137-140  
soundproofing qualities of, 126-131

No-Hub Coupling,  
see hubless coupling

Noble, Henry Jeffers, 1

Noise criteria curves:  
design tool, as, 123, 124

Noise, plumbing:  
cast iron, and, 123-131  
compression joint, and, 126-129  
control of, 126-131  
copper pipe, and, 124, 125  
definition of, 123  
galvanized steel pipe, and, 124, 125  
hubless coupling, and, 124-129

isolation breaks, and, 128  
 lead and oakum joint, and, 127  
 mass, relation to, 124, 125  
 measure of, 123  
 neoprene, and, 9, 128-131  
 piping materials, and, 123-131  
 piping wall, mass of, and, 124, 125  
 plastic pipe, and, 124-131  
 polysonics Acoustical Engineers,  
 and, 123-129  
 reduction of, 9, 123-129  
 serious nature of, 123  
 specifications to control, 131  
 vibration, and, 123-131

## O

Oakum fiber:  
 lead and oakum joint, role in, 9  
 quantity required, cast iron soil pipe, for, 48  
 use of, details on, 47-49  
 waterproofing characteristics of, 9

Offset:  
 definition of, 160

Offsets:  
 data for, 181, 189

On-side principle:  
 centrifugal casting, replacement by, 4  
 soil pipe production, of, 4

## P

Painting, cast iron soil pipe:  
 procedures for, 60

Pattern plates:  
 flaskless compression molding, and, 20

Patternmaking:  
 description of, 18, 19, 20  
 foundry shop for, 18  
 illustration of, 19  
 technological advances in, 29, 30

Peacock, George, 2

Peppermint test, piping systems for:  
 descriptions of, 59

Permanent mold casting:

description of, 23  
 fittings production, for, 23, 24  
 illustration of, 24  
 technological advance, and, 29

Pine-log pipe, 2

Pipe or pipes:

flexible, 81, 82  
 horizontal, definition of, 160  
 indirect waste, definition of, 160  
 local ventilating, definition of, 160  
 rigid, 81, 82  
 soil, definition of, 160  
 special waste, definition of, 160  
 vertical, definition of, 160  
 waste, definition of, 160  
 water distribution, definition of, 160  
 water riser, definition of, 160  
 water service, definition of, 160

Pipe equivalents, 184

Pipe stiffness, 147

Pitch, plumbing system:

definition of, 160

Plastic pipe:

allowable deflection of, 85  
 comparative cost, condensate drains,  
 for, 138, 140  
 compared to cast iron installed  
 underground, 81-87

tests on:

acoustical characteristics, for, 123-131  
 steam condensate drains, for, 137-140

Plumbing:

definition of, 161

Plumbing codes:

cast iron soil pipe fittings, and, 3  
 combination sewers, and, 33  
 definition of, 158  
 early municipal codes, 1880's, 3  
 horizontal pipe supports, and, 50-52  
 sewer connection, and, 70  
 sizing of pipes, and, 60  
 stack supports, and, 53, 55  
 storm drains, and, 32  
 test of plumbing system, and, 57-59

Plumbing Drainage Institute, 156

Plumbing inspector:

definition of, 161  
 Polyethylene Encasement, 66-69  
 Polysonics Acoustical Engineers:  
   plumbing noise studied by,  
   report of, 123-129  
 Pouring:  
   description of, 22  
   fittings production in, 26  
   materials handling equipment for, 30  
 Precipitation:  
   definition of, 161  
 Premises governing flow determination, 101, 102  
 Pressure concentration factor, 96  
 Private use:  
   definition of, 161  
 Production, cast iron soil pipe and fittings  
   (*see* Manufacture)  
 Public use:  
   definition of, 161  
*Public Works Magazine*, 70  
 Putrefaction:  
   definition of, 161

## R

Raw materials:  
   manufacture of cast iron soil pipe,  
     used in, 12, 132  
   materials handling equipment,  
     moving, or, 30  
   radiation Detection for, 12  
   storage yard for, foundry, at, 3, 12  
   selection of, 12, 132  
 Residential construction:  
   availability, 122  
   cost, 121  
   expansion and contraction, 121  
   noise, 120  
   specifying, 122, 141  
   strength and durability, 121  
   value, 122  
 Revent:  
   definition of, 161  
 Right triangle:  
   solution of, 186  
 Ring design, 91

Roof drains:  
   cast iron soil pipe, and, 32, 33  
   flashing, and, 33  
   illustration of, 33  
   layouts for, 35  
   leaders for, horizontal and vertical, 32, 33  
   sewer gas, and, 32  
   traps, and, 32, 36  
 Roof leaders:  
   cast iron boots, and, 32, 33  
   cast iron soil pipe, used for, 33  
   illustration of, 33  
   sizing of, statistical information for, 33  
 Roughing in:  
   definition of, 161

## S

Safety factor, soil pressure, 147  
 Sand slinger:  
   mold preparation, use in, 20  
 Sand-lined molds (*see* Molds)  
 School construction:  
   cast iron soil pipe, use in, 5  
 Scrap iron and steel:  
   cupola-furnace process, use in, 13  
   early use in pipe production, 3  
   manufacture of cast iron soil pipe,  
     used in, 13, 132  
   selection of, proper, 12, 13  
 Septic tanks:  
   building drain connected to, 5, 6  
   building (house) sewer, and, 38, 61  
   definition of, 161  
   illustrations of, 38  
   layouts for, 38  
 Sewage:  
   clarified, definition of, 158  
   crude or raw, definition of, 158  
   definition of, 161  
   domestic, definition of, 159  
   fresh, description of, 160  
   oxidized, definition of, 160  
   septic, definition of, 161  
   stale, definition of, 162  
 Sewage systems:

- building (house) sewer:
  - definition of, 161
  - inspection of, 57-59, 64
  - testing of, 57-59, 64
  - maintenance of, 65
- building storm sewer, definition of, 161
- city sewer, 61, 64
- cleanouts, and, 64
- combination sewers, 32, 35
- house sewers, septic tanks, and, 38,61
- installation of in 1890's, 1
- lateral sewer, definition of, 160
- main or trunk sewer, definition of, 160
- outfall sewers, definition of, 160
- private sewer, definition of, 161
- sanitary sewers, 161
- storm sewers, 32, 161
- sub-main sewer, definition of, 162
- traps, and storm sewers, 36
- Sewage treatment plants:
  - digester in, definition of, 159
  - problems at, 69, 70
  - signs of abrasion in piping, and, 7
  - storm drainage, and, 32
- Sewer (*see* Sewage systems)
- Sewer gas:
  - control of, 32
  - roof drains, and, 32, 37
- Shaking-out:
  - description of, 22
- Simpson, Sir Thomas, 1
- Sizing, pipe of:
  - clogging, and, 65
  - fixture unit basis, and, 60-63
  - procedures used for, 60
- Slick:
  - definition of, 162
- Sloss-Sheffield Steel and Iron Company, 1
- Sludge:
  - definition of, 162
- Smoke test, piping systems for:
  - description of, 59
- Soil stack, cast iron:
  - definition of, 5
- Soundproofing:
  - neoprene, and, 9, 123-131
  - plumbing systems, in, 9, 123-131
- Southern Building Code Congress International, 157
- Specifications, cast iron soil pipe:
  - Washington, D.C., plumbing code, 1881, in, 3
- Sprues:
  - pouring operations, and, 22
- Squeeze plate:
  - flaskless compression molding, and, 20
- Stack vent:
  - illustration of, 39
- Stainless steel pipe:
  - comparative cost, condensate drain lines, for, 138
  - condensate lines, use in, 137
- Standardization, cast iron soil pipe:
  - early standard sizes, 3
  - specifications covering, 1880's, 3
- Static sand casting:
  - modern methods of, 18, 19, 20
- Steam condensate drain lines
  - (*see* Condensate drain lines)
- Storm drainage (*see* Drainage)
- Strain:
  - definition of, 162
- Structural design of buried cast iron soil pipe, 88
- Summary and conclusions, Deep Burial, 88
- Sump:
  - definition of, 162
  - sub-soil drains, and, 32
- Supports, pipe (*see* Hangers, pipe)
- Symbols, plumbing, 164-168

## T

- Tank capacities:
  - cylindrical, 173-176
  - rectangular, 177-178
  - tapered, 179-180
- Technological improvements:
  - foundry practice, in, 29-30
  - results of, 31



Temperatures:  
 condensate, 137  
 cupola-furnace, in, 15  
 extremes and piping materials, 5  
 plastic pipe adhesive, of, 138  
 test, condensate drain lines, for, 139

Tension:  
 definition of, 162

Test plugs:  
 illustrations of, 59

Test tees:  
 illustration of, 59

Testing:  
 air pressure test, pipe systems, for, 57-58  
 house (building) sewer, of, 64  
 illustration of, 26-28  
 metallurgy, and, 18  
 peppermint test, pipe systems, for, 59  
 pipe systems, of, inside, building, 57-60  
 smoke test, pipe systems, for, 59  
 soil pipe and fittings, of, 24  
 test plugs, illustration of, 59  
 water test, pipe systems, for, 58, 60

Three-edge bearing formula, 91

Trap seal:  
 definition of, 162  
 storm drains, of, 36

Traps:  
 cast iron for, 32  
 combination sewers, and, 32, 36  
 definition of, 162  
 roof drainage, and, 32, 36

Trench Preparation:  
 plastic pipe compared to C.I. pipe, 81-84

Trenching Recommendations, 71-80

Turbulence:  
 definition of, 162

Tyler Pipe Company, 11

## U

determination of expected loads and crush values, 85

Underground piping:  
 definition of, 84

Uniform Plumbing Code, 157

United States Department of Commerce, 11, 100, 192

United States Department of the Interior, 1, 3

Uses, cast iron soil pipe:  
 general applications, 5  
 versatility of, 10

## V

Vacuum:  
 definition of, 162

Valves, symbols for, 166-167

Velocity:  
 abrasion, and, 7  
 definition of, 162

Velocity and flow:  
 cast iron soil pipe in, 100-118

Vent stack:  
 definition of, 163  
 illustration of, 39

Vent terminal:  
 illustration of, 39

Venting:  
 battery of fixtures, for, 36  
 circuit vent, definition of, 162  
 common vent, definition of, 162  
 continuous vent, definition of, 162  
 individual vents, definition of, 163  
 vent lines, sizing of, 60  
 vent stack, cast iron, definition of, 163  
 vent system, definition of, 162  
 wet vent, definition of, 163

Venting systems (*see* Venting)

Vents (*see* Venting)

Versailles, France, 1

Vertical piping:  
 instructions for, 50, 55  
 supports for, 50, 55

Vertical soil pressure, 96, 97

Vibrating for soil compaction, 151

Vibration:  
 plumbing noise, and, 123-131

## W

### Waste:

definition of, 163

### Water test, piping systems for:

description of, 58, 60

house (building) sewer, and, 64

### Water works:

installations of in 1890's, 4

### Weights and measures, 188

### West Point, New York:

early foundry at, 1

### Wet vent:

definition of, 163

illustration of, 40

### Weymouth, New Jersey:

blast furnace at, 2

first pipe manufacturer at, 2

### Wooden pipe, 2

## Y

### Yoke vent:

definition of, 163